

DOCTORAL (PhD) DISSERTATION

UYEN THANH HOANG TON

**HUNGARIAN UNIVERSITY OF AGRICULTURE AND
LIFE SCIENCES - KAPOSVÁR CAMPUS**

**DOCTORAL SCHOOL IN MANAGEMENT AND
ORGANIZATIONAL SCIENCES**

2022



**HUNGARIAN UNIVERSITY OF AGRICULTURE AND
LIFE SCIENCES - KAPOSVÁR CAMPUS**

**DOCTORAL SCHOOL IN MANAGEMENT AND
ORGANIZATIONAL SCIENCES**

Head of Doctoral School

Prof. Dr. IMRE FERTÖ DSc

Supervisor

Dr. TIBOR TATAY

Associate Professor

**THE IMPACT OF MONETARY POLICY ON STOCK
MARKET LIQUIDITY IN EMERGING MARKET
ECONOMIES**

Written by

UYEN THANH HOANG TON

KAPOSVÁR

2022

CONTENTS

CHAPTER 1	1
INTRODUCTION	1
1.1. BACKGROUND OF THE STUDY	1
1.2. SCOPE AND FOCUS OF THE STUDY	2
1.3. PROBLEM STATEMENT	3
1.4. SIGNIFICANCE OF THE STUDY	4
1.5. RESEARCH QUESTIONS	5
1.6. RESEARCH OBJECTIVES	6
1.7. MODEL OF THE STUDY	7
1.8. DISSERTATION STRUCTURE	8
1.9. DEFINITION OF TERMS	9
CHAPTER 2	12
RESEARCH METHODOLOGY	12
2.1. RESEARCH DESIGN	13
2.2. OPERATIONALISATION OF VARIABLES	13
2.2.1. <i>Explanatory variable</i>	13
2.2.2. <i>Explained variable</i>	14
2.2.3. <i>Control variable</i>	14
2.3. DESCRIPTION OF THE STUDY AREA	15
2.4. POPULATION AND SAMPLING PROCEDURE	15
2.5. DATA COLLECTION PROCEDURE	16
2.6. DATA ANALYSIS PROCEDURE	17
2.6.1. <i>Variable calculation</i>	17
2.6.2. <i>Data transformation</i>	17
2.6.3. <i>Descriptive statistics</i>	18
2.6.4. <i>Classic assumption tests</i>	18
2.6.5. <i>Model specification</i>	19
2.6.6. <i>Regression diagnostics concerning the characteristics of the selected panel data models</i>	20
2.6.7. <i>Estimation of the selected research model</i>	20
CHAPTER 3	21
MONETARY POLICY AND STOCK MARKET LIQUIDITY IN EMERGING MARKET ECONOMIES: A LITERATURE REVIEW	21
3.1. INTRODUCTION	22
3.2. MONETARY POLICY MEASURES AND TRANSMISSION MECHANISM OF MONETARY POLICY AND STOCK MARKET	23
3.2.1. <i>Monetary policy measures</i>	23

3.2.2. <i>Transmission mechanism of monetary policy and stock market</i>	25
3.3. STOCK MARKET LIQUIDITY MEASURES AND FACTORS IMPACTING STOCK MARKET LIQUIDITY	27
3.3.1. <i>Stock market liquidity measures</i>	27
3.3.2. <i>Factors impacting stock market liquidity</i>	29
3.4. EMERGING MARKET ECONOMIES	31
3.5. DISCUSSION ON THE RELATIONSHIP OF MONETARY POLICY AND STOCK MARKET LIQUIDITY IN EMERGING MARKET ECONOMIES	33
3.6. CONCLUSION	35
CHAPTER 4.....	36
MODELLING IMPACT OF MONETARY POLICY ON STOCK MARKET LIQUIDITY IN EMES DURING CRISIS AND NON-CRISIS PERIODS: A FEM APPROACH.....	36
4.1. INTRODUCTION	37
4.2. RELATED LITERATURE REVIEW	39
4.2.1. <i>Monetary policy and stock market liquidity in emerging market economies during Crisis and Non-crisis times</i>	39
4.2.2. <i>Interest rate and stock market liquidity</i>	41
4.2.3. <i>Monetary aggregates and stock market liquidity</i>	42
4.2.4. <i>Exchange rate and stock market liquidity</i>	44
4.2.5. <i>Economic growth rate and stock market liquidity</i>	45
4.2.6. <i>Inflation rate and stock market liquidity</i>	46
4.2.7. <i>The Treasury bill rate and stock market liquidity</i>	47
4.3. RESEARCH DATA AND MODEL	48
4.3.1. <i>Data set</i>	48
4.3.2. <i>Explained variable: Stock market liquidity measures</i>	49
4.3.3. <i>Explanatory variable: Monetary policy measures</i>	49
4.3.4. <i>Control variables</i>	50
4.3.5. <i>Research model</i>	51
4.4. RESEARCH METHODOLOGY	53
4.5. EMPIRICAL ANALYSIS AND DISCUSSIONS	56
4.5.1. <i>Descriptive statistics</i>	56
4.5.2. <i>Classic regression diagnostic tests</i>	59
4.5.3. <i>Preliminary tests concerning panel regression diagnostics</i>	62
4.5.4. <i>Fixed-Effects Model regression</i>	63
4.5.5. <i>Feasible Generalized Least Squares regression</i>	69
4.6. CONCLUSIONS AND RECOMMENDATIONS.....	73
4.7. LIMITATIONS	76
CHAPTER 5.....	77
THE CAUSAL LINKAGE BETWEEN MONETARY POLICY AND STOCK MARKET LIQUIDITY IN EMES: A PANEL CS-ECM APPROACH	77
5.1. INTRODUCTION	78
5.2. LITERATURE REVIEW	80

5.2.1. <i>The causal relationship between monetary policy and stock market liquidity in emerging market economies</i>	80
5.2.2. <i>Interest rate and stock market liquidity</i>	82
5.2.3. <i>Monetary aggregates and stock market liquidity</i>	83
5.2.4. <i>Exchange rate and stock market liquidity</i>	85
5.2.5. <i>Economic growth rate and stock market liquidity</i>	86
5.2.6. <i>Inflation rate and stock market liquidity</i>	89
5.2.7. <i>The Treasury bill rate and stock market liquidity</i>	91
5.3. DATA AND METHODOLOGY	92
5.4. EMPIRICAL ANALYSIS AND DISCUSSIONS	97
5.4.1. <i>Descriptive analysis</i>	97
5.4.2. <i>Stationarity test</i>	98
5.4.3. <i>Cross-sectional dependence test</i>	100
5.4.4. <i>Panel cointegration test</i>	101
5.4.5. <i>Granger causality test</i>	102
5.4.6. <i>CS-ECM estimation</i>	108
5.5. CONCLUSIONS AND RECOMMENDATIONS	115
5.6. LIMITATIONS AND FUTURE RESEARCH	122
CHAPTER 6	124
DISCUSSIONS AND CONCLUSIONS	124
6.1. OVERALL DISCUSSION AND CONCLUSIONS	124
6.2. THEORETICAL IMPLICATIONS	131
6.3. PRACTICAL IMPLICATIONS.....	132
6.4. LIMITATIONS AND FUTURE RESEARCH.....	134
THE NEW SCIENTIFIC RESULTS	136
SUMMARY	139
ACKNOWLEDGEMENT	141
REFERENCES	143
PUBLICATIONS RELATED/ NOT RELATED TO THE TOPIC OF THE DISSERTATION	172
<i>Publications related to the dissertation</i>	172
<i>Publications not related to the dissertation</i>	172
<i>Books</i>	172
<i>Full papers in conference proceedings</i>	172
<i>Abstracts in Conference proceedings</i>	173
CURRICULUM VITAE	174

LIST OF TABLES

TABLE 2.1. CATEGORISATION OF INDICATORS OF SML, MOP AND CONTROL VARIABLES	14
TABLE 2.2. THE LIST OF MAJOR STOCK EXCHANGES IN SEVEN SELECTED EMES	178
TABLE 4.1. SUMMARY OF ASYMPTOTIC BEHAVIOR REQUIRED T AND N FOR THE DERIVATION OF THE LIMITING DISTRIBUTION OF THE TESTS	188
TABLE 4.2. DESCRIPTIVE STATISTICS FOR ALL VARIABLES IN SEVEN SELECTED STOCK MARKETS, 2000 - 2018 (133 STOCK MARKET-YEAR OBSERVATIONS)	191
TABLE 4.3. PAIRWISE CORRELATION FOR SML VARIABLES, MOP VARIABLES AND CONTROL VARIABLES IN SEVEN SELECTED STOCK MARKETS, 2000-2018.....	199
TABLE 4.4. VARIANCE INFLATION FACTOR (VIF) TEST FOR MULTICOLLINEARITY.....	201
TABLE 4.5. A MODEL SPECIFICATION LINK TEST FOR EACH SML VARIABLE.....	201
TABLE 4.6. REGRESSION SPECIFICATION ERROR TEST (RESET) FOR OMITTED VARIABLES FOR EACH SML VARIABLE	201
TABLE 4.7: CROSS SECTIONAL DEPENDENCY TEST FOR EACH SML VARIABLE (BREUSCH- PAGAN LM TEST).....	202
TABLE 4.8: PANEL UNIT ROOTS TEST FOR EACH VARIABLE.....	202
TABLE 4.9: TIME-FIXED EFFECTS TESTS FOR EACH SML VARIABLE	205
TABLE 4.10: HETEROSKEDASTICITY OF WALD TEST.....	206
TABLE 4.11: SERIAL CORRELATION OF WOOLDRIDGE TEST.....	206
TABLE 4.12: ENDOGENEITY TESTS WITH CONTROL VARIABLES	206
TABLE 4.13: PANEL FIXED EFFECTS USING INTERACTION WITH FCT (WITH CONTROL VARIABLES)	207
TABLE 4.14: FGLS REGRESSION USING AND INTERACTION WITH FCT (WITH CONTROL VARIABLES)	208
TABLE 5.1: SUMMARY OF THE FIRST-GENERATION PANEL UNIT ROOT TESTS AND FORMULAS	212
TABLE 5.2: FIRST-GENERATION PANEL UNIT ROOT TESTS FOR EACH VARIABLE.....	225
TABLE 5.3: SECOND-GENERATION PANEL UNIT ROOT TEST FOR EACH VARIABLE	226
TABLE 5.4: CROSS-SECTIONAL DEPENDENCY TEST FOR EACH SML VARIABLE.....	227
(BREUSCH-PAGAN LM TEST).....	227
TABLE 5.5: CROSS SECTIONAL DEPENDENCY TEST FOR EACH SML VARIABLE (CD TEST)	227
TABLE 5.6: COINTEGRATION TEST FOR MOP AND SML VARIABLES	228
TABLE 5.7: PANEL GRANGER NON-CAUSALITY TEST (DUMITRESCU AND HURLIN TEST (2012))	233
TABLE 5.8: DYNAMIC COMMON CORRELATED EFFECTS ESTIMATOR - MEAN GROUP (CS- ECM) FOR MEC	238

TABLE 5.9: DYNAMIC COMMON CORRELATED EFFECTS ESTIMATOR - MEAN GROUP (CS-ECM) FOR LNQ.....	239
TABLE 5.10: DYNAMIC COMMON CORRELATED EFFECTS ESTIMATOR - MEAN GROUP (CS-ECM) FOR LNV.....	240
TABLE 5.11: DYNAMIC COMMON CORRELATED EFFECTS ESTIMATOR - MEAN GROUP (CS-ECM) FOR LOGSRELLOG.....	242
TABLE 5.12: DYNAMIC COMMON CORRELATED EFFECTS ESTIMATOR - MEAN GROUP (CS-ECM) FOR LNSEFF.....	243
TABLE 5.13: DYNAMIC COMMON CORRELATED EFFECTS ESTIMATOR - MEAN GROUP (CS-ECM) FOR LNN.....	244
TABLE 5.14: DYNAMIC COMMON CORRELATED EFFECTS ESTIMATOR - MEAN GROUP (CS-ECM) FOR LNN.....	246
TABLE 5.15: DYNAMIC COMMON CORRELATED EFFECTS ESTIMATOR - MEAN GROUP (CS-ECM) FOR LNHHI.....	247

LIST OF FIGURES

FIGURE 1.1. PROPOSED RESEARCH MODEL APPROACHES	7
FIGURE 3.1. THE LINK BETWEEN MONETARY POLICY AND AGGREGATE DEMAND: MONETARY TRANSMISSION MECHANISM	182
FIGURE 3.2. DEFINITIONS AND MEASURES OF STOCK MARKET LIQUIDITY	183
FIGURE 3.3. FACTORS IMPACTING STOCK MARKET LIQUIDITY	183
FIGURE 3.4. REAL GDP GROWTH OF EMERGING MARKET AND DEVELOPING ECONOMIES (2000, 2018 AND 2021).....	184
FIGURE 3.5. THE RELATIONSHIP BETWEEN MONETARY POLICY AND STOCK MARKET	184
FIGURE 3.6. THE RELATIONSHIP BETWEEN MONETARY POLICY AND STOCK MARKET LIQUIDITY IN EMES	185
FIGURE 4.1. EMPIRICAL IMPACT OF MONETARY POLICY ON STOCK MARKET LIQUIDITY IN EMES AND HYPOTHESES (H1)	186
FIGURE 4.2. EMPIRICAL IMPACT OF EACH VARIABLE OF MONETARY POLICY ON STOCK MARKET LIQUIDITY IN EMES AND HYPOTHESES (FROM H2 TO H7)	187
FIGURE 4.3. TREND OF MOP AND SML IN EMES DURING THE CRISIS TIME (2007-2009)	188
FIGURE 4.4. TREND OF MOP AND SML IN EMES DURING THE NON-CRISIS TIME (2000- 2006 AND 2010-2018)	190
FIGURE 4.5. AN AUGMENTED COMPONENT-PLUS-RESIDUAL PLOT OF MEC, LNQ, LNV, LOGSRELLOG, LNSEFF, LNN, LNN AND LNHHI	194
FIGURE 4.6. AN ADDED-VARIABLE PLOT MEC, LNQ, LNV, LOGSRELLOG, LNSEFF, LNN, LNN AND LNHHI	197
FIGURE 4.7. A STANDARDIZED NORMAL PROBABILITY (P-P) PLOT OF STOCK MARKET LIQUIDITY MEASURES (MEC, LNQ, LNV, LOGSRELLOG, LNSEFF, LNN, LNHHI) .	198
FIGURE 4.8. A STANDARDIZED NORMAL PROBABILITY (P-P) PLOT OF MONETARY POLICY MEASURES AND CONTROL VARIABLES (INRR, MB, LNEXR, GDPR, CPI, LNTBR, LNMAC, FIG)	198
FIGURE 5.1: CAUSAL LINKAGE BETWEEN MONETARY POLICY AND STOCK MARKET LIQUIDITY IN EMES AND HYPOTHESES (H1, H2 AND H3).....	209
FIGURE 5.2: CAUSAL LINKAGE BETWEEN MONETARY POLICY AND STOCK MARKET LIQUIDITY IN EMES AND HYPOTHESES (H4 AND H5).....	210
FIGURE 5.3: CAUSAL LINKAGE BETWEEN MONETARY POLICY AND STOCK MARKET LIQUIDITY IN EMES AND HYPOTHESES (H6 AND H7).....	211
FIGURE 5.4: TREND OF MOP AND SML IN SEVEN SELECTED COUNTRIES OF EMES FROM 2000 TO 2018.....	224
FIGURE 5.5: GRANGER CAUSALITY BETWEEN MOP AND SML IN SEVEN SELECTED COUNTRIES OF EMES FROM 2000 TO 2018	237

LIST OF APPENDICES

CHAPTER 2: APPENDICES.....	175
APPENDIX 2.A. DEFINITION OF STOCK MARKET LIQUIDITY MEASURES.....	175
APPENDIX 2.B. DEFINITION OF MONETARY POLICY MEASURES	177
APPENDIX 2.C. THE LIST OF MAJOR STOCK EXCHANGES IN SEVEN SELECTED EMES	178
APPENDIX 2.D. DESCRIPTION OF THE SEVEN SELECTED STOCK EXCHANGES	179
CHAPTER 3: APPENDICES.....	182
APPENDIX 3.A. TRANSMISSION MECHANISMS OF MONETARY POLICY AND STOCK MARKET	182
APPENDIX 3.B. STOCK MARKET LIQUIDITY MEASURES AND FACTORS IMPACTING STOCK MARKET LIQUIDITY	183
APPENDIX 3.C. EMERGING MARKET ECONOMIES.....	184
APPENDIX 3.D. THE RELATIONSHIP OF MONETARY POLICY AND STOCK MARKET LIQUIDITY IN EMES	184
CHAPTER 4: APPENDICES.....	186
APPENDIX 4.A. MONETARY POLICY AND STOCK MARKET LIQUIDITY IN EMES AND HYPOTHESES	186
APPENDIX 4.B. PANEL UNIT ROOT TESTS	188
APPENDIX 4.C. DESCRIPTIVE STATISTICS	188
APPENDIX 4.D. CLASSIC REGRESSION DIAGNOSTIC TESTS	192
APPENDIX 4.E. PRELIMINARY TESTS CONCERNING PANEL REGRESSION DIAGNOSTICS	202
APPENDIX 4.F. FIXED EFFECTS MODEL REGRESSION.....	207
APPENDIX 4.G. FEASIBLE GENERALIZED LEAST SQUARES REGRESSION	208
CHAPTER 5: APPENDICES.....	209
APPENDIX 5.A. CAUSAL LINKAGE BETWEEN MONETARY POLICY AND STOCK MARKET LIQUIDITY IN EMES AND HYPOTHESES	209
APPENDIX 5.B. DESCRIPTION OF ANALYSIS STRATEGY.....	212
APPENDIX 5.C. DESCRIPTIVE ANALYSIS	218
APPENDIX 5.D. STATIONARITY TEST	225
APPENDIX 5.E. CROSS-SECTIONAL DEPENDENCY TEST	227
APPENDIX 5.F. PANEL COINTEGRATION TEST	228
APPENDIX 5.G. GRANGER CAUSALITY TEST	233
APPENDIX 5.H. CS-ECM ESTIMATION	238

ABBREVIATIONS

ARIMA	:	Autoregressive Integrated Moving Average
CPI	:	Consumer price index
CS-ECM	:	The Cross-Sectionally augmented Error Correction Model
DeM	:	Market Depth
DiM	:	Market Diversity
ECM	:	Error Correction Model
EMEs	:	Emerging Market Economies
EXR	:	Exchange rate
FEM	:	Fixed-Effects Model
FGLS	:	Feasible Generalized Least Squares
FIG	:	Financial globalisation
GARCH	:	Generalised Autoregressive Conditional Heteroskedasticity
GDP	:	Gross Domestic Product
GDP _r	:	Real Gross Domestic Product
GFC	:	Global Financial Crisis
HPAC	:	Heteroskedasticity, Panel Autocorrelation and contemporaneous Correlation
ImM	:	Market Immediacy
INR _r	:	Real Interest Rate
MAC	:	Market capitalisation
MB	:	Money Base
MOP	:	Monetary policy
OLS	:	Ordinary Least Squares

OTC	:	Over-the-counter
PCSE	:	Panel-Corrected Standard Errors
ReM	:	Market Resiliency
RESET	:	Regression Specification Error Test
SML	:	Stock market liquidity
SSE	:	Sustainable Stock Exchanges
TBR	:	Treasury bills rate
TiM	:	Market Tightness
VAR	:	Vector Autoregressive
VECM	:	Vector Error Correction Model
VIF	:	Variance Inflation Factors
WLS	:	Weighted least squares
WPI	:	Wholesale Price Index

CHAPTER 1



INTRODUCTION

1.1. BACKGROUND OF THE STUDY

Analysing the role of macroeconomic policies in the development of financial markets and the practical cases can provide a valuable reference for the applied policies in financial markets. Indeed, in macroeconomic policies, MOP always plays a crucial role in each country's economy, pursuing significant targets, including price stability, economic growth, and full employment. It is said that changes in MOP in the short or long term are known as one of the primary reasons causing different movements of funds flows in the investment channels via direct finance (directly from financial markets) and indirect finance (indirectly from financial intermediaries). The stock market - a type of financial market - is one of the most vital areas of an economy, with an essential economic function providing significant capital for an economy. In reality, the conduct of MOP has significantly affected the stock market performance and development in general and SML in specific (e.g. Fujimoto & Watanabe, 2004; Goyenko & Ukhov, 2009; Octavio et al., 2013; Chu, 2015; Jieun et al., 2016; Kurihara, 2017; Chowdhury et al., 2018; Debata & Mahakud, 2018; and others).

Accordingly, in EMEs, the terms “monetary policy” and “stock market liquidity” are the first attention of investors who try to get back capital and make the best profit on their investment or regulators who look for and ensure economic growth. It is clearly seen that these issues have become crucial in recent decades as EMEs are taking a more significant

force and role in the global economy. In the wake of the 2007-2009 GFC, developed countries slowly recovered, and emerging and developing countries continued to lead global economic growth, contributing about 80% of GDP growth and 85% of consumption growth. It is a favourable factor creating optimistic prospects for the world economy, but the main characteristics of EMEs cause investors deep concerns when making investment decisions. Moreover, the MOP role has broadened as the economic structure and the changes in the structure of financial markets have become more complex, specifically since the GFC of 2007-2009. Take China as an example; China's Stock Market Crash in 2015, including 190% growth in a year and a 30% decline in a month, is a meaningful lesson for EMEs regarding the lack of uniformity and tightness in economic operations. However, it is not easy to reduce the probability of stock market crashes (financial collapses), increase SML or conduct the MOP effectively in EMEs in the era of globalisation.

To conclude, there are two important motivations for this research. First, theoretically in MOP and the stock market, the research complements "a small part" of a research model in the empirical literature. Second, empirically, the research provides practical implications for MOP influence on SML in EMEs. More specifically, it provides comprehensive insight and indicates a good understanding of the relationship between MOP and SML in the selected EMEs context. The research's findings have the potential to support not only the investors making their decisions in the stock markets but also the regulators and policymakers in improving the effectiveness of MOP in the financial system.

1.2. SCOPE AND FOCUS OF THE STUDY

With the increase in the effects of financial globalisation on the economy in general and financial markets (e.g. a stock market) in particular at the

country level, there has been a corresponding increase in its incorporation in the MOP implementation, especially in EMEs. Accordingly, the GFC of 2007-2009 has ample evidence to illustrate the consequences of overheating the economy and macro-financial imbalances and refer to the period of extreme stress in global financial markets. Given this situation, the research assesses the role of MOP on the SML in EMEs and their correlations, especially during Crisis and Non-crisis periods. To this end, the research will cover MOP's impact on SML from 01st Jan 2000 to 31st Dec 2018. The scope of the research is identified to comprehensively capture the overall influence of MOP on main SML characteristics. In addition, the empirical analyses in this research are restricted to seven selected major stock exchanges located across seven EMEs.

1.3. PROBLEM STATEMENT

The general problem addressed in this research is “the correlation between macroeconomic performance (i.e. MOP), financial markets (i.e. SML), EMEs and the globalisation phenomenon (i.e. a financial globalisation)”. In other words, the author considers whether MOP influences SML in EMEs, whether financial globalisation affects the linkage of MOP and SML in EMEs and which MOP indicator affects SML in EMEs in normal and turbulent periods in the short and long run. Besides, the author presumes whether MOP's relation is causal and exists in the short and long term. Furthermore, the Global Financial and Economic Crisis of 2007-2009, which surprised many economists and financial authorities, indicated a deficiency of the classical and neoclassical approach to understanding financial problems in the economy (Kolozsi, 2013). Additionally, the literature has not addressed the overall impact of MOP on the equity market in general and the stock market liquidity in particular. As a result, the specific problem in this

research is the overall impact of MOP aspects on each major SML characteristic in EMEs, especially during Crisis and Non-crisis times. Also, the research discovers the relationship between MOP and SML in the short and long run and their causality.

It is crucial to address this problem because the effect of MOP on the economy and economic resource allocation via the stock market is significant. This research empirically provides specific answers to the problem.

1.4. SIGNIFICANCE OF THE STUDY

Implementing macroeconomic policies in the financial system has become a critical topic concerning the macroeconomic management of each country, especially after the whole world has fallen into the GFC. More specifically, in the era of financial globalisation, the government and monetary authority (i.e. a Central Bank) need to understand the considerable role of financial markets and flexibly implement macro-control measures to enhance the role of macroeconomic policies in the development of financial markets. Many economists consider the MOP the most critical macroeconomic policy (Maskay, 2007). Any changes in MOP by a Central Bank might change the future outlook of the economy and the financial markets' performance (especially the stock market) in each country and worldwide.

Empirical research shows that the linkage between MOP and SML is complex and overwhelming in EMEs (e.g. Chu, 2015; Rehman et al., 2016; Herwany et al., 2017; Anup, Uddin, & Anderson, 2018; Debata & Mahakud, 2018). To the best of the author's knowledge, the crucial role of MOP and SML in EMEs has been considerably perceived in the empirical literature. However, there is a lack of systematic studies investigating the overall impact of MOP on all SML characteristics in

EMEs (especially during Crisis and Non-crisis periods) at the country level with panel data employing different model approaches.

Therefore, the research enriches the empirical literature on the MOP-SML nexus in EMEs and concedes the Central Bank's essential role through its MOP implementation. In terms of macroeconomic management (particularly in macroeconomic and financial stability), the findings of this research can help Central Banks perceive the forward-leading importance of MOP and be better prepared if the economy experiences another deep and prolonged recession. This preparedness can assist Central Banks in assessing the impact of MOP on the stock market and thus preempting stock market crashes. Regarding the positive social impact of the research, the findings can help investors make more informed investment decisions, leading to a better allocation of economic resources. The findings would be a rational premise for SML predictability in EMEs during Crisis and Non-crisis periods in the future via the MOP role.

1.5. RESEARCH QUESTIONS

The following groups of research questions are identified and addressed to guide the acquisition of data required to satisfy the problem statement:

1. To what extent does MOP affect SML in EMEs based on the theoretical and empirical literature?

- How is the transmission mechanism of MOP and the stock market?
- What are the different MOP properties that can influence SML?
- What are the measures of the significant SML characteristics?
- How are the impacts of MOP on SML in EMEs?

Answering this question will achieve the overall aim and specific objectives 1.

2. To what extent does MOP affect SML in EMEs during Crisis (2007-2009) and Non-crisis (2000-2006, 2010-2018) periods?

- Does MOP crucially matter for SML in EMEs?
- Does the impact of MOP on SML in EMEs vary from normal (Non-crisis) to turbulent (Crisis) periods?
- What are the essential indicators of MOP influencing SML in EMEs during the Crisis and Non-crisis periods?

Answering this question will achieve the overall aim and specific objectives 2 and 3.

3. To what extent do MOP's short- and long-run effects on SML, and their causality exist in EMEs from 2000 to 2018?

- Is there causality between MOP and SML in EMEs from 2000 to 2018?
- How does MOP affect SML in EMEs in the short and long run over the period between 2000 and 2018?

The answer to this question will address objective 4.

1.6. RESEARCH OBJECTIVES

The general objective of this research is to evaluate and determine the impact of MOP on SML at the country level in the selected major stock exchanges of the seven EMEs in the Crisis and Non-crisis periods from 2000 to 2018, along with the consideration of causality. Thereby, the findings regard recommendations for researchers, regulators, policymakers, and investors. It is achieved through the specific objectives as follows:

1. To systematise the different theoretical properties of MOP that can influence SML in EMEs and the association between MOP and SML in theory and practice.
2. To develop a theoretical model of the relationships between the MOP's variables and SML in EMEs.

3. To assess the proposed model empirically and discover the linkage of Cris MOP and SML in EMEs, especially during crisis and Non-crisis periods.
4. To identify and empirically evaluate the effect of MOP on SML in EMEs in the short and long run and their causality.

1.7. MODEL OF THE STUDY

In this research, the author conducts two different models to investigate the impact of MOP on SML in EMEs from 2000 to 2018, including FEM (a static model approach) and CS-ECM (a dynamic model approach). Accordingly, the relationship between MOP and SML in EMEs is considered to address adequately with different approaches. To clarify, the findings obtained from the models provide sight of the big picture of the impact of MOP and SML in EMEs during the research period. (See Figure 1.1)

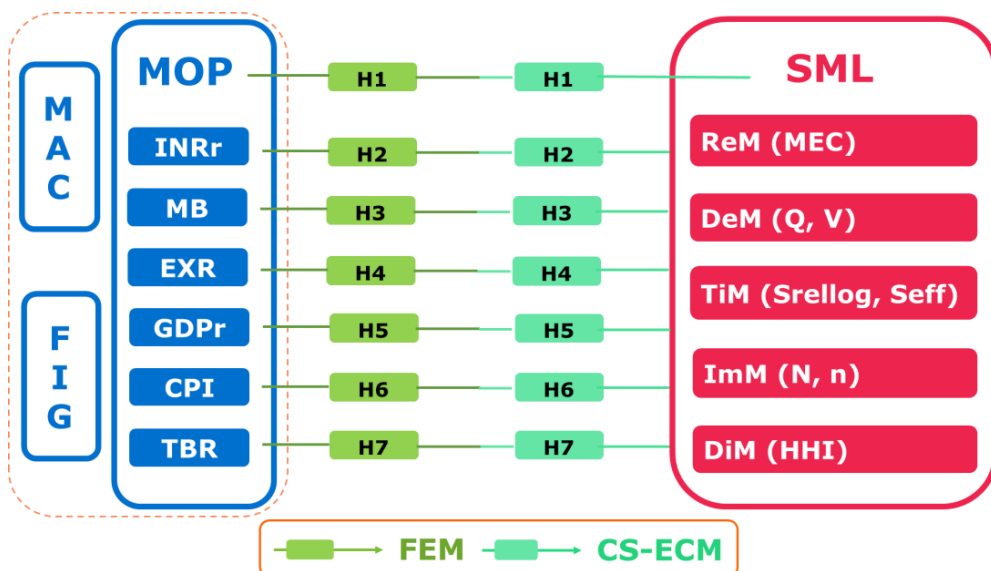

Figure 1.1. Proposed research model approaches

Source: Author's own construction

Note: Hypothesis 1 = H1, Hypothesis 2 = H2, Hypothesis 3 = H3, Hypothesis 4 = H4, Hypothesis 5 = H5, Hypothesis 6 = H6, Hypothesis 7 = H7.

1.8. DISSERTATION STRUCTURE

To address the research questions and objectives, the author conducted six chapters combined to constitute this dissertation. Furthermore, this dissertation applies type B of dissertation structure.

Chapter 1: Introduction

Chapter 1 provides background information concerning the influences between MOP and SML in EMEs. The Chapter highlights the motivation for the research and provides the rationale supporting the research. The research aim is clearly stated, and specific objectives are outlined. Moreover, the Chapter leads the reader to an overview of the research plan and structure.

Chapter 2: Research methodology

Chapter 2 outlines research strategies and techniques employed in the studies and their justification for examining the issues highlighted in the literature review. It presents the description of data collection techniques, provides the framework for data analysis and discusses the limitations of the research.

Chapter 3: Monetary policy and stock market liquidity in emerging market economies: A literature review

Chapter 3 critically reviews relevant literature concerning MOP and SML in EMEs. Published empirical findings and ideas from the literature reviews in similar studies are crucial in shaping and validating this research.

Chapter 4: Modelling impact of monetary policy on stock market liquidity in EMEs during Crisis and Non-crisis periods: A FEM approach

Chapter 4 develops a theoretical model of the association between the MOP's variables and SML in EMEs, especially during Crisis and Non-

crisis periods. The Chapter also examines the proposed model empirically and validates the relationship and impact.

Chapter 5: The causal linkage between monetary policy and stock market liquidity in EMEs: A panel CS-ECM approach

Chapter 5 empirically explores the correlation of MOP on SML in EMEs in the short and long term. Furthermore, the Chapter reveals the causality between MOP and SML variables.

Chapter 6: Discussions and Conclusions

Chapter 6 concludes by disclosing the extent that the research objectives are achieved based on the data collection and analysis. In other words, this Chapter presents an overall dissection and conclusion regarding the several studies building this dissertation and provides new scientific findings and the theoretical and practical implications. Accordingly, these results are considered as recommendations to help rectify the identified problems.

1.9. DEFINITION OF TERMS

1. **MOP**: the money supply by the appropriate monetary authority (i.e. a Central Bank) to achieve specific economic goals.
2. **SML**: investors' ability to buy and sell securities in the stock market with easy transfers.
3. **EMEs**: the economies have been becoming more integrated with global markets as their growth, and have some characteristics of developed markets.
4. **GFC**: refers to extreme stress in the financial system, specifically in global financial markets and banking systems, between mid-2007 and early 2009.

5. **INRr**: the lending interest rate is adjusted for inflation as measured by the GDP deflator. The INRr varies depending on the nominal rate and the rate of inflation.
6. **MB**: the total amount of money created by the Central Bank.
7. **EXR**: the rate at which one currency will be exchanged for another currency.
8. **GDPr**: a monetary measure of the market value of all the final goods and services produced by countries in a specific period. GDPr is often used as an indicator of the economy's general health.
9. **CPI**: a price index of a weighted average market basket of consumer goods and services purchased by households. The annual percentage change in a CPI is used to measure inflation.
10. **TBR**: the Treasury bill's interest rate is a short-term money market instrument.
11. **ReM**: the ability to buy or sell a certain amount of an asset with influence on the quoted price.
12. **DeM**: the ability to buy or sell a certain amount of an asset without influencing the quoted price.
13. **TiM**: the ability to buy and sell an asset at about the same price at the same time.
14. **ImM**: the ability to achieve a transaction immediately at the prevailing price.
15. **DiM**: the market investors' homogeneity follows motivation, size, information and home country or foreign residency.
16. **MAC**: the market value of a publicly-traded company's outstanding shares.
17. **FIG**: an aggregate concept refers to increasing global linkages created through cross-border financial flows.

18. **Financial globalisation:** is an aggregate concept that refers to increasing global linkages created through cross- border financial flows.
19. **Financial integration:** refers to an individual country's linkages to international capital markets.
20. **FEM:** is a statistical model in which the model parameters are fixed or non-random quantities.
21. **FGLS or Feasible GLS:** is a regression technique and uses an estimated variance-covariance matrix since the true matrix is not known directly.
22. **CS-ECM** is known as one of the dynamic models that allow the estimation of short- and long-run relationships with cross-sectional dependence.

CHAPTER 2



CHAPTER 2

RESEARCH METHODOLOGY

OVERVIEW

This research aims to empirically investigate the impact of MOP on SML in the sample of EMEs. A quantitative research methodology conducts the research to address the proposed research questions and hypotheses.

This Chapter is a detailed discussion of the methodology applied to the research. The Chapter is divided into six sections as follows.

- Section 1 provides the research design.
- Section 2 describes the operationalisation of variables.
- Section 3 presents the description of the research area.
- Section 4 defines the population and sampling procedure.
- Section 5 presents the data collection procedure.
- Section 6 explains the data analysis procedure.

2.1. RESEARCH DESIGN

This research utilised a quantitative methodology. A quantitative methodology is suitable for hypotheses testing the relationship between independent and dependent variables (Sekaran & Bougie, 2013). A quantitative methodology has been one of the most popular approaches in finance research during the past seven decades (Dewasiri & Weerakoon Banda, 2016). Baker, Singleton, & Veit (2011) noticed that empirical studies in finance tend to rely on many financial observations, resulting in robust statistical power and analysis of cross-sectional variation. Moreover, the choice of secondary data is appropriate to the research questions and the resources available to the researcher. As a result, the research used secondary data to address the proposed purpose and objectives.

This research was quantitative with an experimental design. The author utilised existing panel data to investigate the relationship between an explanatory variable and an explained variable. This research's experimental design was appropriate due to the historical data used and no intervention involved. The author analysed the data utilising multiple regression models appropriate for panel data analysis to address research aims. Hence, the research design of this research involved the implementation of the multiple regression analysis to expose the association among variables.

2.2. OPERATIONALISATION OF VARIABLES

2.2.1. Explanatory variable

In this research, the author designed one explanatory variable: Monetary policy. Different MOP variables have been utilised to measure MOP's impact in different perceived respects. To investigate the impact of MOP on SML for this research, the author identified several MOP variables that

could capture the overview of MOP's features and influences. They included the real interest rate, money base, exchange rate, real economic growth rate, inflation rate (CPI) and Treasury bill rate.

2.2.2. Explained variable

The explained variable for this research is: Stock market liquidity. There are various approaches to measuring market liquidity in general and SML in specific. Static, dynamic and diversity measures are discovered and used to capture the significant market liquidity characteristics in turn. For this research, the author adopted five different measures to capture all characteristics of SML: Market Resiliency (price-related measure), Market Depth (volume-related measure), Market Tightness (spread-related measure), Market Immediacy (time-related measure) and Market Diversity. One-dimensional liquidity measures were used and assessed by yearly data in this research.

2.2.3. Control variable

Market capitalisation and financial globalisation can significantly influence the MOP-SML nexus. Therefore, the author considered the effect of these market conditions as control variables in the research.

All SML, MOP, and control variables are categorised and described in Table 2.1, in APPENDIX 2.A and in APPENDIX 2.B.

Table 2.1. Categorisation of indicators of SML, MOP and control variables

Variables	Indexes	Measurement*
<i>1. Stock market liquidity</i>		
Resiliency (ReM)	Market-Efficiency Coefficient: MEC	MEC
Depth (DeM)	- Trading volume: Q_t - Turnover: V_t	LnQ LnV
Tightness (TiM)	- Log Relative spread of log prices: LogSrellog_t - Effective spread: Seff_t	LogSrellog LnSeff
Immediacy (ImM)	- Number of transactions per time unit: N_t	LnN Lnn

	- Frequency of transactions: n_t	
Diversity (DiM)	The Herfindahl-Hirschman index: HHI	LnHHI
2. Monetary policy		
Real interest rate	INRr	INRr
Money base	MB	MB
Exchange rate	EXR	LnEXR
Real economic growth rate	GDP _r	GDP_r
Inflation rate	CPI	CPI
Treasury bill rate	TBR	LnTBR
3. Control variables		
Market capitalisation	MAC	LnMAC
Financial globalisation	FIG	FIG

Source: Summarised by the author.

Note: 1. * Data transformation is applied with natural logarithmic form for most of the research variables.

2. “Measurement” of each variable (MOP, SML, MAC and FIG) is used as a name of each variable in this study.

2.3. DESCRIPTION OF THE STUDY AREA

The selected EMEs presently consist of seven countries: China, India, Mexico, Russia, Indonesia, Turkey, and Poland. According to the Morgan Stanley Capital International Emerging Market Index, these developing countries qualify as emerging markets¹. The considered stock markets are shown in Table 2.2 (see APPENDIX 2.C).

On behalf of SSE Partner Exchanges, the SSE provides an overview of the seven selected stock exchanges². The description of these stock exchanges is shown in APPENDIX 2.D.

2.4. POPULATION AND SAMPLING PROCEDURE

Sekaran (2013) referred to the population as the object of study, reflecting people, events, institutions, or any exciting matter in that a researcher wants to generalise the findings. The research took place in the stock

¹ <https://www.thestreet.com/markets/emerging-markets/what-are-emerging-markets-14819803>

² <https://sseinitiative.org/exchanges-filter-search/>

markets located in seven countries of EMEs, namely China, India, Mexico, Russia, Indonesia, Turkey and Poland. The population included all stock markets of the selected EMEs, which provides a corresponding sample for collecting and analysing data. Nevertheless, it is not practically reasonable for the author to address the research problems in the whole population as it consists of a vast number of stock exchanges. Hence, a sample was optioned from the total population to present each country's stock market as representatives. The sampling technique selects a subset of the total population to employ in the study to address the research objectives (Sekaran, 2013; Arikunto, 2010). There are two general sampling methods: probability and non-probability sampling techniques. The research conducted non-probability sampling based on the selective sampling method, which is appropriate for the scope and nature of the research. A selective sample is one in which member selection is relied on meeting specific non-random criteria of the interest to ensure the most relevant information is achieved based on the population (Cooper & Schindler, 2011). According to Sekaran & Bougie (2013), this sampling technique involves choosing population members who are well-equipped with relevant information about the research focus. In this regard, the sample frame for the research, including selected significant stock exchanges of seven EMEs, was targeted to provide a corresponding sample for implementing data collection and analysis.

2.5. DATA COLLECTION PROCEDURE

The author collected panel data (time-series and cross-section data) relating to MOP and SML measures, the data of all seven major stock exchanges in EMEs from 01st Jan 2000 to 31st Dec 2018. For variables measuring SML, data were collected from Bloomberg and stock exchange websites. The considered stock scope included all stocks traded at the

selected significant stock exchanges. In the analysis, the author only included a stock being suggested standards, such as more than 100 trading days per year, at least 15 observations, etc., to eliminate outliers and erroneous data. The author collected the daily high price, low price, opening price, closing price and trading volume for the selected stocks to determine daily returns, volatility and liquidity proxies. Then, the daily figures were averaged to build yearly figures because most of the macroeconomic variables concerning MOP estimates are available yearly. For all macroeconomic variables concerning the conduct of MOP of seven selected EMEs, data were from Bloomberg and the World Development Indicators database of the World Bank.

2.6. DATA ANALYSIS PROCEDURE

Data analysis was employed to address the research questions, objectives and hypotheses. Data analysis was conducted using STATA 15, a general-purpose statistical software package developed by StataCorp.

2.6.1. Variable calculation

Before performing data analysis, the data preparation was completed by calculating, entering and cleaning the data. All variables were collected and computed in the empirical models according to the measure formula of each variable.

2.6.2. Data transformation

Data transformation was applied with the natural logarithmic form for most research variables to gain more constant variance and normalise the probable presence of non-linearity in the data. Natural logarithm transformations were done to base “e”.

2.6.3. Descriptive statistics

Descriptive statistics summarise statistical criteria to provide information for the initial generalisation of all variables in the empirical models. This descriptive analysis included several things, namely frequency distribution, measures of central tendency, and measures of variability.

2.6.4. Classic assumption tests

Before performing data analysis, the author examined the data properties relating to classical assumptions to ensure that the regression models satisfy OLS estimators' assumptions. Thus, in order to test the classic assumption deviation, several tests were used as follows:

- Linearity:

The linearity assumption can be tested through the visual examination of residual plots. The author used the Augmented component-plus-residual plot versus independent variables to suggest linear relationships in this research.

- Unusual and influential data:

A simple way to detect unusual and influential data is to plot the residuals and the squared residuals from the estimated regression model. The added-variable plots were graphed to find outliers in each SML variable model.

- Normality of residuals:

Likewise, for tests for linearity and outliers, graphical methods can be conducted to visually inspect the normal distribution of a data set prior to further interpretation of the regression analysis. Hence, the author applied the standardised residuals' P-P plot (probability-probability plot). The normal distribution was depicted in a P-P plot by a random scatter of plots around a 45-degree line.

- Correlation:

Pearson r correlation was implemented to measure the degree of the relationship between linearly related variables. Equation (2.1) was used to calculate the Pearson r correlation:

$$r_{xy} = \frac{n \cdot \sum x_i \cdot y_i - \sum x_i \cdot \sum y_i}{\sqrt{n \cdot \sum x_i^2 - (\sum x_i)^2} \cdot \sqrt{n \cdot \sum y_i^2 - (\sum y_i)^2}} \quad (2.1)$$

r_{xy} : Pearson r correlation coefficient between x and y.

n: number of observation

x_i : the value of x (for ith observation)

y_i : the value of y (for ith observation)

- Multicollinearity:

The author conducted the multicollinearity test by VIF for the independent variables calculated in the regression models. According to Gujarati et al. (2012), if $VIF < 5$, there is no multicollinearity phenomenon; however, if $VIF > 10$, the model is concluded to have multicollinearity.

- Model specification:

Model specification errors can considerably influence the estimation of regression coefficients. The author utilised a link test for model specification. In order to make a firm conclusion about the model specification, the author also performed another test of regression model specification. It performed RESET for omitted variables. The Ramsey RESET tests used powers of the fitted values of each SML variable with the null hypothesis “Model has no omitted variables”.

2.6.5. Model specification

The author specified different research models employed based on the proposed research questions, objectives, and hypotheses, such as FEM and CS-ECM.

2.6.6. Regression diagnostics concerning the characteristics of the selected panel data models

Generally, several tests were conducted to ensure regression diagnostics of the selected panel data model. However, depending on the proposed research questions, objectives and hypotheses, more specific tests could be utilised in each type of the selected research model.

2.6.7. Estimation of the selected research model

The estimation of each research model was implemented following the identified model specification.

CHAPTER 3



CHAPTER 3

MONETARY POLICY AND STOCK MARKET LIQUIDITY IN EMERGING MARKET ECONOMIES: A LITERATURE REVIEW

ABSTRACT

In the era of globalisation, the financial systems of all countries have faced severe challenges and their negative impacts, such as an overheated economy, high inflation, stock market crash, financial crisis, and other financial collapses. It has raised significant concerns influencing the effects of macroeconomic policies and responses of the financial system of each country all over the world, even in normal times and turbulent times in various respects. And stock markets in EMEs are no exceptions. Indeed, it is proven by more and more studies that have been implemented to assess SML in EMEs in different periods and the impacts of certain macroeconomic drivers on MOP. This study aimed to systematically review the literature on MOP and SML measures and how MOP affects SML. The study summarised the essential findings and approaches in the extant literature. Numerous reputable academic databases were used via a systematic methodology of literature review. Generally, this study shed light on the crucial macroeconomic role of MOP as a potential determinant of SML in different timelines. Recommendations and theoretical discussions given by researchers provided an overall review of the relationship between MOP and SML in EMEs.

3.1. INTRODUCTION

The lack of liquidity in markets directly impacts the whole financial system and indirectly impacts the whole economy, impeding their usual and operational way of functioning. As a “prism” to observe economic developments, the stock market is one of the most vital areas of an economy. Accordingly, SML is of prime importance even to the economy and can be considered as an indicator of investment sentiment and a direction of money flow. Ellington (2018) stated that lower liquidity levels adversely hold economic growth back during a period of crisis. In line with a supportive view, studies of Næs et al. (2011) and Smimou (2014) defined SML as a relevant parameter in forecasting the future state of the economy. Meanwhile, a country’s macroeconomic environment is influenced by its MOP, which impacts the financial markets (Gust & López-Salido, 2014). Furthermore, the severe challenges that all countries’ financial systems have faced in the era of globalisation and one of the severe consequences, namely the GFC of 2007-2009, have indicated the outstanding importance of the liquidity of financial system in general and SML in particular. More specifically, aligning with the growing importance of market-oriented economies and economic alliance with developed markets, enhancing SML in EMEs has become more significant in attracting high capital inflow from the rest of the world, provide “an efficient and viable alternative to bank financing” and help boost and sustain growth.

As a result, it drove questions of the insight correlation between macroeconomic policies and SML to the limelight. This is proven by more and more studies implemented to assess SML in EMEs in different periods and which macroeconomic drivers affect it. A great number of theoretical and empirical researchers have continuously addressed

liquidity issues via its macroeconomic and microeconomic drivers. Thereby, the relationship between MOP and SML has become one of the hot topics in financial research, as many economists consider MOP the most important macroeconomic policy (Maskay, 2007). As such, how MOP influences the SML in EMEs has been of vital interest to policymakers, investors and scholars during normal times and even more so during times of crisis.

The primary aim of this study is to systematically disclose the distinct influences of MOP on SML in EMEs. Based on theoretical and empirical studies, this research classifies and organises the literature and provides an important review of the relationship between macroeconomic management policies (MOP in specific) and SML from different perspectives.

With the above brief overview of the importance of SML and the crucial macroeconomic role of MOP in the field of financial research, the study has had an extensive review of the literature with a significant focus on the concept of MOP and liquidity measurement, transmission mechanisms of MOP and the stock market, factors impacting SML and the relationship between MOP and SML in EMEs in different timelines.

3.2. MONETARY POLICY MEASURES AND TRANSMISSION MECHANISM OF MONETARY POLICY AND STOCK MARKET

3.2.1. Monetary policy measures

Conducting MOP is crucial for Central Banks or a country's monetary authority (i.e. a Central Bank) to achieve price stability (low and stable inflation) and control economic fluctuations. MOP is defined as monetary measures conducted by a Central Bank to impact economic activities,

price stability, employment and stability of the long-term interest rates (Okpara, 2010). There are two common types of MOP, comprising contractionary MOP called a tight MOP and expansionary MOP called an easy MOP (Mishkin, 2013). The contractionary MOP is applied when inflation is a problem and the economy needs to slow down by curtailing the money supply. In contrast, expansionary MOP is employed when the economy is in recession and unemployment is a big problem.

MOP responses have their most direct and immediate impacts on the larger financial markets: government and corporate bond markets, mortgage markets, markets for consumer credit, foreign exchange markets, stock markets, and many others. MOP influences financial markets (stock market in particular) and economic activity differently.

Many studies have assessed the connection between financial markets (especially the stock market) and MOP under the different circumstances of domestic and international monetary policies. To estimate their correlation, these have used various MOP variables as indicators of MOP's impact. More specifically, from different perspectives, different researchers have investigated the relationship between MOP and SML in different quantity and quality of MOP measures, relating to influential features of MOP. For instance, only one MOP measure (Chu, 2015; Herwany et al., 2017; Marozva, 2020); three MOP measures (Kingsley et al., 2020); four measures (Octavio et al., 2013; Debata & Mahakud, 2018; Igbinsosa & Uahunmwangho, 2019); six MOP measures (Goyenko & Ukhov, 2009); and so forth. It is noted that it is the same quantity of MOP measures, but different quality features are considered in different studies.

Researchers have commonly employed several MOP measures as standard indicators that could capture the results of MOP's influence, such as the

interest rate, monetary aggregates, exchange rate, economic growth rate, inflation rate (CPI) and the Treasury bill rate.

3.2.2. Transmission mechanism of monetary policy and stock market

MOP transmission is a process in which MOP changes are expected to affect aggregate demand, output and price level in the economy (Meltzer, 1995), and the stock market is no exception. There are at least six main subchannels in three channels relating to MOP transmission to economic activities (especially a stock market) (Mishkin, 2013). (See Figure 3.1 in APPENDIX 3.A)

Interest rate channel:

The traditional view reflects a decrease in nominal interest rate (i); a fall in real interest rate would cause a rise in investment spending (I), increasing aggregate demand and a rise in output (Y). The critical point is that a fall in the actual cost of borrowing would promote investment.

$$M \uparrow \Rightarrow i \downarrow \Rightarrow I \uparrow \Rightarrow Y \uparrow$$

Interest rates are a type of asset price and are considered the primary transmission channel in Keynesian conception.

Exchange rate channel:

MOP impacts the exchange rate via interest rates. An expansionary MOP would increase the money supply, causing a reduction in interest rates. Under conditions of perfect capital mobility and substitutability of financial assets, capital would flow out, and domestic currency would depreciate (E). Accordingly, depreciation would make the country's exports more attractive to foreigners; an increase in net exports (NX) would result in greater aggregate demand leading to a rise in output (Mishkin, 2006).

$$M \uparrow \Rightarrow i \downarrow \Rightarrow E \uparrow \Rightarrow NX \uparrow \Rightarrow Y \uparrow$$

Tobin's q theory channel:

Tobin index = Q = market value of the company/replacement cost

If $Q > 1$ and high, the stock's market value is higher than the replacement cost of the company's assets. If the index $Q < 1$ and low, the new investment demand will decrease. As a Central Bank expands its money supply M , Stock prices (P_s) tend to increase, increasing Q and demand for new investments:

$$M \uparrow \Rightarrow P_s \uparrow \Rightarrow Q \uparrow \Rightarrow I \uparrow \Rightarrow Y \uparrow$$

Bank lending channel:

An increase in money supply via a rise in bank reserves would raise the banks' ability to enlarge lending. Banks would provide available loans to new borrowers dependent on bank loans. This will encourage more consumer spending in purchasing semi-durables and business investments. When investment increases, it will stimulate investment demand in the stock market.

$$M \uparrow \Rightarrow \text{Bank reserves} \uparrow \Rightarrow \text{Bank deposits} \uparrow \Rightarrow \text{Bank loans} \uparrow \Rightarrow I \uparrow \Rightarrow Y \uparrow$$

Balance sheet channel:

The balance sheet channel emphasises collateral's role in decreasing moral hazards. An expansionary MOP causes rises in financial and physical asset prices, raising the market net worth of companies and the value of collateral, company cash flow and ultimately the company's creditworthiness. Moreover, an increase in asset prices raises the ratio of liquid financial assets to household debt, thus lowering the probability of financial distress and increasing consumption and housing investment (Mishkin, 2001).

$$M \uparrow \Rightarrow i \downarrow \Rightarrow P_s \uparrow \Rightarrow \text{Firms' net worth} \uparrow \Rightarrow \text{Adverse selection} \downarrow,$$

$$\text{Moral hazard} \downarrow \Rightarrow \text{Lending} \uparrow \Rightarrow I \uparrow \Rightarrow Y \uparrow$$

Cash flow (Money supply) channel:

The money supply channel viewpoint is that an expansionary MOP increases bank reserves and releases the constraints on banks' ability to create more loans, and as a result, the short-term interest rate falls (e.g. King, 1986; Ramey, 1993; Romer et al., 1990; Thornton, 1994).

Basically, the interest rate channel is part of the monetary transmission mechanism that together with the monetarisation feature of the money supply, is called the money view. Because of its axiom, an increase in outside money reduces the real interest rate. This increases business investment because many profitable projects are available at higher required rates of return. A policy-induced change in the policy interest rate(s) directly influences money-market interest rates and indirectly lending, deposit rates and stock prices. The interest rate channel is the traditional mechanism and is often considered as the main component of MOP transmission (Taylor, 1995; Loayza & Schmidt-Hebbel, 2002). It lies at the heart of the monetary transmission mechanism theory and the traditional Keynesian textbook IS-LM model, developed by Hicks in 1937.

3.3. STOCK MARKET LIQUIDITY MEASURES AND FACTORS IMPACTING STOCK MARKET LIQUIDITY

3.3.1. Stock market liquidity measures

Liquidity has become a topic of many investigations in the financial literature for many years, especially SML. More importantly, SML is primarily essential to the national economy and is regarded as a relevant parameter in forecasting the future state of the economy (Næs et al., 2011; Smimou, 2014). Nevertheless, O'Hara (2004) stated that "liquidity is hard to define but easy to feel it". An early definition of liquidity can be found in Keynes (1930), and it has been identified from different angles in

research (e.g. Shen & Starr, 2002; Amihud et al., 2005; Brennan et al., 2012). SML is an essential market characteristic whose presence enhances the well functioning of the market and vice versa. In the stock exchanges, SML reflects the investors' ability to buy and sell securities in the stock market with easy transfers.

Liquidity is a large concept covering multiple dimensions. In general, there are mainly four dimensions in market liquidity, including Depth, Width /or Tightness, Immediacy, and Resiliency. Market depth essentially demonstrates the level of supply and demand of the securities traded in a financial market. Market tightness is defined as a minimum conversion cost. Market immediacy indicates the speed of transactions of a given size at a given time. Market resiliency is defined as the ability of the market to restore a reasonable market price during a flow of newly generated orders. However, depending on the liquidity proxies used, the relationships are not consistently correlated, suggesting that liquidity is an elusive multidimensional concept (Stoll, 2000; Chai et al., 2010). Due to its multidimensional nature, many measures have been employed to assess overall market liquidity. First and most notably, Kyle (1985) referred to an asset's static dimensions (tightness and depth) and resilience. Harris (1990) completed the dynamic dimensions with immediacy. Following Kyle (1985) and Harris (1990), Baker (1996) conceded that market liquidity is a function of three characteristics of a liquid market, namely depth, breadth, and resiliency. Moreover, Baker (1996) concurred that immediacy reflects the processing of the order and the speed of settlement, and tightness implies low transaction costs. More specifically, the measurements of the "depth" and "breadth" dimensions have been enormously utilised compared to the other dimensions. The "tightness" dimension has been concerned with adequately assessing liquidity

measurement, while the “immediacy” dimension is implicit. Additionally, the “resiliency” dimension has been employed by several studies. Lastly, the “diversity” dimension was disclosed by Kutas & Véghe (2005) and Váradi (2012). It is not easy to measure and capture all aspects of liquidity in a single measure due to its multidimensional characteristics; hence, there are different liquidity measures. (Wyss, 2004). The results from multiple measures of liquidity can point to various conclusions (Benić & Franić, 2008).

Furthermore, liquidity measures are divided into one-dimensional and multidimensional ones (Wyss, 2004). These measures were evaluated based either on intraday (high-frequency) data or daily, weekly, monthly, quarterly and yearly (low-frequency) data. Although measures based on high-frequency data have mostly been employed in reality, they offer more accurate estimations of liquidity proxies. Hasbrouck (2009) and Goyenko et al. (2009) evidenced that low-frequency measures can be fairly used over high-frequency ones to measure liquidity. Some liquidity measures have been benchmarked using high-frequency and order-driven developed countries’ stock markets. However, low-frequency measures can be evaluated against benchmarked measures in EMEs. (See Figure 3.2 in APPENDIX 3.B)

3.3.2. Factors impacting stock market liquidity

Numerous research in market liquidity provides analyses of the different factors posing a threat to market liquidity or enhancing market liquidity. In general, although liquidity and its components have crucial importance in the healthy functioning of the financial markets, its measurement remains complex and not complete. Hence, it is not surprising to assume that the microeconomic factors are not the only liquidity determinants but

also macroeconomic factors (primarily MOP) that may influence the liquidity quantity and quality in the market.

For microeconomic factors, there are some common factors determining market liquidity. Market volatility has been defined as a significant determinant of stock liquidity. Besides, trading activity by various investor types is determining factor, especially institutional investors. Moreover, foreign investors' sentiments have a positive effect on market liquidity or a negative effect on market liquidity. Additionally, the impacts of stock exchange mergers and developments in the trading systems have been considered as prominent factors of SML. Some studies have also presented evidence that the relevance of corporate governance determines SML. Furthermore, company-specific factors have been identified as a significant impact on stock liquidity. (See Figure 3.3 in APPENDIX 3.B)

For macroeconomic factors, studies have found that macroeconomic policy announcements significantly impact liquidity, including fiscal policy and MOP. Many economists consider MOP as the most critical macroeconomic policy (Maskay, 2007). More and more research has conceded the influential role of MOP on SML in various contexts. Octavio et al. (2013) indicated that an expansionary MOP announcement positively affects the SML of small-sized stocks. Busch & Lehnert (2014) revealed that expansionary MOP measures and the imposition of short-selling bans in the stock market improve stock liquidity. Regarding the EMEs, Syamala et al. (2017) explored that the Indian SML is strongly affected by the policies regulated and announced by its government and financial institutions. By contrast, Sensoy (2016) and Ekinci et al. (2019) conceded that EME is extremely sensitive to the macroeconomic announcements made by developed countries, particularly announcements

concerning MOP. In terms of macroeconomic policies, Chowdhury et al. (2018) disclosed that MOP mainly determines market liquidity across different stock market sectors along with fiscal policy. (See Figure 3.4 in APPENDIX 3.C)

3.4. EMERGING MARKET ECONOMIES

EMEs and their alternatives, such as “emerging markets or emerging economies or emerging economy countries”, have become familiar concepts for businesses, policymakers and academic researchers in recent decades, even though no official definition of an emerging market exists. EMEs have enormously contributed to the global economy via the critical role of being the primary driver of global growth, particularly GDP growth and consumption.

During the changing of the world economy, the term “emerging markets” is increasingly common in the news and reports. This term was coined by World Bank economist Antoine van Agtmael in 1981 when he worked for the International Finance Corporation (IFC), a division of the World Bank. Mr Agtmael spent the weekend dreaming up the term “emerging markets” with the hope of evocation in “progress, uplift and dynamism”³. It is obvious that the label has proven wildly successful. Figuratively speaking, the World Bank created “emerging markets”, dramatically influencing the global business world (Gwynne et al., 2003). Emerging markets are countries whose economies are increasing fast and are in a transition phase to a market economy (Simon, 1997).

3

https://www.ifc.org/wps/wcm/connect/corp_ext_content/ifc_external_corporate_site/about+ifc_new/ifc+history/establishing-emerging-markets.

Generally, an emerging economy can be identified by some significant characteristics (Mody, 2004). An emerging market economy has low to middle per capita income. It is a nation whose economy mimics a developed nation but does not fully meet the classified requirements. Besides, they have rapid growth, meaning a high economy's growth rate. From 1980 to the present, although there has been a significant fluctuation in the economic growth of the EMEs and developing economies, their real GDP growth rate is always higher than in advanced economies (see Figure 3.5 in APPENDIX 3.D). Furthermore, their third characteristic is high volatility. It can be caused by three factors: natural disasters, external price shocks, and domestic policy instability. The growth of these economies requires a lot of investment capital. Nevertheless, capital markets are less mature in emerging economies than what is seen in developed markets. It is the fourth characteristic: currency swings. They do not have a good achievement of foreign direct investment. It is usually hard to get complete information about listed companies on their stock markets. Selling debt (e.g. corporate bonds) may not be easy on the secondary market. All these components increase the risk. It also means that investors willing to do ground-level research can get a greater reward⁴. If it is successful, the rapid growth can also lead to the investors' fifth characteristic, higher-than-average return. It is because many of these countries somewhat concentrate on an export-driven strategy. The companies pursuing this strategy will profit, boosting higher stock prices for investors. A higher stock price and a higher return on bonds cost more to cover the additional risk of emerging

⁴ <http://www.nasdaq.com/article/what-is-the-difference-between-a-developed-emerging-and-frontier-market-cm140649>

market companies⁵. This quality makes EMEs attractive to investors. Not all EMEs are set up to become breakout nations; thus, suitable investments. They must also have little debt, a growing labour market, and a not corrupt government. In addition, the most powerful EMEs are like through a series of characteristics such as massive natural reserves as both volume and diversity, competitiveness is more visible in the industrial sector, and agricultural and consumer markets are robust (Sechel et al., 2014).

3.5. DISCUSSION ON THE RELATIONSHIP OF MONETARY POLICY AND STOCK MARKET LIQUIDITY IN EMERGING MARKET ECONOMIES

Regulators and policymakers have recognised that the stock market plays an essential role in transmitting the effects of MOP on actual economic activities. Changes in MOP implementation made by a Central Bank of each country can significantly influence financial markets. If the Central Bank adopts a counter-cyclical MOP, it will result in a negative relation between inflation and stock returns, while if it adopts a pro-cyclical MOP, a positive relationship will be observed (Sellin, 2001). The relation between the stock market and MOP has been explained through asset pricing theory. As a result, extensive literature on MOP (including mainly MOP shocks, MOP adjustments, MOP announcement, the transmission mechanism of MOP) and stock market (such as stock price, stock index, stock returns, stock market performance, stock market volatility, etc.) has been explored and conceded time by time (see Figure 3.5 in APPENDIX 3.D). MOP can influence the stock market via

⁵<http://citeseerx.ist.psu.edu/viewdoc/download?doi=10.1.1.385.6473&rep=rep1&type=pdf>

different channels, such as the interest rate channel, the credit channel, the asset price channel, the exchange rate channel and the expectations channel (ECB, 2010).

Likewise, in related studies in developed and developing countries, mixed evidence of the impact of MOP on liquidity has been gathered in EMEs from the theoretical and empirical literature. More specifically, MOP variables may positively or negatively influence the SML in the short and long run, or during crisis periods; or no relationship between these two variables exists; or a causal relationship between them exists.

Many studies of the MOP-SML nexus tend to focus on a specific single market of EMEs (like China, India) to evaluate the precise impact of MOP on SML. Besides the single market, areas (like the Asian-Pacific Region, Latin American Markets, Southeast Asian stock markets and ASEAN-5 countries) or groups of some correlated economies (like BRICS) are commonly selected to investigate the potential correlation between MOP and SML.

Moreover, a majority of studies examining the relationship between MOP and SML have been conducted with a focus on advanced economies (e.g. Fujimoto & Watanabe, 2004; Bredin et al., 2007; Gregoriou et al., 2009; Jain et al., 2011; Ciccarelli et al., 2013; Jannsen et al., 2019; and others).

In addition, most of the research has no significant timeline separation for crisis periods, for instance, between the Global Financial Crisis period and the Normal period (e.g., Celebi & Hönig, 2019; Marozva, 2020).

Numerous authors have studied the linkage between MOP and liquidity in the stock market via different econometric models. Methodologically, with the data sample selection, most existing studies have investigated the connection between MOP and SML in developed, developing and EMEs, focusing entirely on time-series analysis. Especially some typical models

preferred to apply are VAR, OLS, or VECM. (See Figure 3.6 in APPENDIX 3.D)

3.6. CONCLUSION

The current study has summarised literature on liquidity in stock markets of EMEs and the macroeconomic management of MOP using a systematic literature review methodology.

Firstly, this study gives a deeper understanding of liquidity and MOP by reviewing the existing theoretical and empirical research on the topic. Many researchers have created multiplicities of proxies (measures) on SML to summarise different characteristics and dimensions of liquidity. These measures have evaluated liquidity at various levels in various markets. On MOP, many measures with different angles have been applied to give an overview of MOP's impact and the Central Bank's role.

Secondly, different MOP implementations affect the stock market in general and SML in specific. Based on applying various methods, most scholars demonstrate that the relationship between MOP and SML variables is asymmetric, and MOP can have asymmetric effects for several reasons. Besides, empirical results showed that the nature of the relationship is subject to liquidity measures used and tends to depend on the data sample of analysis.

Thirdly, in an attempt to analyse the relationship of MOP and the stock market with a lack of timeline separation between the Crisis period and the Non-crisis period, although the MOP effect varies among different countries, many researchers have similar result on impact level.

From an overall perspective, the noticeable findings given by researchers provide a panorama of the relation between MOP and SML in EMEs. Thus, a systematic literature review identifies directions and broadens future research.

CHAPTER 4



CHAPTER 4

MODELLING IMPACT OF MONETARY POLICY ON STOCK MARKET LIQUIDITY IN EMEs DURING CRISIS AND NON-CRISIS PERIODS: A FEM APPROACH

ABSTRACT

According to theoretical and empirical evidence, “the ups and downs of the stock market” are influenced by macroeconomic policies in general and MOP in particular, in normal and turbulent times, with different perspectives. To fully understand how a MOP impacts SML in EMEs, the study evaluated their association in seven selected countries of EMEs during the Global Financial Crisis and Non-crisis periods by utilising panel data techniques with yearly data for the period 2000-2018. The findings explored the relationship between MOP and SML differently from other related studies by capturing an overall influence of MOP on each major characteristic of SML.

Understanding the MOP-SML nexus is crucial from the view of researchers, policymakers, and investors in this changing global environment.

4.1. INTRODUCTION

Although “the stock market is not the economy”, “the ups and downs of the stock market” are affected by macroeconomic policies in general and MOP in particular in normal times and turbulent times in various respects. MOP changes made by each country’s Central Bank can significantly influence the financial markets (Sellin, 2001). More specifically, in EMEs, the terms “monetary policy” and “stock market liquidity” are the first attention of researchers, regulators, policymakers, and the investment community. EMEs have been taking a more significant force and role in the global economy and have become inextricable in the era of globalisation. Interestingly, different empirical studies have contended that the association between MOP and SML is complex and overwhelming in EMEs concentrated on a specific single market, certain areas, or correlated economies. Various authors have presented mixed evidence relating to the theoretical and empirical relations of MOP and market liquidity through different perspectives by using some standard measures of SML and MOP concerning their characteristics (e.g. Yong et al., 2013; Chowdhury et al., 2018; Marozva, 2020; Debata et al., 2021; Babangida & Khan, 2021; and others). Methodologically, most existing studies focus on time-series analysis, especially with VAR, OLS, VECM, GARCH or ARIMA.

Despite this, to the author’s knowledge, several drawbacks still exist to be considered address: Firstly, most studies have only discovered the connection between MOP and SML (especially the impact of MOP on SML) through some MOP indicators and SML characteristics, even though it is evaluated at the macro (overall market) and micro (individual stocks) levels. Secondly, most scholars have assessed the MOP-SML nexus in developed, developing and emerging countries, focusing on a

specific country or some countries, not considering benchmark similarities in MOP and SML variables to select an appropriate research country sample. Thirdly, few studies have generally investigated the linkage between MOP and SML in the group of EMEs during the Crisis and Non-crisis periods. Fourthly, limited studies have examined the correlation between MOP and SML using panel data analysis from a wide cross-section of countries over a long period.

This study is expected to enrich the extant body of knowledge regarding the relationship between MOP and the stock market by looking at the issue from various angles. The big picture of the impact of MOP on SML is shown by fully capturing the influential properties of MOP and the major characteristics of SML. The study presents evidence that the association of MOP and SML is explored in EMEs, considering similarities in MOP targeting and sustainable stock market objectives. The answer to whether and how MOP influences SML in EMEs in the Crisis and Non-crisis time is revealed through employing a static panel model approach, namely the FEM. The study is carried out to address the unfilled gaps systematically. It would be a rational premise for the insightful overview and the predictability of SML in EMEs during the Crisis and Non-crisis periods via MOP role in the future.

The study is structured as follows. Section 4.2 reviews related literature on the association between MOP and SML. Section 4.3 describes the data set, the applied variables, including the measures of MOP and SML, and the research model. Section 4.4 details the methodology employed, indicating data variables, assumption tests and empirical models. Section 4.5 discusses the empirical results for related assumption tests, model regressions and finding explanations. Section 4.6 summarises the results, draws the main conclusions and highlights future research perspectives.

4.2. RELATED LITERATURE REVIEW

4.2.1. Monetary policy and stock market liquidity in emerging market economies during Crisis and Non-crisis times

In line with research conducted in advanced economies, answers to how the impact of MOP on the stock market (especially SML) in EMEs have increasingly been disclosed by researchers' different perspectives and empirical analyses. In both particular country studies and multi-country studies, macroeconomic variables concerning MOP may influence positively or negatively SML in the short and long run (e.g. Chinzara (2010) in South Africa; Hosseini et al. (2011) in China and India; Abu et al. (2012) in Malaysia; Santos et al. (2013) in Brazil; Mohapatra & Rath (2015) in India, Brazil, and China; Tripathi & Kumar (2016) in BRICS; El Abed (2017) in two Mexico and Brazil), or no relationship between these two variables exists (e.g. Pethe & Karnik (2000) in India; Zakaria & Shamsuddin (2012) in Malaysia; Tripathi & Kumar (2015) in BRICS), or a causal relationship presents (e.g. Srinivasan (2011) in India; Zakaria & Shamsuddin (2012) in Malaysia; Tripathi & Kumar (2015) in BRICS; Mohapatra & Rath (2015) in India, Brazil, and China). (See Figure 4.1 in APPENDIX 4.A)

Reality shows that there were notable different opinions on the impact of MOP on the SML during Crisis and Non-crisis periods. Indeed, the Global Financial Crisis negatively influenced market liquidity and significantly raised market illiquidity. Concerning this problem, numerous empirical studies indicate that MOP matters for SML and how the role of MOP in SML in the crisis period. It is clear from the evidence that the predictive power of MOP for SML exists, especially during crisis periods (e.g.

Fujimoto & Watanabe, 2004; Chordia et al., 2005; Marozva, 2020). More specifically, liquidity depends on MOP adjustments (e.g. Debata & Mahakud, 2018; Celebi & Hönig, 2019; Jannsen et al., 2019). How financial crises have influenced the transmission mechanism of the country's MOP. Ciccarelli et al. (2013) figured out that the transmission mechanism of MOP changes with the Crisis, with a strong amplification effect of the credit channel in countries under sovereign stress. To be more specific, MOP became more effective at stimulating economic activity during the Global Financial Crisis. One notable similarity in all those studies is that they have examined market liquidity using mainly developed stock markets (such as the USA, the UK, etc.). As a result of the difference between developed and emerging markets, outcomes from developed markets may not be reasonably concluded for emerging markets. Although all authors investigate the effect of MOP on SML in different countries using various methods, many studies have reported that market liquidity dropped significantly during the Crisis, even in developed stock markets. Accordingly, MOP is a significant impact and plays a central role in determining SML. (See Figure 4.1 in APPENDIX 4.A)

Before the Global Financial Crisis of 2007-2009, MOP in many countries (especially in developed countries) altered the short-run nominal interest rate to maintain price stability, sustain full employment or achieve both. Considering the science of MOP, Mishkin (2010) described the MOP strategy before the Crisis, including flexible inflation targeting; certainty equivalence, gradualism and risk management; the dichotomy between MOP and financial stability policy; the response of MOP to asset price bubbles: the “Lean” versus “Clean” debate. The consensus before the Crisis was that Central Banks should focus on stabilising inflation and the output

gap, and ignore fluctuations in asset prices, even if the latter is realised to be driven by bubbles (e.g. Bernanke & Gertle, 1999; Kohn, 2009).

After the Crisis, MOP will never be the same (Blanchard, 2013). The Global Financial Crisis has been challenging for policymakers worldwide, especially for Central Banks. Conducting surveys of Central Bank heads and academic economists across four themes, Blinder et al. (2017) reported that the way Central Banks conduct MOP was changed in several dimensions by the Crisis. Concerning the causes of MOP reactions, Blinder et al. (2017) concluded: “due to the severity of the Crisis and the need for Central Banks to act quickly, there was often little time to consider the pros and cons of the various measures”. Accordingly, MOP effects on the stock market in general and SML in specific have been at different levels in macroeconomic management in every country. However, most studies reported ineffective impacts of MOP on SML after the Crisis. More specific evidence, by evaluating the effectiveness of MOP during downturns related to financial crises in the sample of 24 developed countries in the mid-1960s, Bech et al. (2014) disclosed that MOP is not very effective in stimulating GDP growth during the recovery phase of a financial crisis. (See Figure 4.1 in APPENDIX 4.A)

H1: There exists a significant impact of monetary policy on stock market liquidity in emerging economies in Crisis and Non-crisis times.

4.2.2. Interest rate and stock market liquidity

The interest rate is known as one of the most specific tools in the MOP utilised by major Central Banks in the liquidity supervision of different countries. Making interest rate modifications is crucial in enhancing SML (e.g. Sprinkel, 1964; Homa & Jaffee, 1971; Keister, 2019; Herrenbrueck, 2019). First and foremost, interest rates represent the rate at which investors discount risk-free and risky future cash flows. In addition, being together

with other assets' prices, they transmit valuable information about the economic outlook (e.g. Harvey, 1988; Mishkin, 1990; Estrella & Mishkin, 1998; Ang et al., 2006). Theoretical and empirical literature indicates an uncertain relation between interest rates (e.g. short-term interest rate, long-term interest rate, real interest rate, lending rate) and SML (e.g. stock prices, stock returns, stock index). As the traditional view and most studies documented, a significant negative relationship exists between interest rates and SML. It means interest rate cuts lead to higher capital flows to the stock market, stock price rise and expected higher rates of return and vice versa. Many researchers stated this in the US, other advanced economies and EMEs. By contrast, several studies with conflicting findings indicated a positive relationship between the interest rate and SML in some special periods (such as during financial crises). Besides the findings of the developed countries, the outcomes of the emerging countries presumed the positive nexus of the interest rate and SML. Although the negative and positive associations between interest rates and SML are validated in the theoretical and practical literature, some studies disclosed that interest rates do not significantly impact the stock market (e.g. Omodero & Mlanga, 2019). (See Figure 4.2 in APPENDIX 4.A)

H2: Interest rate has a significant negative/positive impact on stock market liquidity in EMEs.

4.2.3. Monetary aggregates and stock market liquidity

The literature has created a mixed picture of the relationship between monetary aggregates and SML (e.g. stock prices, stock returns, stock index). Central Banks compiled monetary aggregates based on surveys of monetary and financial institutions and measured the amount of money

circulating (called the money supply) in an economy⁶. In terms of the money supply-stock price nexus, real activity theorists debate that changes in the money supply and stock prices have a positive association, whereas Keynesian economists debate otherwise (Sellin, 2001). A positive money supply-stock prices nexus has been documented in most studies for major developed countries in the short term, especially in the U.S. The research conducted in EMEs also supports the last evidence of the positive correlation between money supply and stock prices in the short term. Nevertheless, the short-run negative correlation between the money supply and stock price switches its sign and tends to be a positive significance in the long run (e.g. Suhaibu et al., 2017; Chowdhury et al., 2018; Debata & Mahakud, 2018). Unlike the studies that stated the positive nexus of money supply and stock prices, some scholars argued that money supply negatively affects stock prices (especially in unanticipated changes in money) in developed, developing and emerging countries. Considering the money supply-stock return nexus, like the evidence provided in the U.S and other developed countries, a positive association between money supply and stock returns was detected in EMEs. However, some studies concluded a negative relationship between money growth and subsequent stock returns in advanced economies. It is noteworthy that some authors detected a weak relation or no linkage between money supply and stock price/or stock return in developed, developing and emerging economies. (See Figure 4.2 in APPENDIX 4.A)

H3: Monetary aggregates have a significant positive/negative impact on stock market liquidity in EMEs.

⁶ <https://stats.oecd.org/glossary/detail.asp?ID=1672>

4.2.4. Exchange rate and stock market liquidity

The exchange rate is regarded as a crucial monetary indicator because exchange rate fluctuations may affect financial policy via its impacts on the national stock market (Kennedy & Nourzad, 2016). More specifically, the well-developed literature on the exchange rates market-stock market nexus has been documented in developed economies. The association between the exchange rate and the stock market is explained through several models. The flow-oriented model of Dornbusch & Fischer (1980) - a good market approach - validates a positive relationship between exchange rates and stock prices. Much research has defined the exchange rate as crucial in stock market fluctuations, with a theoretical proposition originating in the flow-oriented model. Conversely, the portfolio balance model employed by Branson et al. (1977) identifies a negative relationship between stock prices and exchange rates. This portfolio balance model has also gained empirical support as financial markets become more integrated. Unlike the two mentioned models, the stock-oriented model argues no relationship between the exchange rates and stock markets. By applying various estimation methods, all empirical findings have presented mixed evidence concerning the relationship between exchange rates and the stock market in different areas and periods, and there is partial support for each model. However, the relationship does not obtain a consistent result in the literature.

Likewise, the empirical findings conducted in developed countries and more and more research for emerging market countries has presented evidence to confirm the theoretical exchange rates-stock market nexus rooted in the literature. (See Figure 4.2 in APPENDIX 4.A)

H4: Exchange rate has a significant positive/negative impact on stock market liquidity in EMEs.

4.2.5. Economic growth rate and stock market liquidity

Economic growth boosts the country's capacity to produce goods and services over time. High economic activity in a nation leads to higher incomes, which results in higher investments and, thus, a rise in stock returns (Mishkin, 2018). However, the increase in sentiment and loss of confidence in the economy during the economic downturn may decrease investment and activities in the stock market.

The impact of economic growth on financial development in general and SML in particular is proposed by the demand-side causality in the literature (Saganga, 2020). The theoretical perspective on the causality of economic growth on financial development (especially stock market development) is less developed than the financial system's causality on economic growth (Ho & Njindan Iyke, 2017). When economic growth rises, the financial system can remain activities sufficient and cost-effective. Greenwood & Smith (1997) presumed that economic development allows more financial inclusion in the financial system due to the fixed cost decrease informing financial intermediaries.

Although Siegel (1998) was the first person who started the absence of the positive growth-return association, the study of Hou & Cheng (2010) validated positive short-run causality flowing from economic growth to stock market development in this supportive line with the argument. Concurring with the previous finding of the "demand-following" hypothesis, many researchers have continuously documented the positive correlation between economic growth and the stock market in the short and long run, even though Attari & Safdar (2013) contended no relationship between the two of these variables appears in Pakistan in the long run. Contrary to the theoretical view of the positive nexus in the literature, some research discloses that economic growth negatively impacts the stock

market, such as Siegel (1998), Elroy Dimson et al. (2002), Ritter (2005), Osamwonyi & Evbayiro-Osagie (2012). In addition, some other studies presented evidence that there is no relationship between the two variables. (See Figure 4.2 in APPENDIX 4.A)

H5: Economic growth rate has a significant positive/negative impact on stock market liquidity in EMEs.

4.2.6. Inflation rate and stock market liquidity

High inflation raises living costs and a resource shift from stock market instruments to consumables, resulting from a drop in the demand for stock market instruments, decreasing trading volume and hence no increase in the price of traded stock value (Mishkin, 2018). Inflation is assuredly one of the most crucial macroeconomic factors concerning stock prices and is also impacted by it (Gupta & Inglesi-Lotz, 2012). The theoretical and empirical literature results on the relationship between inflation (e.g. CPI, WPI) and SML (e.g. stock prices, stock returns, stock index). Some views presume a positive relationship, while others state a negative one. The positive relation is commonly validated in the Fisher Hypothesis (Fisher, 1930), assuming nominal stock returns are a hedge against inflation. Some research confirms this positive relation employed in the advanced economies (e.g. Firth, 1979; Hayworth & Abdullah, 1993; Asai & Shiba, 1995; Graham, 1996; Ratanapakorn & Sharma, 2007). Although the positive relationship is firmly stated in the classical economic theories, there undoubtedly exists a negative relationship between inflation and SML. The evidence of the negative relation has been explained in several alternative proposals, and among them, the Proxy Hypothesis (Fama, 1981b) is mainly ensured by numerous empirical findings. Most empirical studies encouraged the negative correlation of these variables for the U.S and other developed countries.

Nevertheless, if the association between inflation and SML was evaluated by spanning long periods, the empirical results mostly supported Fisher's hypothesis, documented in advanced economies. Unexpectedly, several research studies have shown no relation between inflation and the stock market in the short or long run. Interestingly, the study of Alexakis et al. (1996) discovered that high inflation rates influence stock prices due to the volatility of inflation rates and primarily appear in emerging capital markets. (See Figure 4.2 in APPENDIX 4.A)

H6: Inflation rate has a significant positive/negative impact on stock market liquidity in EMEs.

4.2.7. The Treasury bill rate and stock market liquidity

Treasury bills are the least risky and most marketable of all securities (Elton & Gruber, 1995). The Treasury bill rate is generally known as a representative money market rate and a common measure of interest rate. Empirical studies undertaken in developed economies have extensively focused on the relationship between interest rates and SML (e.g. stock prices, stock returns, stock index). Interestingly, the influence of the Treasury bill rate on stock market performance studied over EMEs has gotten the great attention of researchersto date. Theoretically, as an interest rate measure, the Treasury bill rate has a negative impact on the stock index or stock prices, and this has been documented by numerous empirical studies. Similar to empirical research in developed countries, a positive relationship between treasury bill ratesand stock prices was reported in EMEs in the long run. In association with returns, some studies documented the significant negative effect of Treasury bill rates on the stock returns in the various market segments. (See Figure 4.2 in APPENDIX 4.A)

H7: The Treasury bill rate has a significant positive/negative impact on stock market liquidity in EMEs.

4.3. RESEARCH DATA AND MODEL

4.3.1. Data set

This study used secondary panel data with the selected criteria from seven countries in EMEs covering the period between 2000 and 2018. The seven selected EMEs included China, India, Mexico, Russia, Indonesia, Turkey and Poland⁷. For the analysis, besides macroeconomic data of the seven selected EMEs, the author considered data from seven major stock markets of these countries, namely Shanghai Stock Exchange (China), National Stock Exchange of India (India), Bolsa Mexicana de Valores (Mexico), Moscow Exchange (Russia), Borsa Istanbul (Turkey), Indonesia Stock Exchange (Indonesia) and Warsaw Stock Exchange (Poland) with all Chinese stocks, Indian stocks, Mexican stocks, Russian, Indonesian stocks, Turkish stocks and Polish stocks traded at each primary stock market. For variables measuring a SML, data were collected from Bloomberg and stock exchange websites. The considered stock scope included all stocks traded at the selected stock exchanges. The author collected and computed intraday measures for the selected stock markets. Then, daily figures were averaged to build a yearly figure because all MOP variables estimated were available on a yearly frequency. Markets cover the study in different time zones and trading times; thus, the author carefully addressed the issue of non-synchronous trading to avoid distorted results. For all macroeconomic variables concerning the conduct of MOP, data were available from Bloomberg, the World Development Indicators database of the World Bank.

⁷ <https://www.thestreet.com/markets/emerging-markets/what-are-emerging-markets-14819803>

4.3.2. Explained variable: Stock market liquidity measures

The previous literature proposes four main liquidity characteristics: trading quantity, execution time, transaction cost, and price impact. The reviewed studies by Kyle (1985), Harris (1990), and Baker (1996) have measured SML by using static and dynamic measures that can fairly capture the significant market liquidity characteristics, namely Resiliency, Depth, Tightness, and Immediacy. Apart from static and dynamic measures, Kutas & Végh (2005) completed the enumeration with a diversity dimension. Furthermore, liquidity measures are divided into onedimensional and multidimensional measures (Wyss, 2004). These measures were computed either based on intraday (high-frequency) data or daily, weekly, monthly, quarterly and yearly (low-frequency) data. In this study, the author employed several widely accepted liquidity measures to address the mentioned research hypotheses based on financial system characteristics (Martin et al., 2012) and indicators of liquidity dimensions (Kyle, 1985; Harris, 1990; Sarr & Lybek, 2002; Wyss, 2004; Kutas & Végh, 2005; Váradi, 2012; Octavio et al., 2013; PwC, 2015). Accordingly, there were five different measures, including Resiliency (price-related measure), Depth (volume-related measure or quantity measure), Tightness (spread-related measure or transaction cost measure), Immediacy (time-related measure or speed measure) and Diversity in the study. Following such research hypotheses, one-dimensional liquidity measures were used and evaluated by yearly data in this study. The detailed description of SML measures applied in this study is shared in APPENDIX 2.A.

4.3.3. Explanatory variable: Monetary policy measures

In line with previous literature, to investigate the impact of MOP on SML for this study, the author identified several MOP variables that could

capture the overview of MOP's influence. Firstly, for the MOP's transmission mechanism, the real interest rate, money base, and exchange rate were opted to research. Secondly, based on the ultimate objectives of a Central Bank, the author utilised real economic growth rate and inflation rate. Thirdly, the Treasury bill rate was also selected as a proxy for the interest rate of money market instruments, being an alternative to stocks and capturing possibly the opportunity cost of investment in the capital market. The detailed description of MOP measures employed in this study is presented in APPENDIX 2.B.

4.3.4. Control variables

Market capitalisation and financial globalisation can significantly influence the MOP-SML nexus. Hence, the author has considered the effect of these market conditions as control variables in the study.

Market capitalisation is the value of the total shares outstanding in the capital market following the stock's closing price (Silviyani et al., 2016). The greater market capitalisation will provide a positive signal that the outstanding stock's price is also high so that it is the potential to make high returns to investors (Menaje, 2012).

Globalisation in general and financial globalisation in particular has a meaningful effect on the financial market growth and development, having noted that financial globalisation caused the integration of domestic stock markets into other developed stock markets worldwide. Financial globalisation is the ongoing process of greater financial interdependence among countries, and it is identified by the increasing volume of international financial flows accompanied by liberalisation policies. As observed from the previous literature, globalisation or internationalisation of the stock market increases listing, capital raising and trading abroad in the domestic market (Oluwole, 2014).

All SML, MOP, and control variables are categorised and described in Table 2.1, in APPENDIX 2.A, and in APPENDIX 2.B.

4.3.5. Research model

The econometric analysis is based on panel data estimation, and a standard panel data model has the form in Equation (4.1):

$$y_{it} = \alpha_i + x'_{it}\beta + u_{it} \quad (4.1)$$

for $i = 1, \dots, N$ and $t = 1, \dots, T$

where α_i : a separate time period intercept, is independent of t .

β : a $K \times 1$ vector of parameters to be estimated.

x_{it} : a K -dimensional vector of explanatory variables.

u_{it} : an idiosyncratic error, varies over i and t .

N : is the number of cross-sectional units.

Regarding the mentioned hypothesis in Section 4.2, the fundamental functional relationship of this study could be developed as follows:

$$\text{SML} = f(\text{MOP}, \text{MAC}, \text{FIG})$$

In the estimable form, the general econometric equations of the study are from Equation (4.2) to Equation (4.9) as follows:

$$\begin{aligned} MEC_{it} = & \alpha_i + \beta_1 INRr_{it} \\ & + \beta_2 MB_{it} \\ & + \beta_3 LnEXR_{it} + \beta_4 GDPr_{it} + \beta_5 CPI_{it} + \beta_6 LnTBR_{it} \\ & + \beta_7 LnMAC_{it} + \beta_8 FIG_{it} + u_{it} \end{aligned} \quad (4.2)$$

$$\begin{aligned} LnQ_{it} = & \alpha_i + \beta_1 INRr_{it} \\ & + \beta_2 MB_{it} \\ & + \beta_3 LnEXR_{it} + \beta_4 GDPr_{it} + \beta_5 CPI_{it} + \beta_6 LnTBR_{it} \\ & + \beta_7 LnMAC_{it} + \beta_8 FIG_{it} + u_{it} \end{aligned} \quad (4.3)$$

$$\begin{aligned} LnV_{it} = & \alpha_i + \beta_1 INRr_{it} \\ & + \beta_2 MB_{it} \\ & + \beta_3 LnEXR_{it} + \beta_4 GDPr_{it} + \beta_5 CPI_{it} + \beta_6 LnTBR_{it} \\ & + \beta_7 LnMAC_{it} + \beta_8 FIG_{it} + u_{it} \end{aligned} \quad (4.4)$$

$$\begin{aligned}
\text{LogSrellog}_{it} = & \alpha_i + \beta_1 \text{INRr}_{it} \\
& + \beta_2 \text{MB}_{it} \\
& + \beta_3 \text{LnEXR}_{it} + \beta_4 \text{GDPr}_{it} + \beta_5 \text{CPI}_{it} + \beta_6 \text{LnTBR}_{it} \\
& + \beta_7 \text{LnMAC}_{it} + \beta_8 \text{FIG}_{it} + u_{it}
\end{aligned} \tag{4.5}$$

$$\begin{aligned}
\text{LnSeff}_{it} = & \alpha_i + \beta_1 \text{INRr}_{it} \\
& + \beta_2 \text{MB}_{it} \\
& + \beta_3 \text{LnEXR}_{it} + \beta_4 \text{GDPr}_{it} + \beta_5 \text{CPI}_{it} + \beta_6 \text{LnTBR}_{it} \\
& + \beta_7 \text{LnMAC}_{it} + \beta_8 \text{FIG}_{it} + u_{it}
\end{aligned} \tag{4.6}$$

$$\begin{aligned}
\text{LnN}_{it} = & \alpha_i + \beta_1 \text{INRr}_{it} \\
& + \beta_2 \text{MB}_{it} \\
& + \beta_3 \text{LnEXR}_{it} + \beta_4 \text{GDPr}_{it} + \beta_5 \text{CPI}_{it} + \beta_6 \text{LnTBR}_{it} \\
& + \beta_7 \text{LnMAC}_{it} + \beta_8 \text{FIG}_{it} + u_{it}
\end{aligned} \tag{4.7}$$

$$\begin{aligned}
\text{Lnn}_{it} = & \alpha_i + \beta_1 \text{INRr}_{it} \\
& + \beta_2 \text{MB}_{it} \\
& + \beta_3 \text{LnEXR}_{it} + \beta_4 \text{GDPr}_{it} + \beta_5 \text{CPI}_{it} + \beta_6 \text{LnTBR}_{it} \\
& + \beta_7 \text{LnMAC}_{it} + \beta_8 \text{FIG}_{it} + u_{it}
\end{aligned} \tag{4.8}$$

$$\begin{aligned}
\text{LnHHI}_{it} = & \alpha_i + \beta_1 \text{INRr}_{it} \\
& + \beta_2 \text{MB}_{it} \\
& + \beta_3 \text{LnEXR}_{it} + \beta_4 \text{GDPr}_{it} + \beta_5 \text{CPI}_{it} + \beta_6 \text{LnTBR}_{it} \\
& + \beta_7 \text{LnMAC}_{it} + \beta_8 \text{FIG}_{it} + u_{it}
\end{aligned} \tag{4.9}$$

where α_i : the intercept.

$\beta_1, \beta_2, \beta_3, \beta_4, \beta_5, \beta_6, \beta_7, \beta_8$: the slopes of the respective explanatory variables and control variables.

u_{it} : the error term accounting for the unmodellable influencing factors in the panel framework.

All variables measuring for SML were separately performed and evaluated in each econometric Equation of the study.

4.4. RESEARCH METHODOLOGY

Stage 1: Descriptive statistics

Descriptive statistics provide information for the initial generalisation of all variables in the empirical models.

Stage 2: Classic assumption tests

Before performing data analysis, the author investigated the data properties relating to classical assumptions to ensure that the regression models satisfy OLS estimators' assumptions. Thus, in order to test the classic assumption deviation, several tests were conducted: Linearity, Unusual and influential data, Normality of residuals, Correlation, Multicollinearity and Model specification.

Stage 3: Model specification

The author specified the research model, the Fixed-Effects Model, as the sample data is not random and comprises selected countries in the EMEs. Equation (4.1) is explained by the FEM in Equation (4.10) as follows:

$$y_{it} = \alpha_i + x'_{it}\beta + u_{it} = \alpha_i + x'_{it}\beta + \mu_i + v_{it} \quad (4.10)$$

for $i = 1, 2, \dots, N$, and $t = 1, 2, \dots, T$

where N = Number of individuals or cross-sections and T = The number of time periods.

α_i : the omitted variables, constant over time, for every unit i . The α_i are called fixed effects and induce unobserved heterogeneity in the model.

x'_{it} : the observed part of the heterogeneity.

u_{it} : the remaining omitted variables.

μ_i : a time-constant unobserved effect (or an unobservable individual-specific effect). It is a time-varying intercept that

captures all variables that affect y_{it} that vary over time but are constant cross-sectionally (Brooks, 2014).

v_{it} : a remainder disturbance.

In substituting all variables into the FEM, following Brooks (2014), the FEM of the study is presented in Equation (4.11) below:

$$SML_{it} = \alpha_i + MOP'_{it}\beta + LnMAC_{it}\beta + FIG_{it}\beta + \mu_i + v_{it} \quad (4.11)$$

Stage 4: Regression diagnostics concerning the characteristics of the selected panel data model

After the data selection and model specification, the author tested regression diagnostics concerning the characteristics of the panel data model as below.

Cross-sectional dependence (or Cross-sectional correlation):

After the model specification, the author was concerned with the cross-sectional dependency issue. When the panel data has $T > N$, the LM test, developed by Breusch & Pagan (1980), was utilised for detecting cross-sectional dependence issues.

Panel unit root test:

As a common accord in the literature, panel unit root tests are superior to unit root tests in time series analysis. All tests included in this study, called first-generation tests, are designed for cross-sectionally independent panels. This admittedly powerful assumption simplifies the derivation of the asymptotic distributions of panel unit root and stationarity tests considerably. The author included the panel unit root tests developed by Breitung (2000), Levin et al. (2002), Harris & Tzavalis (1999), and Im et al. (1997, 2003) (see Table 4.1 in APPENDIX 4.B).

Fixed effects (F-test):

It tests for the null hypothesis that all individual intercepts are equal to zero, i.e. $H_0: \alpha_i = 0$ in the regression model of Equation (4.10). More specifically, the result is an F-statistic (N-1, NT-N-K) that quantifies by how much the goodness-of-fit has changed (Park, 2011). In a regression of Equation (4.11), the null hypothesis is that all dummy parameters except for one for the dropped are all zero, $H_0: \mu_1 = \dots = \mu_{N-1} = 0$. This hypothesis is tested by an F-test based on loss of goodness-of-fit. If the null hypothesis is rejected, it means there is a significant fixed effect or a significant rise in goodness-of-fit in the fixed effect model; thus, the FEM is better than the pooled OLS.

Time-fixed effects:

To see whether time-fixed effects are needed when running the FEM, the author utilised a joint test to examine whether the dummies for all years are equal to 0. If the dummies are equal to 0, fixed effects are needed and vice versa.

Heteroskedasticity:

In many panel datasets, the variance among cross-sectional units can differ. Among the reasons responsible for this phenomenon, differences in the scale of the dependent variable between units are able to be quoted. In consequence, the author performed a modified Wald test to detect for the existence of groupwise heteroskedasticity in the residuals of the fixed-effect regressions. Under the null hypothesis (H_0 : Homoskedasticity), the error variance is the same for all individuals: $\sigma_i^2 = \sigma^2$, $\forall i=1, \dots, N$.

Autocorrelation within units:

According to Oscar (2010), serial correlation is responsible for too optimistic standard errors. To check for this complication, the author ran

Wald test where the null hypothesis assumes no first-order autocorrelation.

Endogeneity:

If variables are jointly determined by other variables in the model, we will face an endogeneity problem. In order to check whether there is an endogeneity problem in the regression models, the Durbin-Wu-Hausman test was used. The null hypothesis is that there is no endogeneity in the model.

Stage 5: Fixed-Effects Model and Feasible Generalised Least Squares estimations

This study utilised FEM with an AR(1) disturbance, as there is an autocorrelation in the panel. However, if Heteroskedasticity, Cross-sectional Correlation and Autocorrelation are in the regression analysis, some estimation methods for the long panel will consider this possible existence. According to Cameron & Trivedi (2009), the regression with the FGLS, the regression with PCSE, or the Pooled OLS/WLS or Fixed-Effects (within) regression with Driscoll & Kraay (1998) standard errors for coefficients could be one of the estimation options to ensure the sustainability of the research model.

4.5. EMPIRICAL ANALYSIS AND DISCUSSIONS

4.5.1. Descriptive statistics

The selected EMEs were preferred for this study due to the growing importance of their market-oriented economies and economic alliance with developed markets. They have jointly accounted for the largest share of global economic growth and the world's growing consumption. Their remarkable strides into development and vibrant financial markets attract much global attention, thereby attracting large capital inflow from the rest

of the world. Both Figure 4.3 and Figure 4.4 (see APPENDIX 4.C) visually describe the relationship between MOP and SML in EMEs during Crisis and Non-crisis periods.

Descriptive analysis is the fundamental analysis to describe the data state in general. Table 4.2 (see APPENDIX 4.C) provides a descriptive analysis of the collected explained variables (SML variables) and explanatory variables (MOP variables). All variables were calculated using financial ratios. From Table 4.2, a total of 133 samples (N) are observed.

For SML variables:

The Mean and Median of each SML variable reflect where the centre of data is located. Results of the Mean and the Median values presented in Table 4.2 were primarily close, except MEC and LogSrellog. It describes that the data of SML variables, including LnQ, LnV, LnSeff, LnN, Lnn, LnHHI are symmetrical, whereas the data of MEC and LogSrellog are skewed right (or positive). Measures of spread show the degree to which individual points are clustered about or deviate from the average value in the distribution. The Maximum and Minimum of each SML variable reflecting data range differed depending on its characteristics and internal and external conditions. The Maximum value of each SML variable is the largest data value in the distribution, and the Minimum value is the smallest. The standard deviation is a widely used measure of the data spread. Based on the descriptive statistical results of Table 4.2, the Standard Deviation of each SML variable was approximately from 0 to 3. It implies that 99.7% of the values fall within three standard deviations of the Mean, and more of the data observed were clustered tightly around the Mean of each SML variable. Moreover, each SML variables had a Mean more than the Standard deviation, except the MEC, LogSrellog. It

indicates more stable results, although the Mean and the Standard Deviation theoretically were different descriptive measures. Besides the characteristic of data spread, describing how the distribution rises and drops, known as the “shape” identification of the data, was shown in the descriptive statistics. For a normally distributed variable, the skewness and kurtosis coefficients are 0 and 3 (Gujarati et al., 2012). Based on the classic theory of Bulmer (1979), the Skewness of each SML variable, namely LnQ, LnV, LogSrellog, LnSeff, and LnHHI, was between -0.5 and +0.5, so each one is an approximately symmetric distribution. The data of LnN and Lnn was moderately skewed and skewed left, with the Skewness being between -1 and -0.5, while MEC got a highly and positively skewed distribution with a Skewness of 3.3060. Unlike Skewness, where they offset each other, Kurtosis is all about the distribution’s tails - not the peakedness or flatness. It is the measure of outliers present in the distribution. The Kurtosis of SML variables was almost leptokurtic (Kurtosis > 3), and only several variables were platykurtic (Kurtosis < 3), such as LnQ, LogSrellog and LnSeff. In comparison with a normal distribution, leptokurtic tails are longer and fatter, and often its central peak is higher and sharper, and vice versa (a platykurtic distribution).

For MOP variables:

Each MOP variable has a similar Mean and Median illustrated in Table 4.2, except INRr, MB, and CPI. The Mean values of these three MOP variables were more than their Median values. This means the data of MOP variables such as LnEXR, GDPPr, LnTBR, LnMAC and FIG are symmetrical, while the INRr, MB and CPI data are skewed right (or positive). Like SML variables, the Maximum of each MOP variable is the largest value of data in the distribution, and the Minimum is the smallest.

The Maximum and Minimum of each MOP variable had different values. Unlike SML variables, MOP variables, namely MB, INRr, CPI and GDP_r, had the high Standard Deviation indicating the data is spread over a wide range of values, except LnTBR and LnEXR. It also reflects unstable data with risk and market volatility. As figures are shown in Table 4.2 and the rule of thumb of Bulmer (1979), the Skewness of MOP variables was mostly greater than +1; thus, the data get a highly skewed distribution with the longer right tail. Only the data for GDP_r was approximately symmetric with a Skewness of -0.0575, whereas the distribution of LnTBR was moderately and positively skewed with a value of 0.6429. Interestingly, the Kurtosis values of all MOP variables were leptokurtic (Kurtosis > 3).

For control variables:

LnMAC and FIG had the Mean and Median values close, which explains that the two variables' data are symmetrical. Maximum and Minimum of LnMAC and FIG are the largest and smallest values of these control variables. It can be seen clearly from Table 4.2 that these two variables had a low Standard Deviation compared to the Mean. It implies that the data points are close to the Mean, and LnMAC and FIG have stable data. FIG was an approximately symmetric distribution with the Skewness of 0.2296, while the data of LnMAC was moderately and positively skewed with a value of 0.6087. In contrast with MOP variables, LnMAC and FIG were platykurtic distributions (Kurtosis < 3). Their tails are shorter and thinner, and the central peak is often lower and broader.

4.5.2. Classic regression diagnostic tests

The research data was examined, which is under consideration for some classical assumptions. The test results showed that the data meet the assumptions underlying OLS regression.

- Linearity:

The augmented component-plus-residual plots of each SML variable exhibited linear relationships between variables, even though some were slightly linear. (See Figure 4.5 in APPENDIX 4.D)

- Unusual and influential data:

The added-variable plots for all MOP variables computed by each SML variable quickly indicated that all data points seemed to be in range, and few outliers were observed in the plots. (See Figure 4.6 in APPENDIX 4.D)

- Normality of residuals:

The standardized normal probability (P-P) plots illustrated no indications of non-normality because the points of the variables somewhat lay on a relatively straight line except for the presence of a few random errors of several variables (MEC, INRr, MB, LnEXR, CPI). (See Figure 4.7 and Figure 4.8 in APPENDIX 4.D)

- Correlation:

The pairwise correlation was done between SML variables, MOP variables and control variables (LnMAC and FIG). According to Pearson's correlation coefficients reported in Table 4.3 (see APPENDIX 4.D), the correlations between each SML variable and each MOP variable were relatively weak with different signs (+/-) at the statistical significance of 5%. Resiliency measured by MEC had an inverse relation with INRr, FIG and direct relation with LnMAC. Depth measured by LnQ had a positive relation with INRr, MB, LNEXR, CPI, LnTBR, LnMAC and a negative relation with FIG. However, Depth measured by LnV had a positive relation with GDPPr, LnMAC and a negative relation with LnEXR, CPI, LnTBR and FIG. Tightness measured by LogSrellog directly related to INRr, MB, CPI, LnTBR, FIG and an inverse relation with GDPPr. Nevertheless, Tightness measured by LnSeff directly related

to INRr, LnEXR and LnTBR. Immediacy measured by LnN and Lnn had a negative relation with CPI, FIG and a positive relation with LnMAC. Diversity measured by LnHHI had an inverse relation with INRr, MB, LnEXR, CPI, LnTBR and a direct relation with FIG. It is noted that there exists a moderate correlation between INRr and MB, CPI, LnTBR; a weak correlation between INRr and LnEXR; a strong correlation between MB and CPI; a weak correlation between MB and LnEXR, LnTBR; a weak correlation between LnEXR and FIG; a strong correlation between CPI and LnTBR; a weak correlation between LnTBR and FIG in each SML variable model.

- Multicollinearity:

As the notice mentioned in the correlation of Table 4.3 (see APPENDIX 4.D), the correlation coefficient matrix between SML variables shows that most of the variables do not correlate, except some of them have a pretty strong correlation (such as MB, CPI and LnTBR). Moreover, it can be seen from Table 4.4 (see APPENDIX 4.D) that the VIF test averaged 2.85 (compared to the recommended level of 10). The author can conclude that no perfect or negligible multicollinearity between the variables can affect the estimation results.

- Model specification:

From Table 4.5 (see APPENDIX 4.D), the tests of $_hat{sq}$ were nonsignificant. It means we accept the assumption that the models are specified correctly or that there is no specification error in each equation. In addition, the figures shown in Table 4.6 (see APPENDIX 4.D) detected no omitted variables in each SML variable model. As a result, each SML variable model had no misspecification issues and no omitted variables.

4.5.3. Preliminary tests concerning panel regression diagnostics

- Cross-sectional dependence tests:

Breusch-Pagan LM test of independence is utilised to assess the correlation matrix of residuals. It can be seen clearly from Table 4.7 of the correlation matrix of residuals (see APPENDIX 4.E), the overall statistic $\chi^2 \left(\frac{N(N-1)}{2} \right)$ had a p-value < 0.05. It firmly rejected the null hypothesis for any confidence level, so the errors exhibited a cross-sectional correlation.

- Panel unit root tests:

The results from the panel unit root tests are subject to the inclusion or exclusion of a time trend. Table 4.8 (see APPENDIX 4.E) presents panel unit root tests according to Breitung, Harris and Tzavalis, LLC and IPS. As shown in Table 4.8, the panel unit root tests, which assume cross-section independence and include individual effects, rejected the null hypothesis of a common unit root and vice versa. It means the data of each model variable are generally stationary and nonstationary in different considerations.

- Fixed effects test:

Based on the “F test that all $u_i=0$ ” results of each SML variable in Table 4.13 (see APPENDIX 4.F), the p-value was small enough (at <0.01 level) to reject the null hypothesis. So there was a significant fixed effect, and the Fixed-Effects model was preferred over a Pooled OLS model.

- Time-fixed effects tests:

Controlling for constant variables across entities but vary over time can be done by including time-fixed effects. The author ran the time-fixed effects tests to see whether time-fixed effects are needed. The results provided by Table 4.9 (see APPENDIX 4.E) demonstrated that the null

that all year coefficients were jointly equal to zero was rejected in each SML variable model; therefore, time-fixed effects were needed, except the LnHHI model. In other words, estimating the combined country (stock market) and time-fixed effects model of the relation between SML and MOP is needed.

- Heteroskedasticity tests:

Based on the test results of each estimation in Table 4.10 (see APPENDIX 4.E), the overall statistic $\chi^2 (N)$ had a $p=0.0000$ in each SML variable regression. It led to firmly rejecting the null hypothesis for any confidence level. Thus, a phenomenon of heteroscedasticity was present.

- Autocorrelation within unit tests:

The P-value (<0.05) shown in Table 4.11 (see APPENDIX 4.E) led us to vehemently reject the null hypothesis and validate the presence of autocorrelation of the first order.

- Endogeneity tests:

The Durbin-Wu-Hausman test shown in the Table 4.12 reveals that no endogeneity problem exists in the model (see APPENDIX 4.E).

To sum up, according to the time-fixed effects test results, the author specified a two-way fixed effects model with both individual and time-specific effects. The error structure of the study was characterised by HPAC. However, controlling for these standard error complications depends upon the nature of the panel under study.

4.5.4. Fixed-Effects Model regression

The regression results from the estimation (see Table 4.13 in APPENDIX 4.F) demonstrate the impact of MOP on SML in the selected stock markets in EMEs during the Crisis and Non-crisis periods using two specific control variables (MAC and FIG).

Market resiliency:

In the model of MEC, there was a nonsignificant positive influence of LnMAC and FIG on MEC, and the Crisis's impact on MEC was less significant and positive. Accordingly, LnTBR (-2.7161) fairly significantly negatively affected MEC during the Crisis time. Like MOP variables in the Non-crisis, most MOP variables nonsignificantly affected MEC and had the same direction signs in the Crisis except the positive change in the sign of the INRr.

Market depth:

In the model of LnQ, LnMAC had a less significant adverse effect on LnQ, whereas FIG nonsignificantly negatively affected LnQ. There were only three MOP variables, namely INRr, CPI and MB, influencing LnQ in the Non-crisis with a positive significance (1%), a negative significance (1%) and a positive significance (10%), respectively. It can be seen clearly that the Crisis had a reasonably significant and positive effect on LnQ. MOP variables almost changed their signs during the Crisis, except for LnEXR. INRr and CPI, respectively, became negative and positive with a significance of 10%. *In the model of LnV*, both LnMAC and FIG nonsignificantly affected LnV with a negative sign. In the Non-crisis, four MOP variables, including MB (+), LnEXR (-), CPI (-) and LnTBR (+), impacted LnV at the statistical level of 1%, 1%, 1% and 5%, respectively. Likewise LnQ, the Crisis had a fairly significant positive influence on LnV. Some MOP variables changed their directions, including INRr (-), CPI (+) and LnTBR (-), even though they were nonsignificant, except CPI. There were only two MOP variables called CPI and GDPr that positively impacted LnV at the level of 5% and 10% statistics, respectively.

Market tightness:

In the model of LogSrellog, although LnMAC and FIG nonsignificantly influenced LogSrellog, they had various signs with LnMAC (-) and FIG (+). In the Crisis, there were four MOP variables impacting on LogSrellog such as INR (-), MB (+), LnEXR (-) and LnTBR (+), with different significance at 1%, 5%, 5% and 10%, respectively. Interestingly, the Crisis had a nonsignificant effect on LogSrellog, although most MOP variables changed their signs like INRr (+), MB (-), CPI (+) and LnTBR (-) during the Crisis period. *In the model of LnSeff*, LnMAC nonsignificantly negatively affected LnSeff, while FIG had a relatively significant positive effect on LnSeff. In the Crisis time, CPI, LnTBR and INRr impacted LnSeff with different signs at 1%, 1% and 5%, respectively. Unlike the LogSrellog, LnSeff was influenced significantly with a positive sign by the Crisis. There were changes in the signs of MOP variables, including MB (-), GDPPr (-), CPI (+) and LnTBR (-), although they were nonsignificant to LnSeff. Only LnEXR had a negative effect at the level of 10%.

Market immediacy:

In the model of LnN, LnMAC had a fairly significant negative effect on LnN, whereas FIG was nonsignificant to LnN. In the Non-crisis, all INRr (+), MB (+), CPI (-) and LnEXR (+) significantly influenced LnN at 1%, except LnEXR at 5%. Although the Crisis nonsignificantly impacted LnN, CPI had a significant positive effect on LnN. Besides, all MOP variables were nonsignificant and had changes in their directions. *In the model of Lnn*, likewise the LnN, both LnMAC and FIG had similar effects. MOP variables' influence on Lnn was the same as LnN during the Crisis and Non-crisis.

Market diversity:

In the model of LnHHI, both LnMAC and FIG nonsignificantly impacted LnHHI with positive and negative signs, respectively. In the Non-crisis, MB fairly significantly affected LnHHI, while LnEXR had a slightly significant positive effect on LnHHI. The Crisis was nonsignificant to LnHHI even though INRr and CPI changed their signs. All of the MOP variables had nonsignificant impacts on LnHHI during the Crisis.

Generally, in the FEM multiple regressions using two control variables referred to in Table 4.13 (see APPENDIX 4.F), the p-values associated with the F(32,94) statistics were still small enough (at <5%) to reject the null hypothesis. That means the models of SML variables using two control variables are significant. Nevertheless, all estimation results still reported that the MOP variables could explain less than 50% of the variation in each SML measure. It could be said that the MOP variables have low explanatory power over SML variables in seven selected EMEs during the Crisis and Non-crisis periods. It is noted that MOP variables influence SML differently depending on each SML characteristic. Moreover, in the “F test that all $u_i=0$ ” results of each SML variable, the p-value was small enough (at <1%) to reject the null hypothesis. Hence, there was still a significant fixed effect, and the Fixed-Effects model was preferred over a Pooled OLS model.

Summing up, *the estimation results of the FEM indicate that the impact of MOP on SML in EMEs is varied for Crisis versus Non-crisis times.* More precisely, in Crisis time, the MOP variables are mainly nonsignificantly related to each SML variable. However, most have changes in an impact state (positive or negative effect), and some have different effects during the Crisis. Only the Treasury bill rate significantly negatively affect Market resiliency (via MEC) during the Crisis. Inflation

rate and Economic growth rate positively impact Market depth (via LnQ and LnV) with different significance levels in the Crisis, whereas Interest rate has a slight negative impact (via LnQ). The Exchange rate slightly negatively influences Market tightness (via LnSeff) in the Crisis period. Only the Inflation rate positively affects Market immediacy (via LnN and Lnn) with a strong significance during the Crisis. Surprisingly, there is a nonsignificant impact of MOP on Market diversity (via LnHHI) during the Crisis time. Central Banks play an essential role in ensuring economic and financial stability. Under an inflation-targeting framework, the crucial role of Central Banks in the selected EMEs is to employ MOP to achieve price stability (low and stable inflation) and to help control economic fluctuations. Nevertheless, in line with previous research results, it can be seen clearly that most Central Banks in the selected EMEs were considerably in the expansionary phase of their cycle, and inflation gaps were positive during the Crisis time to cushion against the global financial shock and to foster economic recovery. At the peak of the GFC, more than 80 per cent of EMEs loosened MOP from the third quarter of 2008 to the end of the first quarter of 2009 (Coulibaly, 2012). Indeed, the estimated results indicate that several of MOP key variables highlighted the easing MOP of the selected EMEs in the Crisis even though MOP factors differently influenced each SML characteristic: lowered Interest rates (increasing loan demand), reduced the Treasury bill rate, raised GDP (boosting Economic growth), decreased the Exchange rate (depreciating currency), and increased CPI (rising inflation expectations). It also reveals that an expansionary MOP (i.e. lower interest rate) evidently leads to an increase in SML, which is consistent with previous research such as Goyenko & Ukhov (2009), Octavio et al. (2013), Chowdhury et al. (2018) and Debata et al. (2021). Enhancing market liquidity in stressful or

turbulent periods decreases the interest rate on the national debt, ensures that Treasury bills can be an effective safe haven when financial asset prices (e.g. stock prices) drop, and makes them the benchmark against risky financial assets priced.

By contrast, in Non-crisis times, most MOP variables differently have a significant impact on SML characteristics, except for Market resiliency. Interestingly, for the characteristic of Market resiliency, there is a nonsignificant influence of MOP on Market resiliency during the Non-crisis. For the characteristic of Market depth, most MOP variables (except Economic growth rate) strongly and significantly affect Market depth (via LnQ and LnV) with different signs in the Non-crisis. Interest rate, Monetary aggregates, and the Treasury bill rate positively affect Market depth, while the Exchange rate and Inflation rate have a negative effect. For the characteristic of Market tightness, like Market depth, MOP variables (except Economic growth rate) have a significant impact on Market tightness (via LogSrellog and LnSeff) with similar signs in the Non-crisis. However, only the Interest rate is varied with a negative sign. For the characteristic of Market immediacy, most MOP variables (except the Economic growth rate and the Treasury bill rate) still significantly influence Market Immediacy (via LnN and Lnn) with different signs in the Non-crisis. Only the Inflation rate negatively affects Market Immediacy, whereas Interest rate, Monetary aggregates, and the Exchange rate have a positive effect. For the characteristic of Market diversity, Monetary aggregates significantly negatively impact Market diversity (via LnHHI), while the Exchange rate slightly positively impacts Market diversity during the Non-crisis periods. Like previous studies in the Non-crisis times, with the official and unofficial policy framework of inflation targeting, the Central Banks of these EMEs tend to pursue the MOP of “Leaning against the wind” (of asset prices and

credit booms) involves a higher policy interest rate. Accordingly, although there were some changes in the signs of some MOP variables such as Monetary aggregates, Interest rate and Exchange rate in the Non-crisis periods due to different points of time for applying the contractionary MOP in each selected emerging country, most MOP variables highlighted the tightening MOP of EMEs throughout these periods.

Noticeably, there is a slight relationship between Market capitalisation, Financial globalisation and each SML characteristic (such as Market depth, Market tightness and Market immediacy), although they are positive or negative. Market capitalisation negatively affects Market diversity (via LnQ) and Market immediacy (via LnN and Lnn) with various significance levels, while Financial globalisation only has a significant positive effect on Market tightness (via LnSeff).

4.5.5. Feasible Generalized Least Squares regression

In order to correct the error structure of this study called HPAC, the regression estimation with the FGLS method was used to provide stable estimation results (see Table 4.14 in APPENDIX 4.G).

Market resiliency:

In the model of MEC, LnMAC and FIG nonsignificantly affected MEC with positive and negative signs, respectively. MOP variables had a nonsignificant influence on MEC in the Non-crisis time, and the Crisis had a relatively significant positive impact on MEC. While MOP variables nonsignificantly affected MEC and did not change their directions, GDP_r and LnTBR became slightly significant to MEC during the Crisis.

Market depth:

In the model of LnQ, although LnMAC and FIG significantly influenced LnQ, they had changes in their signs. Only INR_r and LnEXR affected LnQ in the Non-crisis with a positive significance at 1%. The Crisis had a

positive and significant effect on LnQ. In more detail, GDP_r and LnEXR positively impacted LnQ during the Crisis period at the level of 5% and 10%, respectively. Meanwhile, other MOP variables were nonsignificant to LnQ even though INR and MB changed their signs. ***In the model of LnV***, both LnMAC and FIG significantly influenced LnV with different signs. In the Non-crisis, LnEXR significantly negatively impacted LnV, while INR_r (+) and CPI (-) slightly affected LnV. Other MOP variables were nonsignificant to LnV in the Non-crisis. Although the Crisis had a nonsignificant effect on LnV, INR_r and GDP_r significantly affected LnV differently. Other MOP variables had a nonsignificant impact on LnV, and INR and CPI changed their directions during the Crisis.

Market tightness:

In the model of LogSrellog, both LnMAC and FIG also significantly positively influenced LogSrellog. In the Non-crisis time, there was merely LnEXR being more significant to LogSrellog, whereas most MOP variables changed their signs and were nonsignificant. The Crisis nonsignificantly impacted on LogSrellog. INR_r (+), MB (-) and LnEXR (-) became highly significant to LogSrellog even though other MOP variables had a nonsignificant effect. Besides, there were some changes in the signs of MOP variables, namely LnEXR, GDP_r and LnTBR, which were negative, positive, and positive. ***In the model of LnSeff***, LnMAC had a nonsignificant negative influence on LnSeff, while FIG significantly positively affected LnSeff. Only LnEXR and LnTBR had a highly significant positive impact on LnSeff in the Non-crisis. The rest MOP variables were nonsignificant to LnSeff during this time. Though the Crisis had a significant positive effect on LnSeff, only GDP_r slightly influenced LnSeff. Moreover, most MOP variables tend to change their directions in the Crisis period except MB.

Market immediacy:

In the model of LnN, while LnMAC was nonsignificant to LnN, FIG had a significant negative effect on LnN. In the Non-crisis time, most MOP variables were nonsignificant to the LnN except LnEXR (-) and INRr (+) impacted the LnN with the significance level of 1% and 10%, respectively. The Crisis highly significantly influenced the LnN. However, it only caused some changes in the directions of three MOP variables called INRr (-), LnEXR (+) and CPI (+). *In the model of Lnn*, though the regression coefficients were different values, the impact of MOP variables on Lnn was similar to that of the LnN.

Market diversity:

In the model of LnHHI, both LnMAC and FIG significantly positively influenced LnHHI. In the Non-crisis, INRr and LnEXR negatively affected the LnHHI with a statistical significance level of 1%, whereas CPI had a slightly positive effect on the LnHHI. Although the Crisis had an nonsignificant negative impact on the LnHHI, there were considerable changes in the signs of MOP variables except for MB.

To sum up, *in the FGLS regressions* shown in Table 4.14 (see APPENDIX 4.G), *the estimation results reveal that the effect of MOP variables on each SML characteristic varies significantly during the Crisis versus Non-crisis time*. More specifically, during the Crisis time, the significant effects of MOP variables on SML characteristics remarkably changed even though the Crisis had a nonsignificant impact on MOP or SML. It can be seen clearly that Economic growth, Interest rate, Exchange rate, Monetary aggregates and the Treasury bill rate affected SML characteristics in different directions and significance during the Crisis. Some MOP variables, namely Interest rate, Monetary aggregates, the Exchange rate and Economic growth rate, have a significant influence on Market tightness (via LogSrellog and

LnSeff), except Economic growth has a slight influence. Others (Interest rate, Economic growth and the Exchange rate) affect Market Depth with various significance. Besides, Economic growth and the Treasury bill rate have a slightly negative effect on Market resiliency at this Crisis time. In this study, taking into account the presence of heteroskedasticity, serial, and cross-sectional correlations in the relationship between MOP and SML via the FGLS estimator asserts strategy similarities in the implementation of the easing MOP in the selected EMEs throughout the Crisis period. Reality pointed out that the Central Banks of these EMEs pursued the tightening MOP following the inflation targeting framework before shifting to loosened MOP during the Crisis. However, depending on each country's characteristics and economic environment, Central Banks conducted the expansionary MOP to stimulate economic activity without concerns about fueling inflation at different points in this Crisis period. Several noticeable changes in the signs of MOP variables such as Interest rate, Monetary aggregates, Economic growth and Exchange rate were considered concrete pieces of evidence to explain the Crisis period.

In the Non-crisis, four MOP variables affect SML characteristics: the Exchange rate, Interest rate, Inflation rate, and Treasury bill rate. Among these MOP variables, the Exchange rate has a highly significant impact on SML characteristics (Market depth, Market tightness, Market immediacy and Market diversity) with a positive or negative sign. It can be clearly explained by the strong significance of Financial globalisation in the estimation. Similarly, Interest rate positively or negatively affects Market depth, Market Immediacy and Market diversity with a lower significance. The Inflation rate slightly influences Market depth and Market diversity, while the Treasury bill rate only has a highly positive impact on Market tightness. Apparently, based on the FGLS estimator, the policy strategy

within which Central Banks of these EMEs operate was the contractionary MOP over pre-and post-Crisis times, in line with previous studies. Nevertheless, it confirmed that points of time when these Central Banks started to tighten MOP were different in both pre- and post-Crisis periods. Accordingly, the signs of MOP variables, including Interest rate, Inflation rate, and Exchange rate, reasonably changed in Non-crisis times.

Along with the special features of the FGLS regression allowing the error structure “HPAC”, both Market capitalisation and Financial globalisation impact SML characteristics (except for Market resiliency) even though their signs are different. Interestingly, Financial globalisation strongly affects each SML characteristic, and it is a reasonable explanation for a strong significant impact of the Exchange rate on each SML characteristic, except for Market resiliency.

4.6. CONCLUSIONS AND RECOMMENDATIONS

The study has shed light on MOP’s role in the macroeconomic management of a nation in general and a stock market in particular. The author investigated the impact of MOP on SML in EMEs in Non-crisis and Crisis periods. The findings can be summarised as follows.

Concerning the FEM estimation:

Firstly, in Non-crisis periods, the Interest rate has a significant positive/negative effect on some characteristics of SML, including Market depth, Market tightness and Market immediacy, whereas it only has a slightly negative influence on the characteristic of Market depth in the Crisis period. *Secondly*, in Non-crisis periods, Monetary aggregates have a significant positive/negative impact on Market depth, Market tightness, Market immediacy and Market diversity, while it does not affect any SML characteristics in the Crisis period. *Thirdly*, likewise Monetary aggregates, the Exchange rate positively/negatively influences Market

depth, Market tightness, Market immediacy and Market diversity in the Non-crisis period, whereas it merely has a slight negative impact on Market tightness in the Crisis period. *Fourthly*, the Economic growth rate does not affect SML in Non-crisis times, but it slightly and positively influences Market depth in Crisis time. *Fifthly*, the Inflation rate has a significant negative impact on Market depth, Market tightness and Market immediacy in Non-crisis periods, while it changes positively, affecting Market depth and Market immediacy in the Crisis period. *Sixthly*, the Treasury bill rate significantly positively impacts Market depth and Market tightness in Non-crisis times, whereas it has a significant negative effect on the characteristic of Market resiliency in Crisis.

Concerning the FGLS estimation:

Firstly, in Non-crisis periods, the Interest rate has a significant positive/negative effect on Market depth (+), Market immediacy (+) and Market diversity (-), whereas it changes in the significant negative impact of Market depth (-) and it significantly positively influences Market tightness in the Crisis period. *Secondly*, Monetary aggregates and Economic growth rate do not affect SML in Non-crisis periods, while in the Crisis period, Monetary aggregates significantly influence Market tightness and Economic growth rate has a significant positive impact on Market depth, and a slight impact on Market resiliency and Market tightness with its sign (+/-) changes. *Thirdly*, the Exchange rate has a significant positive/negative effect on Market depth, Market tightness, Market immediacy and Market diversity in the Non-crisis period, whereas it only has a significant negative impact on Market tightness and a slightly positive impact on Market depth in the Crisis period. *Fourthly*, the Inflation rate merely has a slight positive/negative effect on Market depth and Market diversity in Non-crisis times, while it does not affect

SML in Crisis times. *Fifthly*, the Treasury bill rate significantly positively impacts Market tightness in Non-crisis times, but it has a slightly negative effect on Market resiliency in Crisis time.

Brief to conclude, *selected sample MOP variables influence SML in EMEs during Crisis and Non-crisis times, confirming all hypotheses from H1 to H7 even though the impact levels and signs are different in each SML characteristic.* The static panel estimation results suggest that the selected EMEs conducted an expansionary MOP, significantly leading to a rise in SML during the Crisis period. Several major MOP variables revealing this easing MOP during the Crisis include the Interest rate, the Treasury bill rate, Inflation rate, Economic growth, and the Exchange rate. Moreover, the tendency to implement the tightening MOP for most EMEs is confirmed in the Non-crisis periods (Pre-crisis: 2000-2006 and Post-crisis: 2010-2018). It is detected through some main MOP variables such as the Interest rate, the Treasury bill rate, the Inflation rate, the Exchange rate and Monetary aggregates. More specifically, Interest rate and Inflation rate are considered essential MOP aspects to SML in Crisis and Non-crisis times. Along with the Interest rate, which is a vital tool of MOP, the Treasury bill rate often tends to noticeably affect SML in both Crisis and Non-crisis periods due to the “risk-free” characteristic of the Treasury bill, in particular on the financial markets of the EMEs. Because of financial globalisation, the Exchange rate also influences SML during Crisis and Non-crisis times; especially, it becomes more significant to most SML characteristics in Non-crisis times. Based on the “inflation targeting” framework in the EMEs, which is focused primarily on achieving low and stable inflation, supportive of the economy’s growth objective, Economic growth is crucial to SML in the Crisis, while Monetary aggregates are of great concern to enhance SML in the Non-crisis times.

The outcomes of this study have several necessary implications. Interest rate, the Treasury bill rate, Inflation rate, Monetary aggregates and Economic growth are considered significant variables affecting SML (especially the three key variables: Interest rate, the Treasury bill rate, and Inflation rate), so Central Banks should try to control and maintain them through the MOP instruments. In addition, the Exchange rate variable reflects vital information to predict stock market performance in general and SML in particular. Central banks' regulators should maintain a healthy and flexible Exchange rate due to the considerable effects of Financial globalisation.

4.7. LIMITATIONS

By filling out research gaps, this study has continuously improved the existing literature on the relationship between MOP and SML in EMEs, especially during periods of Crisis and Non-crisis. Despite this, there are some limitations to be further clarified in this research topic.

First, the study merely indicated the static impact of MOP on SML in EMEs throughout the research period. The linkage between them will become more insightful if assessed in different states (static, dynamic and spatial approaches).

Second, the study only investigated the relationship between MOP and SML for the whole group of selected EMEs. The answers to the influence of MOP on SML in each selected country of EMEs still need to be solved. This study leaves some doors opening to future research. Future research could address these limitations, especially considering the dynamic correlation between MOP and SML in EMEs.

CHAPTER 5



CHAPTER 5

THE CAUSAL LINKAGE BETWEEN MONETARY POLICY AND STOCK MARKET LIQUIDITY IN EMEs: A PANEL CS-ECM APPROACH

ABSTRACT

The study investigates the causal linkage between MOP and SML for seven selected stock markets in EMEs in the short and long term. Countries group during the 2000-2018 periods. Four stages were employed: tests to clarify the order of stationarity, tests to identify the interdependence, tests to verify the existence of cointegration, tests to detect the causal correlations, and finally, the cross-sectionally augmented error correction approach to assess the short- and long-run effects. The results approved the cointegration between variables, confirming the long-run relationship. Furthermore, the Granger causality results revealed different outcomes (unidirectional and bidirectional) concerning the causal association between MOP and SML. Additionally, the CS-ECM approach resulted in short- and long-term MOP effects on SML in EMEs even though their significance level and sign were varied.

All in all, these results remind the awareness of the macroeconomic management role of MOP, considered a suitable candidate to ensure financial system stability in EMEs in general and enhance SML in specific. Consequently, to achieve these goals, stock markets in EMEs need to be further developed through appropriate regulatory and macroeconomic policies (primarily MOP).

5.1. INTRODUCTION

The relationship between the stock market and macroeconomic policies (especially MOP) has become an area of interest since financial crises have severe economic consequences. MOP - one of the macroeconomic policies - is “a tool” to manage the money supply and liquidity, which have an ultimate goal of price stability and low unemployment; and the stock market - a barometer of business and economy - provides a capital opportunity to corporate sectors for business financing (Okpara, 2010). The nature of the association is necessary to investigate as price stability is MOP’s principal aim, and the stock market is a critical unit in the economy (Bernanke & Gertler, 1999). As a result, the answers for the valuable role of MOP to SML and their association, including their causality in the financial system, are necessary for economic objects (like authorities, policymakers and investors) to fulfil their significant targets. More specifically, it has become significant to evaluate the correlation of MOP and SML in the EMEs when this economic area is known as the best-performing role for global economic growth. Identified as low- to middle-per-capita income, less-developed countries with the potential for development, EMEs have different high volatilities, stock return properties, and risk-return characteristics than their mature counterparts in developed countries. Most stock markets in this area still have limitations in their essential economic function providing significant direct capital for a national economy. Moreover, the rapid developments of these markets in globalisation and their crucial role in the world economy have contributed to the increased attention from macro-and microeconomic subjects focusing on EMEs.

Numerous research has been conducted for specific countries to understand better the connection between MOP and SML in the emerging

market area. Most of these studies recognise their relationships and discuss them in one way or another based on various perspectives and approaches. Nevertheless, some noticeable drawbacks remain. First, the study was based on the premise that “it is possible that the unconditional distribution of asset returns may become normal once the static and dynamic relationships are accounted for” (Markellos, 1994, 2002). To put it simply, the insight correlation between MOP and SML from the static and dynamic angles becomes necessary to evaluate. Few studies have investigated their causal relationship by utilising panel data analysis with a dynamic model approach in the empirical literature. Second, most causal associations have been only captured through several MOP properties and SML characteristics. Third, the causality of MOP and SML has been documented in developed economies, a mix of developed, developing and emerging markets, some EMEs or a specific emerging market, not based on benchmark similarities relating to major research factors.

To the author’s knowledge, the study improves the existing empirical literature to fully assess the causal relationship between MOP and SML in EMEs via all MOP properties and SML characteristics captured. Their causality is revisited in seven selected EMEs whose benchmark similarities in MOP targeting and stock market sustainable objectives, applying the dynamic panel model approach of “the CS-ECM”. In addition, this causal correlation is taken into account the significant changes in market capitalisation guiding an investment strategy (Menaje, 2012) and changes occurring as a result of globalisation and financial openness (Hasan & Javed, 2009).

The entire study is organised: The “Literature review” section summarises the theoretical and empirical literature on the causal linkage between MOP and SML in EMEs and identifies research gaps. The “Data and

methodology” section explains the data and method conducted in the study. The “Empirical analysis and discussions” section provides the study’s quantitative analysis. The “Conclusions and recommendations” section showcases the findings and conclusions drawn from the analysis, even necessary recommendations. The “Research limitations” section provides limitations and scope for future research.

5.2. LITERATURE REVIEW

5.2.1. The causal relationship between monetary policy and stock market liquidity in emerging market economies

There has been ample empirical research examining the relationship between the stock market and the macroeconomy (Borjigin et al., 2018). Among the relationships, identifying the causality between MOP and SML variables has become an area of interest. The empirical literature on the causal linkage of MOP and SML has been mixed evidence in developing and emerging economies. Several studies document a significant MOP-SML nexus, while some do not show causality. For instance, *in Turkey*, Demir (2019) also discovered that GDP and domestic currency positively influence the stock market’s enhancement. At the same time, the interest rate reacts oppositely to the Turkish stock market over a period from 2003 to 2017 by using quarterly data under ARDL. *In Pakistan*, Ahmad (2007) indicated that the money supply causes the stock prices in Pakistan in both the short and long run. Mustafa et al. (2013) disclosed that stock prices negatively cause the money supply in Pakistan in the short term. The money supply did not determine the stock price in the long term from January 1992 to June 2009 by utilising cointegration, ECM and Granger causality techniques. *In Nigeria*, Okpara (2010) concluded that MOP negatively harms the long-run stock market returns from 1985 to 2006 by

utilising a VECM and the Forecast Error Decomposition analysis. *In India*, Tripathy (2011) indicated bi-directional relationships between interest rate and the stock market, exchange rate and stock market with the Granger-causality test from 2005 to 2011. *In Malaysia*, Mohamadpour et al. (2012) detected the positive long-term relationship of money supply on the stock index in Malaysia from 1991 to 2011 by applying Cointegration analysis and VECM. *In China*, Borjigin et al. (2018) discovered the linear and nonlinear dynamic correlation between stock prices and macro economy from January 1992 to March 2017, and stock prices have the “national economic barometer” functions. Similarly, some research comparing the causal phenomenon of MOP and SML for a group of countries has continuously obtained mixed findings. Numerous studies have utilised time series data with a dynamic analysis approach to evaluate the causal association between MOP and SML, mainly through ARDL, ARIMA and VECM frameworks. In contrast, few studies have followed a panel dynamic model approach to reveal their causality.

Indeed, most studies have provided different findings according to the macroeconomic factors used, the research methodology employed, and the countries examined. The review of the existing literature does not find any consensus on whether MOP thoroughly influences the characteristics of SML in EMEs and their inverse association. Furthermore, no representative empirical works for the EME area investigate the interrelationship between the MOP environment and SML in emerging markets that consider similarities in MOP implementation and stock market sustainable objectives, even though several studies for the EMEs have been carried out so far. (See Figure 5.1 in APPENDIX 5.A).

H1: There exists a significant causal relationship between monetary policy and stock market liquidity in emerging economies in the short and long run.

5.2.2. Interest rate and stock market liquidity

The theoretical and empirical literature has validated the existence of the causal association between interest rate and SML (e.g. stock price, stock return, stock index) as well as their short- and long-time correlations around the world. Although a traditional view of “a negative one-way relationship from interest rate to SML” is asserted chiefly in literature, their presence and nature of the relationship concerning the causality seem uncertain, varying from one country to another.

More specifically, the literature concedes a negative correlation between interest rates and stock returns (e.g. Mishkin et al., 1977; Alam & Uddin, 2009; Miseman et al., 2013; Ibrahim & Musah, 2014; Nordin et al., 2014; etc.) based on the classical interest rate theory. In other words, a negative coefficient with causality running from interest rates to stock prices is usually expected. A rise in interest rate supports more savings in banks and declines the capital flow to the stock market and vice versa. In supporting the traditional theory, most studies have documented a significant negative relationship between interest rates and stock prices in developed, developing and emerging countries. In contrast to the classical theory, some studies reveal inconsistent findings asserting a presence of a positive connection between interest rate and SML, especially during some special periods (e.g. Wongbangpo & Sharma, 2002; Hunjra et al., 2014; Subburayan & Srinivasan, 2014; etc.). They discovered a change in the direction of the relationship between interest rates and SML. Surprisingly, some studies obtained a unidirectional causality flowing from stock price to interest rate (e.g. Cheung, 1990; Mok, 1993; Wang,

2010; etc.). Unlike the usual findings of other studies, some studies signified a bi-directional relationship between interest rates and SML (e.g. Rashid, 2008; etc.), while others indicated that the causal association between the interest rate and SML does not exist (e.g. Naik, 2013; Subburayan & Srinivasan, 2014; Archana, 2016; etc.). Likewise the causality, changes in interest rates, which are expected to affect SML in the short and long term, also show mixed results with different signs. Interest rates impact stock prices in the short run (e.g. Wongbangpo & Sharma, 2002; Issahaku et al., 2013; etc.) or in the long run (e.g. Bulmash & Trivoli, 1991; Wongbangpo & Sharma, 2002; Muktadir-al-Mukit, 2013; Musawa & Mwaanga, 2017; etc.) or in both short and long run (e.g. Rashid, 2008; Hunjra et al., 2014; Nordin et al., 2014; etc.). (See Figure 5.1. in APPENDIX 5.A)

H2: There exists a significant causal relationship between interest rates and stock market liquidity in EMEs.

5.2.3. Monetary aggregates and stock market liquidity

Numerous research has primarily investigated the causality and short- and long-term correlations between monetary aggregates and SML via the connection of money supply and SML (e.g. stock price, stock return, stock index). Accordingly, the literature documents a mixed picture with the relationship dependent on the expected future influences of the change in money supply on economic conditions and interest rates.

In general, there are two main approaches regarding the relationship between money supply and SML. The first approach is addressed in the competing theories established by Keynesian economists and other real activity theorists. Keynesian economists argue that money supply and stock prices are negatively associated, and the influence of money supply on stock prices depends on expected future MOP. Some studies confirm the

negative relationship between money supply and stock prices and also support Keynesian views (e.g. Pearce & Roley, 1985; Rapach, 2001; Raymond, 2009; Okpara, 2010; Garnia et al., 2022; etc.). On the other hand, as concurred by real activity theorists, an increase in the money supply means more money demand in the market due to increased economic activities. High economic activity positively affects the firms' profit and stock prices. Some studies obtain a positive association between money supply and stock prices (e.g. Maysami & Koh, 2000; Büyüksalvarci & Abdloğlu, 2010; Bissoon et al., 2016; Pícha, 2017; Sahu & Pandey, 2020; etc.). The second approach is disclosed in work by Friedman (1988), who argued that an increase in stock price has a positive wealth influence and a negative substitution influence on the demanded quantity of money. The outcomes of many studies encourage the presence of a positive wealth effect and a negative substitution effect; however, results are sensitive to the period and data (e.g. Mc Cornac, 1991; Choudhry, 1996; Abdelbaki, 2013; Khan et al., 2017; etc.). Additionally, few studies discovered their bi-directional linkage (e.g. Seong, 2013; Khan et al., 2017; etc.), while some studies found no relationship between money supply and SML (e.g. Bhattacharya & Mukherjee, 2006; Alatiqi & Fazel, 2008; Kandir, 2008; Ali et al., 2010; etc.). In line with the causal correlation, there have been outcomes with different signs explored in numerous studies in both the short and long run (e.g. Husain & Mehmood, 1999; Maysami et al., 2005; Pícha, 2017; etc.) or in the short run (e.g. Pilinkus & Boguslauskas, 2009; Mustafa et al., 2013; etc.) or mainly in the long run (e.g. Mukherjee & Naka, 1995; Kwon & Shin, 1999; Sohail & Hussain, 2009; Sahu & Pandey, 2020; etc.) (See Figure 5.1. in APPENDIX 5.A)

H3: There exists a significant causal relationship between monetary aggregates and stock market liquidity in EMEs.

5.2.4. Exchange rate and stock market liquidity

The theoretical literature proposes several models to explain the interaction between exchange rates and SML (e.g. stock price, stock return, stock index). Accordingly, the theoretical consensus concerning their correlations can be derived from two widely utilised models, namely the “flow-oriented” model (Dornbusch & Fischer, 1980) and the “stock-oriented” (Frankel, 1983; Branson & Henderson, 1985). The “flow-oriented” model (Dornbusch & Fischer, 1980) - the traditional approach - assumes that exchange rates cause changes in stock prices and suggests a positive relationship between them. More precisely, when the domestic currency depreciates (appreciates), the costs of export become lower (higher), the local firms become more (less) competitive and increase (decrease) their exports. It leads to a rise in the stock prices of domestic firms. The “stock-oriented” model (Frankel, 1983; Branson & Henderson, 1985) posits that the exchange rate is determined by the supply and demand of financial assets (equities and bonds). This model is further classified into the portfolio balance and monetary models. The portfolio balance model postulates that changes in stock prices affect the exchange rate and states a negative relationship between them. In this model, variations in stock prices can influence capital account transactions claimed to be the critical determinant of exchange rates. The monetary model assumed weaker or no linkages between the exchange rate and stock prices. In this model, the exchange rate is considered to be the price of an asset. The factors that cause changes in exchange rates may differ from those that bring changes in stock prices. Thus, there may be no relationship between the exchange rate and stock prices in such conditions. The empirical literature provides mixed evidence about the association between exchange rates and the SML in the short and long time and their causality. Interestingly,

numerous investigated studies have suggested that the relationship between exchange rates and SML may be established in the short run (e.g. Nieh & Lee, 2001; Smyth & Nandha, 2003; Parsva & Lean, 2011; Sui & Sun, 2016; etc.). Some studies have found evidence of the long-run correlation between two variables (e.g. Akel et al., 2016;), whereas some have explored both short- and long-run relationships (e.g. Ajayi & Mougoué, 1996; Parsva & Lean, 2011; etc.). Most studies have presented evidence that a one-way causality moves from exchange rate to stock prices (e.g. Granger et al., 2000; Kang et al., 2013; Amin & Janor, 2016; Lakshmanasamy, 2021; etc.). Some studies have obtained the existence of a causal relationship flowing from stock prices to exchange rate (e.g. Ajayi et al., 1998; Diamandis & Drakos, 2011; Lin, 2012; Huy, 2016; etc.). Some studies have disclosed the bi-directional connection between stock prices and exchange rates (e.g. Bahmani-Oskooee & Sohrabian, 1992; Zhao, 2010; Parsva & Lean, 2011; Andreou et al., 2013; Nguyen, 2019; etc.). Other studies could not establish any relationship between exchange rate and SML, even in the long run (e.g. Bahmani-Oskooee & Sohrabian, 1992; Granger et al., 2000; Nieh & Lee, 2001; Rahman & Uddin, 2009; Parsva & Lean, 2011; Lin, 2012; Zakaria & Shamsuddin, 2012; etc). (See Figure 5.2. in APPENDIX 5.A)

H4: There exists a significant causal relationship between exchange rate and stock market in EMEs.

5.2.5. Economic growth rate and stock market liquidity

The associations between economic growth and the stock market in general and SML in specific are explained from the hypotheses, namely the “supply-leading” (Schumpeter, 1911) and the “demand-following” (Robinson, 1952; Kuznets, 1955) in literature. In the “supply-leading” hypothesis (or finance-growth hypothesis), Schumpeter (1911) claimed

that financial development causes economic growth. This “supply-leading” hypothesis is based on the view that the liberalised financial markets with the neoclassical economic approach have an accelerating influence on economic growth by encouraging savings on the one hand and efficient allocation of savings on the other. The “supply-leading” hypothesis assumed that financial development has a positive effect on economic growth, and it was supported later by some research. In the “demand-following” hypothesis (or growth-led hypothesis), Robinson (1952) argued that “where venture drives, finance follows” and revealed the necessity of high economic growth that creates demand in the financial sector. Improvements in the real sector drive higher demand for the use of money, consequently enhancing financial development. Besides two specific hypotheses, there are two other views on economic growth and financial development causality. The first is the “feedback” hypothesis, which is claimed that economic growth and stock markets can enhance each other and involve a mutual causality. According to this hypothesis, a country with a well-developed financial system could promote high economic expansion through technological changes and product and service innovation. The second is the “neutral” hypothesis, which states no causal relationship between financial development and economic growth. The causal association between financial development and economic growth depends on the stage of economic development. The “supply-leading” view can stimulate the actual capital formation and cause an increase in economic growth in the early stages of economic development. The “supply-leading” view becomes less critical as financial and economic development proceeds, and gradually the “demand-leading” view starts to dominate (Patrick, 1966).

It is generally documented that SML (e.g. stock market development) leads to economic growth in the theoretical and empirical literature with a positive effect (e.g. Zalgiryte et al., 2014; Pradhan et al., 2015; Al Rasasi et al., 2019; Grbić, 2021; Thaddeus et al., 2022; etc.). In contrast, some studies show an adverse effect in this “supply-leading” hypothesis (e.g. Iheanacho, 2016; Nyanaro & Elly, 2017; Pan & Mishra, 2018; etc.). Supporting the “demand-following” approach, several studies revealed that economic growth affects SML with mainly a negative impact (e.g. Goswami & Jung, 1997; Tang et al., 2007; Pradhan et al., 2015; etc.), whereas a positive impact appears in some studies (e.g. El-Wassal, 2005; Vazakidis & Adamopoulos, 2009; etc.). Besides, some studies detected a bi-directional causality between economic growth and SML, concurring with the “feedback” hypothesis (e.g. Wongbangpo & Sharma, 2002; Hondroyiannis et al., 2005; Apergis et al., 2007; Pan & Mishra, 2018; Ho, 2019; etc.) while no causal association existed concerning the “neutral” hypothesis (e.g. Binswanger, 2000, 2004; Mao & Wu, 2007; Tang et al., 2007; Rioja & Valev, 2014; etc.). Parallel to the causality research, the short- and long-run relationships between economic growth and SML have also been estimated with mixed findings in many studies. Numerous research suggests that SML is correlated to economic growth in the long time (e.g. Wongbangpo & Sharma, 2002; Van Nieuwerburgh et al., 2006; Davis et al., 2010; Österholm, 2016; etc.) or in the short time (e.g. Kamat & Kamat, 2011; Pradhan et al., 2015; Grbić, 2021; etc.) or in both short and long time (e.g. Jefferis & Okeahalam, 2000; Van Nieuwerburgh et al., 2006; Al Rasasi et al., 2019; Chancharat et al., 2022; Thaddeus et al., 2022; etc.) (See Figure 5.2. in APPENDIX 5.A)

H5: There exists a significant causal relationship between economic growth rate and stock market liquidity in EMEs.

5.2.6. Inflation rate and stock market liquidity

The literature has presented evidence that the relationship between inflation and SML (e.g. stock price, stock return, stock index) is highly controversial, including their causality and short- and long-run linkage. Although many hypotheses have been advanced to explain the association between them in the theoretical literature, they mainly argue for two correlations: positive and negative.

The positive relationship between inflation and stock returns was first defined in the economic theory of the Fisher hypothesis or “Fisher effect” (Fisher, 1930), proposing that stock returns provide a good hedge against inflation. The “wealth effect” hypothesis (Ando & Modigliani, 1963) could also explain the positive connection since real stock returns can influence inflation rates via their effect on consumption and, thus, aggregate demand. In contrast, several alternative theories have extensively explained the negative relationship between inflation and stock returns. More specifically, these alternative theories include the Nobel lecture on Inflation and Unemployment (Friedman, 1977), the “Money Illusion” hypothesis (Modigliani & Cohn, 1979), the “Tax Effect” hypothesis (Feldstein, 1980), the “Proxy Effect” hypothesis (Fama, 1981b), the “Reverse Causality” hypothesis (Geske & Roll, 1983). Many theories explain the relationship between stock returns and inflation rates with various empirical implications. Policy implications will also differ depending on the theory employed to explain the connection between these two variables.

The empirical literature on these hypotheses has been mixed and primarily inconclusive regarding the causality direction. The hypothetical explanations are inconsistent in different studies. Several studies concur with the Fisher hypothesis with a positive relationship. Interestingly, most

empirical studies reject the Fisher hypothesis in the shorter period, whereas the findings are more likely to encourage the Fisher hypothesis as the period increases. Most empirical evidence rejects a positive relationship (mainly the Fisher hypothesis) and validates a negative one (mainly the Proxy hypothesis). The outcomes of Alexakis et al. (1996) assert that inflation uncertainty seems to affect financial aggregates only in emerging capital markets. Numerous research has argued that the inflation rate negatively impacts most emerging capital markets. Besides the causality from inflation to SML, a reverse causality flowing from SML to inflation is documented in some research (e.g. Ioannides, 2005; (Bhattarai & Joshi, 2009; etc.). Moreover, a feedback relationship between inflation and SML is detected in a few studies (e.g. Wongbangpo & Sharma, 2002). Most causal correlations between inflation and SML are investigated in the context of the short and long run (e.g. Anari & Kolari, 2001; Arjoon et al., 2012; Adusei, 2014; etc.). It is noted that the long-run relationship between inflation and the stock market is inconsistent in EMEs. Some studies have presumed the long-term positive correlation between these variables in EMEs, while others have disclosed the negative association in the long run, concurring with Fama's proxy hypothesis. Several studies indicate the sign and strength of the association between inflation and stock returns depending on the frequency scale (e.g. Kim & In, 2005; Tiwari et al., 2015; etc.). Others show the associations evolving heterogeneously over time (e.g. Valcarcel, 2012; Antonakakis et al., 2017; etc.). However, some studies do not find any correlations between inflation and stock returns, even their causality. (See Figure 5.3. in APPENDIX 5.A)

H6: There exists a significant causal relationship between inflation rate and stock market liquidity in EMEs.

5.2.7. The Treasury bill rate and stock market liquidity

The interest rate environment has been considered an essential contribution to the stock market performance. Periods of interest rate decrease have generally been more favourable for stocks than periods of interest rate increase. There are many different interest rates within the economy, and Darrat & Dickens (1999) noted that interest rates lead to stock returns. The Treasury bill rate (risk-free rate) is generally recognised as a representative money market rate and a standard measure of interest rate with the lowest rate within the economy.

The real interest rate is defined within the context of no uncertainty and no inflation. To ascertain this rate, reference is usually made to Treasury bills, regarded as a risk-free asset; the returns typically lag behind risky investments such as equities. The difference between the returns on risk-free assets and risky assets is the risk premium, compensating investors for the risk taken. Thus, a risk-averse investor will always opt for T-bills rather than private securities whenever T-bills offer higher returns. In other words, a “flight to safety” caused by concerns about default or liquidity risk in other financial markets may make investors alter to T-bills to avoid risk (Federal Reserve Bank of San Francisco, 2005).

As an interest rate measure, the Treasury bill rate has similar effects as the interest rate on SML (e.g. stock price, stock return, and stock index) in the market, containing their causality and their short- and long-term effects. Most research evaluating the causal linkage between the Treasury bill rate and SML has been conducted in one way or another in developing and emerging countries. More specifically, a negative correlation between the Treasury bill rate and SML moving from the Treasury bill rate to SML has been disclosed in the most empirical literature (e.g. Adam & Tweneboah, 2011; Indangasi, 2017; Gurung, 2020; Koskei, 2021; etc.). By contrast,

some research obtains a positive relationship between T-bill rate and SML (e.g. Mutuku & Ng'eny, 2014; Babangida & Khan, 2021; etc.). In line with the causality studies, the relationship between T-bill rate and SML in the short and long run has been conceded even though it is not significant in some research (e.g. Adam & Tweneboah, 2011; Addo & Sunzuoye, 2013; Abdelmonem & Mohamed, 2018; Sinha et al., 2021; etc.). Interestingly, among the studies, some obtain unusual findings. For example, Issahaku et al. (2013) discovered a significant correlation between stock returns and the Treasury bill rate in the short run, whereas no connection exists in the long run. The authors also obtained a causal relationship moving from stock returns to the Treasury bill rate in Ghana from 1995 to 2010. Gurung (2020) reported a negative bi-directional causality between the Treasury bill rate and stock index in Nepal in the long term from 1994 to 2018 by applying the ECM with the annual time series data, but their short-term causality was not supported. (See Figure 5.3. in APPENDIX 5.A)

H7: There exists a significant causal relationship between the Treasury bill rate and stock market liquidity in EMEs.

5.3. DATA AND METHODOLOGY

Stage 1: Data description

Data for parameters estimation and the model specification were mainly sourced from three databases: Bloomberg, the World Bank's World Development Indicators database, and stock exchange websites. The panel data used in this study consisted of seven cross-sections in EMEs, namely China, India, Mexico, Russia, Indonesia, Turkey and Poland, in 19 years spanning from 2000 to 2018.

Stage 2: Model specification

This study followed a dynamic model approach via the CS-ECM strategy to evaluate the long-term equilibrium relationship between MOP and SML in EMEs. Based on extensive previous literature, the study initially considered the explained variables of SML and the explanatory variables of MOP utilised in many studies to formulate a general model. Statistically nonsignificant or unintegrated specifications were then removed, and finally, the general model specification was expressed as follows.

$$SML = f(MOP, MAC, FIG)$$

$$SML_{it} = \alpha_{it} + MOP'_{it} \beta + MAC_{it} \beta + FIG_{it} \beta + u_{it} \quad (5.1)$$

where α_{it} : the intercept.

β : the slopes of the respective explanatory variables (MOP variables) and control variables (MAC and FIG).

u_{it} : the error term accounts for the un-modellable influencing factors in the panel framework.

Stage 3: Variable selection and calculation

The measurement of stock market liquidity:

Several widely accepted liquidity measures address the mentioned research hypotheses based on financial system characteristics (Martin et al., 2012) and indicators of liquidity dimensions (Kyle, 1985; Harris, 1990; Sarr & Lybek, 2002; Wyss, 2004; Kutas & Végh, 2005; Váradi, 2012; Octavio et al., 2013; PwC, 2015). In this study, five different measures, consisting of Resiliency, Depth, Tightness, Immediacy and Diversity, were opted to represent the SML characteristics. Besides, SML measures were assessed by yearly data in this study. The detailed description of SML measures conducted in this study is shown in Table 2.1, and in APPENDIX 2.A.

The measurement of monetary policy:

In line with previous literature, to investigate the impact of MOP on SML for this study, the author identified several MOP variables that could capture the overview of MOP's influence. First, for the MOP's transmission mechanism, the real interest rate, money base, and the exchange rate were used to research. Second, for the ultimate objectives of a Central Bank, the author utilised the real economic growth rate and inflation rate. Third, the Treasury bill rate was also opted as a proxy for the interest rate of money market instruments, an alternative to stocks and possibly capturing the opportunity cost of investment in the capital market. The detailed description of MOP measures adopted in this study is presented in Table 2.1, and in APPENDIX 2.B.

The measurement of control variables:

Market capitalisation is the value of the total shares outstanding in the capital market following the stock's closing price (Silviyani et al., 2016). The greater market capitalisation will provide a positive signal that the outstanding stock's price is also high so that it is the potential to make high returns to investors (Menaje, 2012).

Globalisation in general and financial globalisation in particular has a meaningful effect on the financial market growth and development, having noted that financial globalisation caused the integration of domestic stock markets into other developed stock markets worldwide. As observed from the previous literature, globalisation or internationalisation of the stock market increases listing, capital raising and trading abroad in the domestic market (Oluwole, 2014).

A detailed description of measures of the control variables used in this study is presented in Table 2.1.

Stage 4: Analysis strategy

This study conducted the CS-ECM analysis strategy: identifying the properties of variables (stationarity, cross-sectional dependence and cointegration relationship), analysing the Granger causal relationship, and estimating the CS-ECM, which permits to analyse of the long-run relationship between the variables jointly with the short-term adjustment towards the long-run equilibrium. The optimal lag lengths in the study were opted for by using BIC. (See APPENDIX 5.B)

Stationarity test (Panel unit root test - PURT):

The stationary of the series is essential to performing the causality and CS-ECM analyses; thus, the stationary of the series firstly will be examined. To prove the robustness of unit root tests for panel data, the author conducted tests on each panel classified into two types: “first generation tests” assuming cross-sectional independence and “second generation tests” allowing cross-section dependence (e.g. Baltagi, 2005; Breitung & Pesaran, 2008).

Cross-sectional dependence test:

When investigating panel data Granger causality tests across countries, cross-sectional dependence is a significant issue to be faced due to globalisation across the world in general and financial integration in specific. The increasing financial integration between countries can cause shock in one country and significantly affect other countries if cross-sectional dependence exists. The Breusch-Pagan Lagrange multiplier test (Breusch & Pagan, 1980) and Pesaran’s cross-sectional dependence test (Pesaran, 2004) were used for testing cross-sectional dependency in this study.

Panel cointegration test:

The cointegration analysis is based on the idea that some linear combinations of non-stationary series may be stationary. Said differently, there may be equilibrium relations between them in the long run. The slope coefficients vector stabilises; this combination is called the cointegrating vector (Pedroni, 1999). This study used residual-based tests to present the testing statistics of the panel cointegration relationship among variables. The Kao test (Kao, 1999) examines the cross-sectional cointegration vectors in the homogeneity case, while the Pedroni test (Pedroni, 1999, 2004) allows for heterogeneity under the alternative hypothesis. Besides, the Westerlund test (Westerlund, 2007) uses yet another approach that imposes fewer restrictions.

Granger causality test:

Cointegration analyses do not provide information on the direction of causality. Therefore, causality analysis should be undertaken to determine causal relationships between the series. Among different causality methods, the author employed the Granger causality test for panel data suggested by Dumitrescu & Hurlin (2012). The noticeable strength of this causality technique is that dealing with the issue of cross-sectional dependence is conducted by a bootstrap procedure. The lag selection is based on BIC on an automatic lag selection method basis.

CS-ECM estimation:

Dynamic models support the estimation of long-run associations. They measure the impact of an explanatory variable on the steady-state value of the explained variable. Accordingly, the CS-ECM model approach is a framework for cross-sectional heterogeneity and treats all variables as endogenous within the equation system. Besides, this model is set up due

to the presence of non-stationary but cointegrated data forms. After the cointegration was known, the following test process was done using the error correction method. Kremers et al. (1992) revealed that the ECM is usually more powerful and gives more efficient results as a cointegration relationship exists. Eberhardt & Presbitero (2015) also conceded that implementing the ECM in macro panels brings significant advantages over static models and restricted dynamic specifications.

5.4. EMPIRICAL ANALYSIS AND DISCUSSIONS

5.4.1. Descriptive analysis

The graphs from Figure 5.4 (see APPENDIX 5.C) visually provide an overall picture describing the relationship between MOP and SML in EMEs from 2000 to 2018. It can be seen clearly from the graphs that the implementation of MOP aspects generally does not have significant differences in each selected EMEs. Accordingly, changes in SML characteristics (such as ReM, DeM, TiM, ImM and DiM) revealed a similar trend. The goals guiding MOP in different countries are highly similar, while Central Banks diverge in their methods of policy implementation. MOP in EMEs is no exception. Generally, the correlation between MOP and SML was quite similar in EMEs from 2000 to 2018, except for Turkey. It is noticeable that MOP implementation and response to the stock market of Turkey seem different from other selected EMEs. It explains for differences in the characteristics of DeM and TiM in Turkey during the research time. There is no consistent and harmonious pattern between MOP and SML adopted for all EMEs, but it seems changes aiming to primary goals eventually in EMEs.

5.4.2. Stationarity test

- First-generation panel unit root test:

The first-generation panel unit root tests are based on the assumption that the cross-section units are cross-sectionally independent. The tests' null hypothesis is that the series has a unit root, i.e., non-stationary, while the alternate hypothesis is that the series is stationary except for the Hadri test with the null hypothesis of stationarity. For the cointegration test, the series must be non-stationary at a level while it should be stationary at first difference. The significance level considered here is 1%, 5% and 10%.

SML and control variables, four-panel unit root tests (Breitung, LLC, IPS and Hadri) were implemented to infer on nonstationarity of panel data for MOP. The results from the first-generation panel unit root tests were subject to the inclusion and exclusion of a time trend, and the optimal lag lengths were chosen using BIC. Table 5.2 (see APPENDIX 5.D) presents the mixed results of first-generation panel unit root tests for all variables with the rejection and acceptance of the null hypothesis of the presence of a unit root at the 1%, 5% and 10% levels.

More specifically, as presented in Table 5.2, the Breitung test rejected the null hypothesis of a unit root for the MEC, LogSrellog, GDP_r and FIG at the 1% and 5% level with time trend and without time trend and only for MB and LnMAC at the 10% level of significance when a time trend was included in the estimation. The LLC test rejected the null hypothesis of a unit root for all SML variables (except LnV), all MOP variables (except LnEXR) and control variables at 1% and 5% significance levels when a time trend was not included in the estimation. It also rejected the null hypothesis of a unit root in the panel of all SML and MOP variables (except LnQ, LogSrellog, LnHHI and LnEXR) and control variables from 1% to 10% significance level when a time trend was included. The IPS

test results explained that the SML, MOP and control variables are stationary from 1% to 10% level of significance when the time trend was included and excluded in the analysis except for LNQ LnV and LnTBR oppositely changed stationary state. All the above tests took as the null hypothesis that the series contains a unit root. The Hadri test was also employed to test the null hypothesis that the data are stationary and the alternative that at least one panel contains a unit root. The test is designed for cases with large T and moderate N, appropriate for this research sample. The Hadri test rejected the null hypothesis of stationarity in the panel of all SML, MOP and control variables except MEC and LogSrellog had opposite changes in a stationary state.

In short, based on the results of these first-generation panel unit root tests, the author can generalise that the panel of SML, MOP and control variables is non-stationary.

- Second-generation panel unit root test:

When there is a correlation between the units, choosing “the second-generation panel unit root test” is necessary. For this reason, it is decided to utilise the “Pesaran CADF Test” for stationary analysis. In other words, the author conducted Pesaran’s cross-sectional augmented Dickey-Fuller (CADF) test in order to supplement the robustness of the first-generation test. The first generation of panel unit root tests is criticised for assuming cross-sectional independence, an assumption relaxed under the second generation of panel unit root tests. In this case, the full battery of second-generation tests indicates that the SML, MOP and control variables were non-stationary, except INRr and LnEXR were stationary without a time trend at significance levels of 5% and 1%, and Lnn was stationary with a time trend at 5% level (see Table 5.3 in APPENDIX 5.D). The “non-

stationary” state of the first-generation test (the Hadri test) was supported by these results.

All in all, the CADF test accepted the null hypothesis of “all series are non-stationary” at the 5 per cent significance level, encouraging the results attained by the first-generation panel unit root tests above. That is to say, the panel of all research variables is non-stationary.

5.4.3. Cross-sectional dependence test

Based on the opted and collected sample, the Breusch-Pagan Lagrange Multiplier (Breusch-Pagan LM) test of independence was conducted to evaluate the correlation matrix of residuals. The H₀ hypothesis, “Homoscedasticity is present (the residuals are distributed with equal variance)”, was tested. The outcomes of the LM test had p-values < .05. It rejected the null hypothesis for any confidence level, so the errors exhibited cross-sectional correlation (see Table 5.4 in APPENDIX 5.E).

Besides the Breusch-Pagan LM test, the CD test statistic (Pesaran, 2004) with the H₀ hypothesis representing “there is no correlation between the units” was employed (see Table 5.5 in APPENDIX 5.E). As we can see from the p-values lower than 1%, 5% and 10%, the CD tests of most estimations moderately or strongly rejected the null hypothesis, except for the estimations of the LnQ, LnN and Lnn. However, the CD test’s possible weakness that counts up positive and negative associations may cause failure to reject the null hypothesis even if there is plenty of cross-sectional dependence in the errors. Here the average absolute correlation of estimations was from 0.252 to 0.424, which are high values. As a result, it was induced that there is a correlation between the units.

Therefore, it is enough evidence to suggest the presence of cross-sectional independence in each estimation.

5.4.4. Panel cointegration test

Performing a cointegration test is conditioned on a variable having at least a unit root, and the condition almost meets. After confirming the presence of unit root for all research variables, a panel cointegration test was employed to reveal the relationship between the series in the long term. The result from the cointegration test will determine the existence of long-run relationships among the variables in the model. All tests of Kao (1999), Pedroni (1999, 2004) and Westerlund (2007) have a null hypothesis of no cointegration, but the alternative hypotheses are different. More specifically, the alternative hypotheses of the Kao and Pedroni tests are that “All panels are cointegrated”. Unlike the Kao and Pedroni tests, two different versions of the alternative hypothesis were proposed in the Westerlund test, including “All panels are cointegrated” and “Some panels are cointegrated”.

To investigate the existence of a long-term relationship between MOP and SML series, the author considered the seven cointegration tests proposed by the tests of Pedroni (1999, 2004) and Kao (1999). All these tests were based on the null hypothesis of no cointegration.

For the Kao panel-data cointegration test, most results of Kao’s test strongly rejected the null hypothesis, indicating a cointegrating relationship between the observed variables (see Table 5.6 in APPENDIX 5.F). Based on these residual cointegration tests, it can deduce the long-run correlations between MOP and SML variables.

For the Pedroni panel-data cointegration test: the results of the Pedroni’s tests in Table 5.6 (see APPENDIX 5.F) are divided into two parts. The first part’s alternative hypothesis, as mentioned, assumes that the coefficients of the lagged autoregressive residual across individual units are identical, whereas this assumption is relaxed in the second part. It is

evident in Table 5.6 that when an only intercept was included, almost Pedroni's statistics rejected the null hypothesis to confirm the non-stationarity of panel data either at 1% or 5% or 10% level of significance. Similarly, most of the Pedroni test statistics supported the favour of cointegration when intercept and trend were included. Thus, the Pedroni test statistics provided evidence of the long-run equilibrium relationships among variables.

Besides, the author chose the Westerlund panel cointegration test with the assumption relaxed: the alternative hypothesis of "Some panels are cointegrated". In Table 5.6 (see APPENDIX 5.F), most of the Group-mean VR and Panel VR statistics, which are commonly used as the criterion for the null hypothesis of no cointegration, were significant with p-values of 1%, 5% and 10%, except MEC, LogSrellog and LnHHI. As such, we could conclude that a long-run relationship exists.

On the whole, the given results almost confirm the long-run relationship between MOP and SML.

5.4.5. Granger causality test

The existence of cointegration confirmed long-run relationships between different variables of models. Subsequently, the author tried to determine the direction of causality among them by applying the Granger causality approach of Dumitrescu & Hurlin (2012). Accordingly, the pairwise Granger causality results of the DH test for each model are estimated and presented in Table 5.7 (see APPENDIX 5.G). The Granger causality test results showed significant differences in the causal association between MOP and SML across the different SML characteristics. These differences are witnessed in the results, which indicate the significance of the stock market in establishing the dynamic linkages of financial markets and macroeconomic policies, especially MOP. These Granger test results

also reveal causal connections between LnMAC, FIG and SML characteristics in the same contexts. The results were reported for lag augmentations of the BIC from 1 to 4 (inclusive).

Market resiliency:

In the model of MEC (MEC as an explained variable), there was only a significant one-way causal link running from MB to MEC for at least one stock market at a 5% level, whereas MEC had a slight reverse causality with CPI and LnTBR at 10% level. Besides, FIG did a significant positive Granger-cause MEC at 5%. The results indicate that the positive unidirectional correlation between MB and ReM (via MEC) strongly supports the “real activity” theory with the view that “money supply increases, then stock prices increase”, which was conceded by Bernanke & Kuttner (2005). The financial globalisation phenomenon (especially financial integration) considerably affects ReM. ReM lightly influences CPI in the reverse correlation, following the “Fisher effect” hypothesis (Fisher, 1930) and influences LnTBR, not concurring with the traditional view of the nexus of interest rate-stock prices. *For Market resiliency*, there are three unidirectional relationships, one where Monetary aggregates affects Market resiliency (via MEC), and two where Market resiliency affects Inflation rate and the Treasury rate.

Market depth:

In the model of LnQ (LnQ as an explained variable), only one-way causality from MB to LnQ significantly positively existed, confirming the “real activity” theory. *In the model of LnV (LnV as an explained variable)*, unidirectional Granger causality moved from CPI and MB to LnV with the significance level at 1% and 5%, respectively. LnMAC also had a highly significant Granger cause with LnV at 1%. That is to say, based on the models of LnQ and LnV, the positive directional linkage

flowing from MB to DeM (via LnQ and LnV) dramatically concurs with the “real activity” theory. Furthermore, CPI had a positive, enormously significant impact on DeM through LnV variable, which agrees with Fisher’s hypothesis. In addition, LnMAC strongly and remarkably influenced DeM (via LnV), which could become one of the investors’ concerns in their investment strategy. *For the Market depth*, two one-way causalities exist, running from Monetary aggregates and Inflation rate to Market depth (via LnQ and LnV).

Market tightness:

In the model of LogSrellog (LogSrellog as an explained variable), four variables of MOP, namely INRr, GDPPr, CPI and LnTBR, had a slight directional causality with LogSrellog at a statistical level of 10%. Interestingly, LnMAC showed a highly significant bilateral relationship with LogSrellog at 1%, while FIG strongly did one-way Granger-cause LogSrellog at the same statistical level. *In the model of LnSeff* (LnSeff as an explained variable), surprisingly, LnSeff had a reverse relationship with most MOP variables such as LnEXR, MB, GDPPr and LnTBR at 1%, 5%, 5% and 5%, respectively. In contrast, there was only a highly significant directional causality from CPI to LnSeff at 1%. Both LnMAC and FIG were positively correlated with LnSeff with different significance levels. The outcomes shown from the models of LogSrellog and LnSeff explained that INRr and LnTBR slightly positively affect TiM (via LogSrellog), not based on the traditional viewpoint of “a negative relationship”. Interestingly, GDPPr had a positive bilateral causality with TiM (via LogSrellog and LnSeff), encouraging the “feedback” hypothesis obtained by Wongbangpo & Sharma (2002), Hondroyiannis et al. (2005), Apergis et al. (2007), Pan & Mishra (2018), Ho (2019), etc. Aligning with the Fisher hypothesis, CPI positively affected TiM with different

significances through LogSrellog and LnSeff variables. LnMAC was identified as a bi-directional correlation with TiM (via LogSrellog and LnSeff), while FIG had only a unidirectional correlation with TiM moving from FIG to TiM. Under this circumstance, LnMAC would be one of the impactful factors determining the investors' decisions and strategies in the stock market because MAC is known as a tool for understanding a stock's risk. It can be seen clearly that TiM also had a reverse connection with some MOP variables. To illustrate, changes in TiM positively considerably impacted MB in capital markets in specific and in the economy in general, which is validated by the "wealth effect" (Friedman, 1988). TiM also had a highly significant positive effect on LnEXR in the economy, which is asserted by the flow-oriented model of Dornbusch & Fischer (1980). In addition, an increase in TiM led to a significant increase in LnTBR, which is opposite to the traditional view of the interest literature. *For Market tightness*, there are four directional associations, two where Interest rate and Inflation rate impact Market tightness (via LogSrellog and LnSeff), and two where Monetary aggregates and the Exchange rate are affected by Market tightness (via LnSeff). In this characteristic, two bi-directional relationships are revealed between the Economic growth rate and Market tightness (via LogSrellog and LnSeff) and between the Treasury bill rate and Market tightness.

Market immediacy:

In the model of LnN (LnN as an explained variable), only MB slightly did Granger-cause LnN at 10% while LnN had a reverse correlation with INRr and CPI with the statistical level of 1% and 10%, respectively. LnMAC had a significant directional causal link with LnN running from LnMAC to LnN at 5%, whereas LnN did Granger-cause FIG at the same significance level. *In the model of Lnn (Lnn as explained variable)*, the results were

very similar in causality direction to the model of LnN, except MB became more significant at the statistical level of 5%. The results revealed that the related variables' causality has the same direction and significance level in both models of LnN and Lnn. To clarify, MB and ImM had a slight positive one-way association running from MB and ImM following the “real activity” theory. In the reverse linkage, ImM significantly influenced INRr, which does not support the traditional view of the interest rate literature. Concurred with the Fisher hypothesis, ImM also impacted CPI slightly positively. Interestingly, LnMAC had a significant positive directional connection with ImM, whereas FIG had a significant positive reverse effect with ImM moving from ImM to FIG. *For Market immediacy*, there are three unidirectional correlations where Monetary aggregates influence Market immediacy (via LnN and Lnn), where Market immediacy influences Interest rate and Inflation rate.

Market diversity:

In the model of LnHHI (LnHHI as an explained variable), unexpectedly, there were three positive bi-directional relationships between LnTBR, GDPPr, LnMAC and LnHHI with a high statistical level. LnTBR and GDPPr had a significant directional relationship with LnHHI flowing from LnTBR and GDPPr to LnHHI at 1% and 5%, respectively. However, their significance levels were converted in the reverse association. LnMAC became strongly significant in the correlation running from LnMAC to LnHHI at 1%. These findings indicate that the significant positive two-way causality between GDPPr and DiM (via LnHHI) encourages the “feedback” hypothesis. The positive dual causal correlation between LnTBR and DiM (via LnHHI) does not strongly concede the “negative sign” of the interest rate literature. In the reverse association, DiM slightly positively impacted INRr, which is the opposite of the traditional interest

rate view. DiM also significantly positively affected MB following the “wealth effect”. Besides, DiM had a slightly positive influence on LnEXR, confirming the “stock-oriented” model. Likewise, with the characteristic of TiM, LnMAC would be an investor’s concern for their investment with its two-way relationship. *For Market diversity*, two bilateral relationships of causality exist between the Economic growth rate and Market diversity (via LnHHI) and between the Treasury bill rate and Market diversity. In this characteristic, three other unidirectional relationships move from Market diversity to Interest rate, Monetary aggregates and the Exchange rate.

There were two directional associations: Market capitalisation affects Market depth (via LnV) and Market immediacy (via LnN and Lnn). In contrast, two bi-directional associations were detected between Market capitalisation and Market tightness (via LogSrellog and LnSeff) and between Market capitalisation and Market diversity (via LnHHI). Unlike Market capitalisation, there were four unidirectional relationships between Financial globalisation and SML, two where Financial globalisation impacts on Market resiliency (via MEC) and Market tightness (via LogSrellog and LnSeff), and two where Financial globalisation was affected by Market immediacy (via LnN and Lnn) and Market diversity (via LnHHI).

The other connections between MOP, control variables (LnMAC and FIG) and SML characteristics were acceptance of the Null hypothesis and, consequently, the rejection of the alternative hypothesis (see Table 5.7 in APPENDIX 5.G). Said differently, the rest of the Causality test results did not detect any direction of causality between the series.

In essence, *the Granger causality results indicate the presence of the causal relationship between MOP and SML in EMEs, except for the Exchange rate running from SML to the Exchange rate. All identified*

unidirectional and bi-directional causalities between research variables (especially MOP and SML) have a positive sign with the trend from 1 to 4-period lags even though their significance levels are different. Although most of the results tend to be dynamic in nature and support the existence of research literature (see Figure 5.5 in APPENDIX 5.G), the direction of causality between MOP and SML is still mixed and ambiguous. Such results partly reflect the interactive relationship between SML and factors considered as determinants like MOP, Market capitalisation and Financial globalisation, even with various significance levels. Accordingly, it has posed a challenge to how specific policies of MOP promoting the financial system interact with the decisions of economic agents at the micro-level and vice versa. In other words, it is necessary to specify a framework for each country and each related stock market.

5.4.6. CS-ECM estimation

The dynamic panel model approach can identify sources of causation and can distinguish between a short- and long-term relationship in the series. After ensuring the long-term equilibrium operationally by cointegration, the dynamics of SML were subsequently defined in the CS-ECM approach, and all coefficients were assumed to be heterogeneous. The CS-ECM is designed to capture the short-run deviations that might have occurred in estimating the long-run co-integrating equation. Following Lütkepohl (1993) and Chudik & Pesaran (2015), the number of lags p is called the order or lag length of the autoregression: $p = \left\lceil T^{\frac{1}{3}} \right\rceil = \left\lceil 19^{\frac{1}{3}} \right\rceil = 2$ lags of the cross-sectional averages were added, i.e. the autoregressive distributed lag technique was used with a maximum lag length of 2 in this study. Standard errors and confidence intervals can be obtained by a

simple bootstrap in which the cross-sectional units are drawn with replacement. A bootstrap with 100 repetitions was automatically run.

Market resiliency:

In the model of MEC (see Table 5.8 in APPENDIX 5.H): The CD tests rejected the null hypothesis of (semi-) weak cross-sectional dependence for three variables of GDP_r, CPI and LnEXR at the statistic level of 5%, 10%, except INR_r, MB and LNTBR. Bailey et al. (2019) stated that the estimated exponent of cross-sectional dependence should be close to 0.5 if the residuals are weakly cross-sectional dependent. The estimated exponents of cross-sectional dependence were well above 0.6. An estimation method taking the strength of the factors for cross-sectional dependence into account is necessary. The CS-ECM's estimation results show that most MOP variables are statistically nonsignificant to MEC in the short run. Only the short-run coefficient of GDP_r (-0.2188) was negative and slightly significant at 10%. A decrease in GDP_r will increase MEC in the short term. Noticeably, FIG also had a slight impact on MEC in the short period; however, this impact happened relating to the presence of MB, LnEXR, and GDP_r. The adjustment coefficients of MEC imply that the percentages of the disequilibrium are adjusted every period. As such, the partial adjustment to the long-run equilibrium appeared to be quick; more than 75% of the gap was closed within one period (one year). The long-run effects of all MOP variables on MEC are nonsignificant even though INR_r, MB and GDP_r have changes in their signs in the long run. Both LnMAC and FIG influenced MEC which concerns the existence of GDP_r and LnEXR with statistical significance at 5% and 10%, respectively. *For brevity, for the characteristic of Market resiliency, the finding that "Economic growth rate slightly negatively affects SML in the short run through the characteristic of Market resiliency" is consistent*

with those of Robinson (1952), Chen et al. (1986), Goswami & Jung (1997) and others, but in the long term, the impacts of all MOP variables are nonsignificant.

Market depth:

In the model of LnQ (see Table 5.9 in APPENDIX 5.H): The CD tests only rejected the null of weak cross-sectional dependence for two variables of LnEXR and MB at the 10% level. The estimated exponents of cross-sectional dependence were strong, with above 0.5. The CS-ECM's estimation results of LnQ state that all MOP variables are nonsignificant to LnQ in the short term. Nevertheless, FIG still significantly impacted LnQ through the presence of LnEXR and MB at the 1% level and 5% level, respectively. The mean group estimate of the partial adjustment coefficients of the LnQ estimations was still moderate (more than 52%). However, the long-term disequilibrium, adjusted every year, only related to GDP_r, LnTBR and INR_r in the long term, with statistical significance at 1% and 10% levels. Like the short-run effects, the long-run effects of MOP variables on LnQ were nonsignificant and LnTBR merely changed its direction in the long run. Only LnMAC had a slight effect on LnQ via the existence of CPI in the long run. *In the model of LnV* (see Table 5.10 in APPENDIX 5.H): The CD tests rejected the null of weak cross-sectional dependence for three variables of INR_r, CPI and GDP_r at the 1% and 10% levels, and the estimated exponents of cross-sectional dependence were strong with more than or equal 0.5. The CS-ECM's estimation results of LnV indicate that only MB is negative (-0.0123) and significant to LnV at a statistical 5% level in the short term. A fall in MB will rise LnV in the short period. There was only a slight long-run impact of MB on LnQ and a change in its sign. The partial adjustment to the long-run equilibrium appeared to be very fast; more

than 80% of the gap was adjusted within one year. *In short, for the characteristic of Market depth, the outcome that “Monetary aggregates significantly negatively affect SML in the short time through the characteristic of Market depth concedes the consistency of the results of Keynesian views (e.g. Širuček, 2013; Jonathan & Oghenebrume, 2017), while another outcome that “Monetary aggregates slightly positively affect SML in the long time” concurs with the statement of real activity theorists and is disclosed by (e.g. Bulmash & Trivoli, 1991; (Pícha, 2017); etc.). An increase in Monetary aggregates, other things equal, decreases interest rates and stimulates the economy, and vice versa.*

Market tightness:

In the model of LogSrellog (see Table 5.11 in APPENDIX 5.H): The CD tests only rejected the null of weak cross-sectional dependence for two variables of MB and LnEXR at the 5% and 10% levels. The estimated exponents of cross-sectional dependence were strong with the above 0.5. The CS-ECM’s estimation results of LogSrellog illustrate that only LnTBR is strongly significant to LogSrellog, with a statistical level of 1% in the short term. The short-run effect of LnTBR on LogSrellog was 1.5324, which means an increase in LnTBR will increase LogSrellog in the short run. Surprisingly, both LnMAC and FIG affected LogSrellog relating to the existence of LnTBR and LnEXR in the short term with the statistical level of 5% and 10%, respectively. The partial adjustment to the long-run equilibrium appeared relatively quick; more than 68% of the gap was closed within one year. Only MB had a significant negative long-run impact on LogSrellog with a 5% level of statistical significance. A one per cent decrease in MB will lead to an increase of LogSrellog of 0.0696%. Although MOP variables were mainly nonsignificant to LogSrellog in the long term, most changed their directions, except MB

and CPI. *In the model of LnSeff* (see Table 5.12 in APPENDIX 5.H): The CD tests only rejected the null of weak cross-sectional dependence for two variables of LnTBR and INRr at the 1% and 10% level, and the estimated exponents of cross-sectional dependence were strong with the above 0.5. The CS-ECM's estimation results of LnSeff show that only INRr is slightly significant to LnSeff with a statistical level of 10% in the short term. A one per cent drop of INRr to LnSeff is associated with an increase of LnSeff of 0.0599%. FIG also slightly negatively influenced LnSeff at the 10% level. The partial adjustment to the long-run equilibrium concerning INRr, LnEXR and GDP_r appeared to be very fast; more than 80% of the disequilibrium was adjusted within one year, while it is relatively slow to the disequilibrium concerning MB and CPI. The partial adjustment to the long-run equilibrium relating to LnTBR was nonsignificant. Only CPI negatively impacted LnSeff at the 10% level in the long run. One per cent fall in CPI causes a rise in LnSeff of 0.1639%. Most MOP variables changed their signs over a long period, except INRr and LnTBR. *Concisely, for the characteristic of Market tightness*, the result that “*Interest rate fairly negatively impacts SML in the short term through the characteristic of Market tightness*” supports the classical interest rate theory (e.g. Franco Modigliani, 1971; Mishkin et al., 1977), whereas another result that “*the Treasury bill rate strongly significantly positively impacts SML in the short term*” does not assist this theory. These effects become nonsignificant in the long term. Nevertheless, “*in the long term, Monetary aggregates significantly negatively influence SML through the characteristic of Market tightness*” is consistent with those of Keynesian economists and “*Inflation rate slightly negatively influences SML in the long term*” encourages the Proxy Effect hypothesis (Fama, 1981b).

Market immediacy:

In the model of LnN (see Table 5.13 in APPENDIX 5.H): The CD tests rejected the null of weak cross-sectional dependence for three variables of INRr, LnEXR and LnTBR at the 10% level. The estimated exponents of cross-sectional dependence were strong with above 0.5. The CS-ECM's estimation results of LnN indicate that MOP variables are nonsignificant to LnN in the short term. In contrast, FIG had a significant impact on LnN with the existence of MB. Likewise the short-term effect, there is a nonsignificant influence of MOP on LnN in the long-term effect. The mean group estimate of the partial adjustment coefficients reflected that more than 50% of the long-run disequilibrium was adjusted every year, except the disequilibrium relating to CPI. Interestingly, both LnMAC and FIG significantly impacted LnN via the appearance of INRr simultaneously in the long run with a statistical level of 5%. Some MOP variables like MB, LnEXR and LnTBR had changes in their direction sign, while others did not change in the long term. *In the model of Lnn* (see Table 5.14 in APPENDIX 5.H): The CD tests only rejected the null of weak cross-sectional dependence for two variables of INRr, LnEXR at the 5% and 10% levels. The estimated exponents of cross-sectional dependence were strong with above 0.6. Likewise, with the model of LnN, the CS-ECM's estimation results of Lnn reveal that MOP variables are nonsignificant to Lnn in the short term. At the same time, FIG slightly affected Lnn relating to MB at the statistical level of 10%. The mean group estimate of the partial adjustment coefficients implied that more than 50% of the long-term disequilibrium was adjusted every year. Only CPI had a slightly negative influence on Lnn in the long run. A decrease in CPI will increase Lnn in the long run with 0.1023%. Most MOP variables had variations in their direction over the long period, except INRr and

GDP_r. *Succinctly, for the characteristic of Market immediacy, all MOP variables are nonsignificant to Market immediacy in the short and long periods. Only the finding that “Inflation rate slightly negatively influences SML in the long term through the characteristic of Market immediacy” concurs with the Proxy Effect hypothesis (Fama, 1981b).*

Market diversity:

In the model of LnHHI (see Table 5.15 in APPENDIX 5.H): The CD tests reject the null of weak cross-sectional dependence for three variables of MB, GDP_r and LnTBR at the 5% level, and the estimated exponents of cross-sectional dependence are strong with more than or equal to 0.5. The CS-ECM’s estimation results of LnHHI detect that all MOP variables are nonsignificant to LnHHI in the short term, even LnMAC and FIG. The mean group estimate of the partial adjustment coefficients implied that more than 50% of the long-run disequilibrium was generally adjusted every year, except the disequilibrium relating to MB and GDP_r. LnTBR and MB had a significant long-term influence on LnHHI at 5% and 10%, respectively, whereas FIG significantly impacted LnHHI through the presence of INR_r in the long term. Most MOP variables did not change their signs over a long period, except LnTBR. *Briefly, for the characteristic of Market diversity, there is a nonsignificant influence of all MOP variables on Market diversity in the short run. The outcome that “the Treasury bill rate significantly positively affects SML in the long run through the characteristic of Market diversity” does not support the traditional interest rate theory while “Monetary aggregates slightly negatively affect SML in the long run” asserts the consistency of Keynesian views.*

All things considered, *the results of the CS-ECM estimations disclose that the short- and long-run effects of MOP on SML in EMEs exist. The CS-ECM estimations capture the short-term deviations of research*

variables from equilibrium and their long-run movements with the consideration of two lags in the cross-sectional averages. All research variables in each model of MEC, LnQ, LnV, LogSrellog, LnSeff, LnN, Lnn and LnHHI are strongly cross-sectional dependent on the estimated exponents (α), which are more than or equal to 0.5. The CD-test statistic yields the same conclusion: most variables contain solid cross-sectional dependence.

Both Market capitalisation and Financial globalisation differently impact SML characteristics in the short and long term. It notes that Financial globalisation mostly has a short-term effect on SML characteristics (except the characteristic of Market diversity), while both Market capitalisation and Financial globalisation affect some SML characteristics in the long term.

5.5. CONCLUSIONS AND RECOMMENDATIONS

This study has attempted to examine the causal linkage between MOP and SML in seven selected countries of EMEs in the short and long run from 2000 to 2018 by applying a dynamic panel model approach. Market capitalisation and Financial globalisation were utilised as control variables. The author employed different tests and techniques: beginning with stationarity tests, then cross-sectional dependence tests, cointegration tests, the Granger causality tests, and the CS-ECM technique.

More specifically, starting with descriptive graphs about MOP and SML characteristics, the study provided an overview of the general connection trend between MOP and SML in EMEs from 2000 to 2018. Then, the tests for stationarity, including “first-generation and second-generation tests”, were employed to ensure the robustness of unit root tests for panel data. These panel unit root tests illustrated that most research variables under concern are not stationary at level. Next, the cross-sectional

dependence tests were also considered to examine the interdependence of related countries, and the outcomes presented evidence for the existence of cross-sectional independence. After that, the residual-based approach of the Kao, Pedroni and Westerlund tests for cointegration recommended that almost data series are cointegrated among themselves, having a strong long-term relationship. Precisely, the results of these tests approved the presence of cointegration associations between research variables, meaning that at least one long-run relationship between variables exists.

To deal with the problem of cross-sectional dependence, a test for the Granger causality of Dumitrescu & Hurlin (2012) was applied through the bootstrap approach. Interestingly, the findings of the DH test reveal that all identified unidirectional and bi-directional causality between MOP and SML variables in EMEs were simultaneously positive with the trend from 1 to 4-period lags, even both Market capitalisation and Financial globalisation. More specifically, the *Interest rate* has a positive one-way causality running from Interest rate to SML (i.e. Market tightness) and two positive reverse causalities with SML (i.e. Market Immediacy and Market diversity). These causalities have an important implication that not only the interest rate policy of Central Banks in the EMEs slightly influences the stock market performance (i.e. SML), but also the stock market performance (i.e. SML) considerably causes the investors in their decision. It is easy to find the limited impactful strength of interest rates in the EMEs although it is always considered as one of the most important policy tools utilised by most of the major Central Banks in controlling SML. *Monetary aggregates* have three positive unidirectional causal relationships flowing from Monetary aggregates to SML (i.e. Market resiliency, Market depth and Market immediacy) and two positive reverse

causalities with SML (i.e. Market tightness and Market diversity). These causalities imply that excessive monetary aggregates in an economy also increase the economy's overall liquidity position; hence, the investors' spending on securities leads to higher demand and an increase in stock prices. Similarly, the reverse situation makes stock prices decrease. Interestingly, the *Exchange rate* has a positive reverse causality moving from SML (i.e. Market tightness and Market diversity) to the Exchange rate. In other words, a stock-prices–lead-exchange-rates relation for only the cases when the currency follows a trend of appreciation or when the currency movement is stable. This result may reveal that capital inflows induced by foreign investments in the stock markets in the EMEs lead to an appreciation in the currency. The *Economic growth rate* has two positive bilateral causalities with SML (i.e. Market tightness and Market diversity). It recognises not only the significant importance of economic growth as a promotion of the stock market performance (i.e. SML) in the EMEs, but also the supportive importance of the stock market (i.e. SML) as a component of the financial system in the process of economic growth. The *Inflation rate* has two positive unilateral directional causalities running from the Inflation rate to SML (i.e. Market depth and Market tightness) and two positive reverse causalities with SML (i.e. Market resiliency and Market immediacy). The results reveal that the Inflation rate significantly determines SML in the EMEs; with an increase in inflation, every sector of the economy is influenced, and liquidity increases, while SML only has a slight role in determining the strategies of MOP of the EMEs affecting inflation. The *Treasury bill rate* has a positive unidirectional causality flowing from SML (i.e. Market resiliency) to The Treasury bill rate and two positive bi-directional causalities with SML (i.e., Market tightness and Market diversity). These

causal correlations reflect an essential implication that not only the interest rate policy (i.e. Treasury bill rate) of Central Banks of the EMEs considerably affects SML to create stable conditions for economic growth and sustainable development but also SML causes the investors in their decision to choose between the stock market and bank deposits.

The CS-ECM was used to reveal the short-run relationship between MOP and SML variables in EMEs and verify their long-run relationship in the presence of cross-sectional dependence with two lags of the cross-sectional averages added. In other words, the CS-ECM estimations gave more efficient results to confirm the presence of cointegration and to clarify the Granger causality under specific circumstances. The CS-ECM results showed that MOP also has short- and long-run effects on SML in EMEs. Although some differences in causality direction and sign appeared in the short- and long-term impacts, the CS-ECM results seemed acceptable due to the consideration of different lags added. These results provided evidence of the MOP-SML nexus in EMEs with fewer lags. More precisely, *Interest rate* slightly negatively influences SML (i.e. Market tightness) in the short period, which confirms a unidirectional causality running from Interest rate to Market tightness but has a change in its sign. It means that instead of being an adequate response, the Interest rate policy is considered as an emergency response for the lack of SML in the EMEs even though it is one of the most critical policy tools utilised by major Central Banks around the world in controlling SML. *Monetary aggregates* are significant and negative to SML (i.e. Market depth) in the short run. However, they become less significant and positive in the long run, which approves a positive unidirectional causality from Monetary aggregates to Market depth. Interestingly, Monetary aggregates negatively affect SML (i.e. Market tightness and

Market diversity) in the long period that conflicts with a positive reverse causality moving from SML to Monetary aggregates. It seems Central Banks tend to use Monetary aggregates to stabilise prices instead of Interest rates in the EMEs in the short and long periods. The *Economic growth rate* has a slightly negative influence on SML (i.e. Market resiliency) in the short term, which is not in line with two positive bilateral causalities flowing from Economic growth rate to Market tightness and Market diversity. It does not assert the important role of economic growth as a promotion of SML in the EMEs in the long term and even in the short term. The *Inflation rate* has a slightly negative effect on SML (i.e. Market tightness) in the long period that approves a unilateral directional causality moving from Inflation rate to Market tightness but has a different sign. Nevertheless, the Inflation rate slightly negatively impacts SML (i.e. Market immediacy) in the long period, not supporting a positive reverse causality moving from Market immediacy to Inflation rate. This contends that the Inflation rate does not considerably determine SML in the EMEs, and inflation targeting is still pursued in the MOP implementation of the EMEs in the long period. Intuitively, it also reveals that stock market investments can not actually provide a good hedge against inflation in the EMEs in the long period. However, the stock market performances (i.e. SML) benefited from the changes in the inflation rate, especially the decrease in the inflation rate. The decrease in the inflation rate may give a good sign to investors to invest in the stock market, as it means that there will be an expansion in the business sector; in turn, the returns of companies will increase. In the meantime, with a decrease in the inflation rate, it is expected that interest rates will decrease as well, and this will encourage investors to establish new firms and to find the required finance with less cost and so on. *The Treasury bill rate*

has a significant positive impact on SML (i.e. Market tightness and Market diversity) in the short and long run, which supports two positive bi-directional causalities flowing from the Treasury bill rate to Market tightness and Market diversity. It indicates that the interest rate policy (i.e. Treasury bill rate) of Central Banks of the EMEs considerably affects SML to create stable conditions for economic growth and sustainable development. It also concurs that the Treasury bill rate has a strong ability to adjust the short-term funds of the emerging stock markets, suggesting “a powerful effect” of the T-bills on SML even in the long run. Surprisingly, *the Exchange rate* does not show its impacts on SML characteristics in EMEs as its essential role in many macroeconomic fundamentals and investment decisions documented in the empirical literature.

All in all, the research results obtained by the cointegration tests, Granger causality tests and CS-ECM estimations confirmed hypotheses from H1 to H7 except for H4. However, the significance levels, directions and signs differed in each SML characteristic. In other words, *the causal link exists between MOP and SML in EMEs in the short and long term, except for the aspect of MOP, namely the Exchange rate*. Noticeably, the causality between MOP and SML asserts that MOP and SML are matters in which MOP is considered an essential determinant of SML, and SML plays a supportive role for MOP.

The findings of this study might have some necessary implications, especially for EMEs. Generally, Central Banks and investors should analyse variations in the sign and direction of the MOP-SML relationship in the short and long run before implementing any MOP or investment strategy.

Moreover, Central Banks and investors should also take into account that the correlation between the MOP and SML variables is different, with different SML characteristics, different features of monetary variables and different MOP goals and strategies. It must keep its eye on the ball and not lose sight of its core mandate. For instance, investors should consider that their investment strategies will depend on their investment horizons and the volatility of SML characteristics, while Central Banks should contemplate that monetary policies could have various positive and negative effects in the short and long term due to living under many guises.

Most selected MOP variables (except the Exchange rate) were identified as having an essential role in the financial market stability in general and SML in specific. In other words, SML could be highly boosted by managing some significant MOP variables in the short term (such as the Treasury bill rate, Monetary aggregates, Economic growth rate and Interest rate) and in the long term (such as the Treasury bill rate, Monetary aggregates and Inflation rate). Specifically, Central Banks should be advised to adopt an expansionary MOP focusing on “a specific goal set” which attracts new and potential investors to the stock markets. Central Banks could increase the money supply by purchasing Treasury securities (also known as Open Market Operations) in the short and long periods. That means the Treasury rates also would decrease in short and long periods. Simultaneously, Central Banks could decrease interest rates in the short run. High-interest rates harm higher economic growth, while low-interest rates would enhance stock market performance. It also would deliver an “inflation surprise” to the economy in the long run. However, that surprise could be a boost in driving economic growth in the short run. In this context, the depreciation in the exchange rate would happen, but it could be under control if Central Banks can maintain the “healthy exchange rate”. If the

financial market (especially the stock market) becomes well-developed and efficient, it would enhance domestic capital and attract foreign capital flows. Last but not least, in the context of the EMEs, which are countries with the less well-developed financial system, Central Banks should shape Monetary aggregates (i.e. Money supply) as an intermediate target in order to control the inflation rate based on the quantity theory of money, even though the efficiency of money supply stimulus may differ among the institutional environment. The Central Banks must have an intermediate target, the development of which guarantees an impact on the degree of the final target achievement. Together with the inflation targeting framework, the main target of MOP determined may be realised through different strategies in each EME.

5.6. LIMITATIONS AND FUTURE RESEARCH

Although this study has contributed to the overall insight causal association between MOP and SML in EMEs in the empirical literature with a dynamic panel model approach, some limitations are identified to address.

Firstly, the study considered BIC as a preferred criterion employed to determine a lag length in a regression framework throughout the dynamic causal linkage between MOP and SML due to its “best outperformed and most common” measure of the goodness of fit of a statistical model. “An appropriate technique” to find the correct lag order supporting the best fitting model selection for the dynamic causality and ensuring satisfy cointegration restrictions should be considered in this research circumstance.

Secondly, the study only assessed the short- and long-run causality in the entire emerging market area from 2000 to 2018. The answers to how short- and long-term causal correlations between MOP and SML are in

each selected emerging country in Crisis and Non-crisis periods are still “unfilled gaps” in this study.

Thirdly, the study revealed the dynamic relationship between MOP and SML in EMEs with causality from 2000 to 2018. However, the effect of MOP on SML relating to the location with a spatial approach was not clarified. It becomes necessary to investigate this issue as the findings noticeably evidence of the impact of financial globalisation on SML and MOP.

Future research can address these issues. Primarily, it can indicate how spillover effects of MOP on SML are in EMEs by applying a spatial approach.

CHAPTER 6



DISCUSSIONS AND CONCLUSIONS

6.1. OVERALL DISCUSSION AND CONCLUSIONS

The dissertation provides comprehensive insight into the overall impact of MOP on SML in EMEs by making a systematic theoretical and presenting empirical summary with static and dynamic approaches. The dissertation discloses significant empirical findings that considerably contribute to addressing the research questions and hypotheses. This dissertation implements one review study and two empirical studies to do so.

The first study is presented in Chapter 3, summarising theoretical and empirical literature on liquidity in stock markets of EMEs, the macroeconomic management of MOP and their relationship using a systematic literature review methodology.

This study compiles some central reviews and discussions about the association between MOP and SML in the extensive literature. Like related studies in developed and developing countries, mixed evidence of the impact of MOP on liquidity has been gathered in EMEs from the theoretical and empirical literature. Many studies of the MOP-SML nexus tend to focus on a specific single market of EMEs or areas or groups of some correlated economies, but a majority of studies have focused on advanced economies. Most of the research has no significant timeline separation for crisis periods. Numerous authors have studied the linkage between MOP and SML via different econometric models, focusing entirely on time-series analysis (e.g. VAR or OLS, or VECM). To sum up, the study gives a deeper understanding of liquidity and MOP by

reviewing the existing theoretical and empirical research on the topic. It reveals that different MOP implementations affect the stock market in general and SML in specific, and the effects of MOP tend to be asymmetric. It also presents evidence of a need for more timeline separation between the Crisis period and the Non-crisis period in an attempt to evaluate the relationship between MOP and SML.

The second study is presented in Chapter 4, *investigating the impact of MOP on SML in EMEs during Crisis and Non-crisis times with a static model approach. The results support that MOP affects SML in EMEs during Crisis and Non-crisis periods, and thus all the hypotheses from H1 to H7 are confirmed. The findings of this second study are in line with the suggestions of previous theoretical and empirical literature summarised systematically in Section 4.2 of Chapter 4. This second study concludes that MOP aspects impact SML in EMEs during Crisis and Non-crisis times, although the impact levels and signs are different in each SML characteristic.*

More specifically, Interest rate and Inflation rate are considered essential MOP aspects to SML in Crisis and Non-crisis times. Along with the Interest rate, the Treasury bill rate often tends to noticeably affect SML in both Crisis and Non-crisis periods due to the “risk-free” characteristic of the Treasury bill, particularly in the financial markets of the EMEs. Because of financial globalisation, the Exchange rate also influences SML during Crisis and Non-crisis times; especially, it becomes more significant to most SML characteristics in Non-crisis times. Based on the “inflation targeting” framework in the EMEs, which is focused primarily on achieving low and stable inflation, supportive of the economy’s growth objective, Economic growth is crucial to SML in the Crisis, while

Monetary aggregates are of great concern to enhance SML in the Non-crisis times.

During the GFC of 2007-2009, most EMEs loosened MOP considerably to cushion against the global financial shock and to boost economic recovery, and the seven selected EMEs were no exception. It is a remarkable departure from previous crisis episodes during which EMEs ordinarily had to increase interest rates to strengthen the credibility of MOP, preserve the value of their currencies, and hold the capital flight. More importantly, Central Banks, supporting the inflation targeting framework, still had to curb inflation expectations with flexible exchange rates. Noticeably, unconventional monetary and fiscal measures were also resorted to supporting as the primary means of stabilisation in each emerging country throughout the Crisis. By applying the static model approach of the FEM and the support of the FGLS estimation correcting the presence of heteroskedasticity, serial, and cross-sectional correlations, strategy similarities in the implementation of the easing MOP are confirmed in the selected EMEs during the Crisis period. Nevertheless, several opposite changes in the signs of MOP variables, including Interest rate, Money base, Economic growth rate and Exchange rate, appear during this Crisis when these EMEs adopted different MOP strategies at different times.

Unlike the policy strategies of the easing MOP conducted in the Crisis time, Central Banks of EMEs generally tend to adopt the tightening MOP in Non-crisis times. In other words, these Central Banks pursuing the MOP of “Leaning against the wind” involve a higher policy interest rate during these periods. Some changes in the signs of MOP variables affecting SML characteristics such as Money base, Interest rate and

Exchange rate appear in the Non-crisis periods due to different points for applying the contractionary MOP in each selected emerging country.

Market capitalisation and Financial globalisation affecting SML characteristics (except for Market resiliency) are clarified through the special features of correcting the error structure “HPAC” of the FGLS estimator, even though their signs are different. Interestingly, Financial globalisation strongly affects each SML characteristic, and it seems to be a reasonable explanation for a robust significant impact of the Exchange rate on each SML characteristic in Non-crisis times, except for Market resiliency. Besides, Market capitalisation is considered one of the aspects of stock market development, which provides an essential source of investment capital at relatively low costs. Financial globalisation has opened international capital markets to investors and companies and increased the financial sector’s growth. It reflects that Market capitalisation and Financial globalisation have necessitated a widening of the mandate of Central Banks with how they conduct MOP, especially in the phenomenon of Financial globalisation.

The third study is presented in Chapter 5, *shedding light on how MOP impacted SML in EMEs from 2000 to 2018 with a dynamic model approach. This third study obtains several significant findings conceding all hypotheses from H1 to H7, but H4 is an exception. The findings of this third study are consistent with the statements of previous theoretical and empirical literature summarised systematically in Section 5.2 of Chapter 5. This third study presents evidence that the causal relationship between MOP and SML in EMEs exists in the short and long run (except for the MOP aspect named Exchange rate), even though the significance levels, directions and signs differ in each SML characteristic.*

More specifically, *firstly*, the relationship between MOP and SML exists in the long run. *Secondly*, there are positive unidirectional and bi-directional causalities between MOP and SML characteristics, even though their significance levels are different. The Granger causality results generally imply that the interacted relationships between MOP and SML exist and are positively interdependent. This would mean that not only does MOP promote stock market performance (i.e. SML) as a determinant, but also SML assists MOP responses as a supporter with the function of the national economy “barometer”. Most of these causalities are in line with the suggestions obtained by previous studies regarding the association between MOP and SML. It can be listed as follows: the opposite theory of the classical theory “negative sign” of interest rate and the reverse causality; the “real activity” theory, the “wealth effect” (Friedman, 1988); the stock-oriented model (Frankel, 1983; Branson & Henderson, 1985); the “feedback” hypothesis; the “Fisher effect” hypothesis (Fisher, 1930) and the reverse causality. Precisely, the *Interest rate* has a positive one-way causality from Interest rate to SML and two positive reverse causalities. It is easy to find the limited impactful strength of interest rates in the EMEs even though it is always considered as one of the most important policy tools utilised by most major Central Banks in controlling SML. *Monetary aggregates* have three positive unidirectional causal relationships flowing from Monetary aggregates to SML and two positive reverse causalities. Excessive monetary aggregates in an economy also increase the economy’s overall liquidity position; hence the investors’ spending on securities leads to higher demand and an increase in stock prices. Similarly, the reverse situation makes stock prices decrease. Positive monetary aggregates (money supply shock) will lead people to anticipate tightening MOP in the future. The *Exchange rate*

merely has a positive reverse causality moving from SML to the Exchange rate. Capital inflows induced by foreign investments in the stock markets in the EMEs lead to an appreciation in the currency. The Economic growth rate has two positive bilateral causalities with SML. It recognises not only the significant importance of economic growth as a promotion of the stock market performance (i.e. SML) in the EMEs but also the supportive importance of the stock market (i.e. SML) as a component of the financial system in the process of economic growth. The *Inflation rate* has two positive unilateral directional causalities running from the Inflation rate to SML and two positive reverse causalities. The Inflation rate significantly determines SML in the EMEs with an increase in inflation, every sector of the economy is influenced, and liquidity increases, while SML only has a slight role in determining the strategies of MOP of the EMEs affecting inflation. The *Treasury bill rate* has a positive unidirectional causality flowing from SML to the Treasury bill rate and two positive bi-directional causalities with SML. Not only does the interest rate policy (i.e. Treasury bill rate) of Central Banks of the EMEs considerably affect SML to create stable conditions for economic growth and sustainable development. SML also causes investors to choose between the stock market and bank deposits. Knowing the direction of causality between MOP and SML is crucial because it has different implications for policy development (Central Banks and policymakers) and investment strategies (investors) both in the long run and short run. **Thirdly**, MOP has short- and long-run effects on SML. Interest rate and Economic growth rate tend to influence SML in the short run, whereas the Inflation rate affects SML in the long run. Both Monetary aggregates and the Treasury bill rate have short- and long-run impacts on SML. Precisely, *Interest rate* merely has a slight negative influence on

SML (i.e. Market tightness) in the short time of two years, suggesting a limited influence of the interest rate policy on SML in the long term. This result implies that the interest rate policy is an emergency response rather than an effective response to mounting concerns about the lack of SML. *Monetary aggregates* have mixed impacts on SML in the short and long run, but its effects tend to appear in the long run. They significantly influence SML (i.e. Market depth) with a negative sign in the short run, whereas this relationship becomes positive and less significant in the long run. They also negatively affect SML (i.e. Market tightness and Market diversity) in the long run. Together with the inflation targeting framework, despite the dominating role of Interest rates on the major Central Banks over the world, the outcomes from this study emphasise the role of Monetary aggregates as an intermediate target to control the inflation rate and to direct economic growth in the short and long run. The *Economic growth rate* only has a slight negative impact on SML (i.e. Market resiliency) in the short term. The effect of the Economic growth rate on SML is relatively limited in the short term, and it tends not to be found in the long term. It does not assert the significant importance of economic growth as a promotion of SML in the EMEs in the long term and even in the short term. The *Inflation rate* only has a slightly negative effect on SML (i.e. Market tightness and Market immediacy) in the long term. Intuitively, this result reflects that stock market investments can not actually provide a good hedge against inflation in the EMEs in the long term. However, it asserts that inflation targeting is still pursued in the MOP implementation of the EMEs in the long term, even though the inflation's impact is weak. The stock market performances (i.e. SML) benefited from the changes in the inflation rate, especially the decrease in the inflation rate. Besides, it must be addressed because inflation is a long-

term monetary phenomenon, and it has begun to play its role in affecting stock market performance (i.e. SML) everywhere, and the effects must be considered. *The Treasury bill rate* has a significant positive impact on SML (i.e. Market tightness and Market diversity) in the short and long run. This result implies that the money market rate (i.e. Treasury bill rate) has a strong ability to adjust the short-term funds of the stock markets of the EMEs, suggesting “a powerful effect” of the T-bills on SML even in the long run. It further confirms that the T-bills are typically regarded as a safe and conservative investment in the world in general and in the EMEs in particular, which most investors tend to choose to get a zero risk or to reduce a loss, especially safety-seeking investors.

6.2. THEORETICAL IMPLICATIONS

Regarding the theoretical contribution, the dissertation addresses the gap and under-explored issues in the literature in several ways.

First, this dissertation gives a deeper understanding of SML, MOP and their relationship in EMEs by systematically summarising the existing theoretical and empirical literature.

Second, this dissertation contributes to the emerging knowledge on the linkage between MOP and SML by providing an empirical model that better captures the overall impact of MOP on SML.

Third, this dissertation empirically provides a static picture of the relationship between MOP and SML in EMEs from normal (Non-crisis) to turbulent (Crisis) periods by applying the FEM approach.

Fourth, this dissertation seeks to understand the insight and empirically create a dynamic panorama of the association between MOP and SML in EMEs by employing the CS-ECM approach.

6.3. PRACTICAL IMPLICATIONS

Besides the theoretical implications, the author's work provides vital practical implications in the financial markets of EMEs (especially the stock markets) relating to the macroeconomic management of MOP of Central Banks and the investment strategy of investors.

Firstly, the author complements small literature linking MOP and SML. Indeed, the relationship between MOP and SML has been documented in empirical studies. However, academic research is still being determined concerning an overall linkage between them in EMEs, especially during Crisis and Non-crisis times. The author contributes to the MOP-SML literature by exploring their comprehensive relationship based on capturing overall MOP aspects and major SML characteristics.

Secondly, from a static perspective, the author concurred on the significance of MOP in the financial system in general and in the stock market in specific and how its responses affect the characteristics of SML in EMEs. The findings can help Central Banks identify clear MOP aspects that ensure the pursuit of their primary goals and enhance SML in both normal and turbulent periods, making it more attractive for capital investment. Accordingly, it supports investors in outlining and designing a strategy for their investment and makes final investment decisions easier.

Thirdly, from a dynamic perspective, the author provides significant insight and demonstrates a good understanding of the relationship between MOP and SML in EMEs. Accordingly, the causality between them indicates that MOP and SML are both matters in which MOP is considered an essential determinant of SML, and SML plays a supportive role for MOP. Indeed, MOP and SML are interdependent and mainly have positive bi-directional causality even though the causal effects from MOP to SML and the reverse effects do not fully appear in all SML

characteristics and in the same SML characteristics. Besides, the short- and long-run effects of MOP on SML are discovered in EMEs. The findings help Central Banks draw an insightful panorama of their correlations and develop appropriate strategies for capital flows' attraction and financial stability through a stock market channel.

In conclusion, from three studies, it can be observed that there exist significant interactions between macroeconomic variables of MOP and characteristics of SML in the EMEs in the normal time and turbulent times, in the short and long time. Accordingly, MOP affects SML as a macroeconomic determinant, and in turn, SML enhances MOP responses and its credibility as a microeconomic supporter. These relationships can be positive or negative depending on the variable being considered. In other words, it is necessary to incorporate a MOP environment for predicting SML. The author's work corroborates the fact that the macroeconomic environment (i.e. MOP) is crucial and should be closely monitored to ensure stability. Regions with stable macroeconomic environments enjoy increased activity at the stock market and thus an increased performance (i.e. SML). Regulators and policymakers may regard the relationship between MOP and SML as an essential source of information for policy formulation and implementation. Nevertheless, the macroeconomic management for promoting SML should consider the features of the critical MOP indicators to apply in normal and turbulent times, in the short and long run, and the causal relationship between MOP and SML. Attaching financial channels like SML (e.g. Chordia et al., 2000; Næs et al., 2011; Apergis et al., 2015) to macroeconomic modelling may be helpful for policymakers since liquidity encompasses vital information about the economy's condition. In parallel, investors may consider the correlation between MOP and SML as a reliable source for

business advice and investment because an appropriate MOP creates a safer investment environment (Hajilee & Niroomand, 2018). As such, investors may build their investment models in the financial markets with the support of well-known financial models and improve their investment decisions. In contrast, it can not be ignored that the function of financial markets (i.e. SML) is generally known as the “barometer” of the national economy and react to MOP first before economic activities, which relates to setting up MOP strategies and directing MOP responses.

6.4. LIMITATIONS AND FUTURE RESEARCH

Like other studies, despite the theoretical and practical contributions, the author’s work imposes some limitations that can provide future research opportunities.

First, the data sample size is relatively small for some reasons. The author used the yearly data for research because of the characteristic of MOP data. The findings will be more reliable if the sample size is big enough. The monthly or quarterly data can increase the sample size in future research. In addition, the number of countries studied still needs to be bigger to represent the area of EMEs even though they are opted with some criteria. The country selection can conduct for all continents, for instance, at least two countries in each continent. This selection will help address the linkage between MOP and SML and assess characteristics for each continent and the area of EMEs. It could be interesting to make similar studies using an alternative extended sample to ensure that the conclusions reached do not lead to different outcomes (Oskooe, 2010).

Second, the relationship between MOP and SML is addressed, focusing on the whole group of selected EMEs. The answers to how MOP influences SML in each selected country of EMEs still need to be solved.

Third, the relationship between MOP and SML is not consistently examined for both Crisis and Non-crisis periods in the entire research.

Fourth, the effect of MOP on SML relating to the location with a spatial approach needs to be clarified, although financial globalisation has a noticeable impact on their relationship. How spillover effects of MOP on SML are in EMEs by applying a spatial model approach should be clarified.

Fifth, all studies of the author's work only focus on how MOP affects SML in the EMEs in Crisis and Non-crisis times and their causal relationship in the short and long term. Despite the importance of knowledge on channels of MOP transmission, identifying the channels of the monetary transmission mechanism which are effective and providing some general inferences concerning which channels of MOP are working are not investigated and should be answered in future research.

Sixth, the impact of MOP on SML in the EMEs should be clearly investigated in the conventional and unconventional regimes of MOP. Understanding the different effects of conventional and unconventional policies on SML in the EMEs in normal and abnormal times is necessary.

Seventh, the author acknowledges the significance of considering goodness-of-fit measures for the parametric ranking model and model selection criteria. It should be appropriately conducted to boost the research reliability.

THE NEW SCIENTIFIC RESULTS

In general, several new scientific findings on the comprehensive relationship between MOP and SML literature in EMEs from 2000 to 2018 have been obtained (chiefly the impact of MOP on SML), which could be taken into consideration by researchers, regulators, policymakers and investors as follows:

1. The relationship between MOP and SML is appropriately clarified based on capturing overall aspects of MOP and major characteristics of SML, especially with a timeline separation between the Crisis and Non-crisis periods.

Accordingly, from theory to practice, the dissertation provides “a small complement” for the research model relating to the relationship between MOP and SML in EMEs in the existing empirical literature. This complement is proven to capture all MOP aspects and major SML characteristics through one theoretical study (in Chapter 3) and two practical studies (in Chapter 4 and 5) conducted by the author.

2. The linkage between MOP and SML is mixed and asymmetric (particularly the effect of MOP on SML), varying in different periods from normal to turbulent times, from short run to long run, in different SML characteristics, in different approaches and analysis methods.

More precisely, starting with the first study of the dissertation (in Chapter 3), the study compiles some central reviews and discussions about the linkage between MOP and SML in the extensive theoretical and empirical literature. Based on the literature review and drawbacks revealed in this first study, through two subsequent studies, the theoretical research model is proposed and investigated to evaluate their overall relationship in EMEs

with static and dynamic approaches as well as the consideration of timeline separation between the Crisis and the Non-crisis periods.

From a static perspective, the second study (in Chapter 4) indicates that MOP affects SML in EMEs during Crisis and Non-crisis times with various significance levels and signs in each SML characteristic, which means “different MOP implementations in different periods, then different SML states”. In other words, this second study validated all hypotheses proposed from H1 to H7 in the static model approach, conducted through the Fixed-Effects Model and Feasible Generalized Least Squares. Accordingly, there is a significant effect of MOP on SML in EMEs during Crisis and Non-crisis periods (H1 accepted). Specifically, Interest rate, Monetary aggregates, the Exchange rate, Economic growth rate, Inflation rate and Treasury bill rate have a negative or a positive impact on SML with different significance levels, respectively (H2, H3, H4, H5, H6 and H7 accepted).

From a dynamic perspective, the third study (in Chapter 5) reveals the interactive roles of MOP and SML in EMEs in light of the country’s economy in general and the national financial system in particular via their unidirectional and bi-directional causalities in EMEs. Moreover, the importance of MOP implementation for enhancing SML (even being able to forecast the volatility of SML) to achieve a stable and efficient financial system in EMEs in the short and long run is statistically asserted through short- and long-run effects of MOP on SML in this third study. By way of explanation, the third study asserted most hypotheses proposed from H1 to H7 (except H4) in the dynamic model approach, carried out via the Granger causality and Cross-Sectionally augmented Error Correction Model. Accordingly, a significant causal relationship exists between MOP and SML in emerging economies in the short and long

term (H1 accepted). Precisely, Interest rate and Economic growth rate have a negative causal influence on SML in EMEs in the short run (H2 and H5 accepted). In contrast, the Inflation rate has a negative causal one in the long run (H6 accepted). There is a positive causal effect of Monetary aggregates on SML in EMEs in the short and long time (H3 accepted). Treasury bill rates have mixed causal impacts (i. e. negative and positive impacts) on SML in EMEs in the short and long run (H7 accepted). Only the Exchange rate exists a reverse relationship from SML to Exchange rate and no effects on SML in EMEs in both the short and long term (H4 rejected).

3. The causal correlations between MOP and SML in EMEs mostly concur that MOP and SML are both matters in which MOP is considered an essential determinant of SML, and SML plays a supportive role for MOP.

More specifically, the primary reviews of the association between MOP and SML are summarised and detected in the first study (in Chapter 3), as well as the various impacts of MOP on SML in EMEs during Crisis and Non-crisis times conceded in the second study (in Chapter 4). In line with the findings of both studies, their causalities are precisely disclosed in the third study (in Chapter 5). Accordingly, it reflects that not only does MOP promote SML as a determinant, but SML also assists MOP responses as a supporter with the function of the national economy “barometer”.

SUMMARY

The dissertation aims to comprehensively evaluate and determine the impact of MOP on SML in EMEs at the country level. It regards how the impact of MOP on SML is concluded in the theoretical and empirical literature, how MOP empirically affects SML during the Crisis and Non-crisis periods, which direction the correlation between MOP and SML empirically runs, how MOP responses to SML are empirically in the short and long run. Using secondary panel data with the selected criteria from seven countries in EMEs over the period ranging from 2000 to 2018, the dissertation empirically assesses the overall impact of MOP on SML along with static and dynamic perspectives.

More specifically, the dissertation conducts one review study and two empirical studies to address the research objectives and empirically test the hypotheses.

In Chapter 3, the dissertation offers a summary of the theoretical and empirical literature on liquidity in stock markets of EMEs, the macroeconomic management of MOP, and their relationship is provided by adopting a systematic literature review methodology. The entire systematic literature deepens understanding of MOP, SML and their connection, indicates optimal MOP and SML measures for the research and helps expose unfilled research gaps.

In Chapter 4, the dissertation discovers the impact of MOP on SML in EMEs during Crisis and Non-crisis periods, although the impact levels and signs are different in each SML characteristic. From the static perspective, the static model approach is applied to assess how MOP responses to SML vary from normal to turbulent times, namely the FEM.

In Chapter 5, the dissertation discloses insight association between MOP and SML in EMEs throughout the research period from 2000 to 2018. The short- and long-run influences of MOP on SML are detected by utilising the dynamic model approach, namely the CS-ECM, although the significance levels, directions and signs were different in each SML characteristic considered. Moreover, the causal correlations are revealed, asserting that both MOP and SML matter to each other with their roles.

ACKNOWLEDGEMENT

It is my happiness and honour to express my deepest gratitude to the people who have been my supporters throughout this long PhD journey.

Firstly, having the opportunity to study at this prestigious university and pursue my PhD programme would not have been possible without the scholarship provider's generous support from the Stipendium Hungaricum. Simultaneously, the Vietnam International Education Development (VIED) opened the first door getting a chance for the scholarship. Furthermore, without the Hungarian University of Agriculture and Life Sciences (especially MATE Kaposvár Campus), it would be impossible for me to have a chance for good educational background. Additionally, the acceptance and time support for my PhD programme from the Board of Directors, the Human Resources Department, the Deans' Committee and colleagues of the Faculty of Finance - Banking, and other university colleagues at the University of Finance - Marketing in Vietnam mean a lot.

I also would like to say a special thank you to the dissertation committee members and opponents, who have given me a chance to present my PhD research work in the pre-defence and final defence, who have made fair dissertation comments as meaningful advice to help me have better work and sincere compliments to bring more motivation.

Words cannot express my gratitude to respectful professors in Hungary: my supervisor - Dr. TIBOR TATAY - who has supported me with my papers and dissertation; Prof. Dr. SÁNDOR KERÉKES, Prof. Dr. Imre Fertő, Prof. Dr. Gergely Tóth, Prof. Dr. Zoltán Gál, Dr. habil. Szilárd Berke, Dr. György Kövér, Dr. Bernadette Nagyházi and Prof. Dr. István Nagy - who have taught and provided me extensive professional and personal guidance at MATE Kaposvár Campus; Dr. Kinga Szabó, Mrs. Katalin Laczkó, Dr. Gyöngyi Bánkúti, and other staff members of the MATE Kaposvár Campus (especially Mr. László Hahn, Miss. Zsófia Móga, Ms. Bianka Gedóvári, Miss. Klaudia Polgár and some former staff

members) - who have always been willing to help me. Besides, I am grateful to respectful Dr. BUI HUU PHUOC (University of Finance - Marketing) has been a great and thoughtful mentor in my personal and professional life since my first working day at the university; Prof. Le Van Huy and Dr. Phan Hoang Long (University of Economics - The University of Danang) have tried to give me support and encouragement throughout my study. My sincere thanks go to Dr. PHAN HOANG LONG for giving valuable advice to improve this dissertation.

Old friends and students in Vietnam, together with new friends I met in Hungary, have made my life more beautiful and meaningful. I highly appreciate these friends who have walked alongside me and have given me insightful personal and professional support for the last five years: Mrs. Tran Lan Huong, Mr. Nguyen Truong Duy Phong, Mr. Le Van Tuan, Dr. Dinh Quang Cuong, Dr. Pham Minh Tuan, Dr. Pham Thuy Tu, Miss. Dao Thi Kim Phuong, Miss. Fatima Ezzahra Imouzaz, Mrs. Barbara Gorman, Dr. Александр Титов, especially Dr. TRAN THANH TAN, МЕс. NGUYEN MAU BA DANG, Miss. TRAN LE PHUONG LAN, Dr. ERJAN AKHMEDOV, Dr. MOHANAD ALI KAREEM, PhD candidate OLEKSANDR KODAK and MBA. HAPPI KUMAR.

However, I would be remiss not to mention the most crucial part of my life and motivation: My beloved family. My late grandmother MAI THI TUNG, my late father HOANG ANH LIEU, my mother TON NU KIM PHUONG, two of my younger sisters (HOANG TON THAO TIEN and HOANG TON THIEN MINH), my brother-in-law TRONG DUNG, my nephew PAUL and my niece SURI, and the special friend of my family Mr. LE XUAN GIANG - have continuously impacted and inspired me. Their belief in me has kept my spirits and motivation high.

In my final words, it can not be the work of one person, and definitely, it is a fruitful result of everyone who is beside me in the past, in the present and in the future.

HOÀNG TÔN THANH UYÊN
(Uyen Thanh HOANG TON)

REFERENCES

- Abdelbaki, H. H. (2013). Causality relationship between macroeconomic variables and stock market development: Evidence from Bahrain. *The International Journal of Business and Finance Research* ♦, 7(1), 69–84.
- Abdelmonem, L., & Mohamed, K. (2018). The impact of Treasury bill rate and interest rate on the stock market returns in Egypt. *International Journal of Development and Sustainability*, 7(2), 604–619.
- Abu @ Hussin, M., Mohd. Hussin, M., Muhammad, F., & Awang, S. (2012). Macroeconomic variables and Malaysian Islamic stock market: A time series analysis. *The Journal of Business Studies Quarterly (JBSQ)*, 3(4), 1–13.
- Adam, A. M., & Tweneboah, G. (2011). Macroeconomic factors and stock market movement: Evidence from Ghana. *SSRN Electronic Journal*. <https://doi.org/10.2139/ssrn.1289842>
- Addo, A., & Sunzuoye, F. (2013). The impact of Treasury Bill rate and interest rate on the stock market returns: Case of Ghana stock exchange. *European Journal of Business and Economics*, 8(2). <https://doi.org/10.12955/ejbe.v8i2.378>
- Adusei, M. (2014). The inflation-stock market returns nexus: Evidence from the Ghana stock exchange. *Journal of Economics and International Finance*, 6(2), 38–46. <https://doi.org/10.5897/jeif2013.0556>
- Ahmad, N. (2007). The relation between stock prices and money supply in Pakistan: An investigation. *Journal of Independent Studies and Research-Management, Social Sciences and Economics*, 5(2), 30–32. <https://doi.org/10.31384/jirmsse/2007.05.2.2>
- Ajayi, R. A., Friedman, J., & Mehdian, S. M. (1998). On the relationship between stock returns and exchange rates: Tests of Granger causality. *Global Finance Journal*, 9(2), 241–251. [https://doi.org/10.1016/s1044-0283\(98\)90006-0](https://doi.org/10.1016/s1044-0283(98)90006-0)
- Ajayi, R. A., & Mougoué, M. (1996). On the dynamic relation between stock prices and exchange rates. *Journal of Financial Research*,

19(2), 193–207. <https://doi.org/10.1111/j.1475-6803.1996.tb00593.x>

- Akel, V., Kandır, S. Y., & Yavuz, Ö. S. (2016). Dynamic relationship between stock prices and exchange rates in emerging markets: Evidence from fragile five economies. *International Business: Concepts, Methodologies, Tools, and Applications*, 2257–2273. <https://doi.org/10.4018/978-1-4666-9814-7.ch103>
- Al Rasasi, M. H., Alsabban, S. O., & Alarfaj, O. A. (2019). Does stock market performance affect economic growth? Empirical evidence from Saudi Arabia. *International Journal of Economics and Finance*, 11(9), 21. <https://doi.org/10.5539/ijef.v11n9p21>
- Alam, M. M., & Uddin, M. G. S. (2009). Relationship between interest rate and stock price: Empirical evidence from developed and developing countries. *International Journal of Business and Management*, 4(3). <https://doi.org/10.5539/ijbm.v4n3p43>
- Alatqi, S., & Fazel, S. (2008). Can money supply predict stock prices? *Journal for Economic Educators*, 8(2), 54–59. <https://161.45.205.92/index.php/jfee/article/view/1450>
- Alexakis, P., Apergis, N., & Xanthakis, E. (1996). Inflation volatility and stock prices: Evidence from ARCH effects. *International Advances in Economic Research*, 2(2), 101–111. <https://doi.org/10.1007/BF02295049>
- Ali, I., Rehman, K., Yilmaz, A. K., Aslam, M., & Hasan, A. (2010). Causal relationship between macroeconomic indicators and stock exchange prices in Pakistan. *African Journal of Business Management*, 4(3), 312–319.
- Amihud, Y., Mendelson, H., & Pedersen, L. H. (2005). Liquidity and asset prices. *Foundations and Trends in Finance*, 1(4), 269–364. <https://doi.org/10.1561/05000000003>
- Amin, S. I. M., & Janor, H. (2016). The Co-movement between exchange rates and stock prices in an emerging market. *Jurnal Pengurusan*, 48(1), 161–172. <https://doi.org/10.17576/pengurusan-2016-48-05>
- Anari, A., & Kolari, J. (2001). Stock prices and inflation. *Journal of Financial Research*, 24(4), 587–602. <https://doi.org/10.1111/j.1475-6803.2001.tb00832.x>
- Ando, A., & Modigliani, F. (1963). The “Life cycle” hypothesis of saving: Aggregate implications and tests. *The American Economic*

- Review*, 53(1), 55–84. <https://doi.org/10.1126/science.151.3712.867-a>
- Andreou, E., Matsi, M., & Savvides, A. (2013). Stock and foreign exchange market linkages in emerging economies. *Journal of International Financial Markets, Institutions and Money*, 27(1), 248–268. <https://doi.org/10.1016/j.intfin.2013.09.003>
- Ang, A., Piazzesi, M., & Wei, M. (2006). What does the yield curve tell us about GDP growth? *Journal of Econometrics*, 131(1–2), 359–403. <https://doi.org/10.1016/j.jeconom.2005.01.032>
- Antonakakis, N., Gupta, R., & Tiwari, A. K. (2017). Has the correlation of inflation and stock prices changed in the United States over the last two centuries? *Research in International Business and Finance*, 42, 1–8. <https://doi.org/10.1016/j.ribaf.2017.04.005>
- Apergis, N., Artikis, P. G., & Kyriazis, D. (2015). Does stock market liquidity explain real economic activity? New evidence from two large European stock markets. *Journal of International Financial Markets, Institutions and Money*, 38, 42–64. <https://doi.org/10.1016/j.intfin.2015.05.002>
- Apergis, N., Filippidis, I., & Economidou, C. (2007). Financial deepening and economic growth linkages: A panel data analysis. *Review of World Economics*, 143(1), 179–198. <https://doi.org/10.1007/s10290-007-0102-3>
- Archana, U. (2016). Causality relationship between interest rate and stock returns in India - An analytical study. *Apeejay-Journal of Management Sciences and Technology*, 4(1), 37–46.
- Arikunto, S. (2010). Research procedure a practical approach. *Jakarta: Rineka Cipta*, 152.
- Arjoon, R., Botes, M., Chesang, L. K., & Gupta, R. (2012). The long-run relationship between inflation and real stock prices: Empirical evidence from South Africa. *Journal of Business Economics and Management*, 13(4), 600–613. <https://doi.org/10.3846/16111699.2011.620162>
- Asai, M., & Shiba, T. (1995). The Japanese stock market and the macroeconomy: An empirical investigation. *Financial Engineering and the Japanese Markets*, 2(3), 259–267. <https://doi.org/10.1007/BF02425199>

- Attari, M. I. J., & Safdar, L. (2013). The relationship between macroeconomic volatility and the stock market volatility: Empirical evidence from Pakistan. *Pakistan Journal of Commerce and Social Sciences*, 7(2), 309–320.
- Aziza, F. O. F. (2012). The effects of monetary policy on stock market performance: A cross-country analysis. *SSRN Electronic Journal*. <https://doi.org/10.2139/ssrn.1743834>
- Babangida, J. S., & Khan, A.-U. I. (2021). Effect of monetary policy on the Nigerian stock market: A smooth transition autoregressive approach. *Central Bank of Nigeria Journal of Applied Statistics*, 12(No. 1), 1–21. <https://doi.org/10.33429/cjas.12121.1/6>
- Bahmani-Oskooee, M., & Sohrabian, A. (1992). Stock prices and the effective exchange rate of the dollar. *Applied Economics*, 24(4), 459–464. <https://doi.org/10.1080/00036849200000020>
- Baker, H. K. (1996). Trading location and liquidity: An analysis of U.S. dealer and agency markets for common stocks. *Financial Markets, Institutions and Instruments*, 5(5), 1–51.
- Baker, H. Kent, Singleton, J. C., & Veit, E. T. (2011). Survey research in corporate finance: Bridging the gap between theory and practice. In *Survey Research in Corporate Finance: Bridging the Gap between Theory and Practice*. <https://doi.org/10.1093/acprof:oso/9780195340372.001.0001>
- Baltagi, B. H. (2005). *Econometric analysis of panel data - Third edition*. In *John Wiley & Sons*, 2008.
- Banerjee, A., Marcellino, M., & Osbat, C. (2005). Testing for PPP: Should we use panel methods? *Empirical Economics*, 30(1), 77–91. <https://doi.org/10.1007/s00181-004-0222-8>
- Bech, M. L., Gambacorta, L., & Kharroubi, E. (2014). Monetary policy in a downturn: Are financial crises special? *International Finance*, 17(1), 99–119. <https://doi.org/10.1111/infi.12040>
- Benić, V., & Franić, I. (2008). Stock market liquidity: Comparative analysis of Croatian and regional markets. *Financial Theory and Practice*, 32(4), 477–498.
- Bernanke, B. S., & Gertler, M. (1999). Monetary policy and asset price volatility. *Federal Reserve Bank of Kansas City Economic Review*, 84, 17–51.

- Bernanke, B. S., & Kuttner, K. N. (2005). What explains the stock market's reaction to Federal reserve policy? *Journal of Finance*, 60(3), 1221–1257. <https://doi.org/10.1111/j.1540-6261.2005.00760.x>
- Bhattacharya, B., & Mukherjee, J. (2006). Indian stock price movements and the macroeconomic context - A time series analysis. *Journal of International Business and Economics*, 5(1), 167–181.
- Bhattarai, R. C., & Joshi, N. K. (2009). Dynamic relationship among the stock market and the macroeconomic factors: Evidence from Nepal. *South Asia Economic Journal*, 10(2), 451–469. <https://doi.org/10.1177/139156140901000208>
- Binswanger, M. (2000). Stock returns and real activity: Is there still a connection? *Applied Financial Economics*, 10(4), 379–387. <https://doi.org/10.1080/09603100050031507>
- Binswanger, M. (2004). Stock returns and real activity in the G-7 countries: Did the relationship change during the 1980s? *Quarterly Review of Economics and Finance*, 44(2), 237–252. <https://doi.org/10.1016/j.qref.2003.07.001>
- Bissoon, R., Seetanah, B., Bhattu-Babajee, R., Gopy-Ramdhaney, N., & Seetah, K. (2016). Monetary policy impact on stock return: Evidence from growing stock markets. *Theoretical Economics Letters*, 06(05), 1186–1195. <https://doi.org/10.4236/tel.2016.65112>
- Blanchard, O. (2013). Monetary policy will never be the same. *IMFdirect*. <http://blog-imfdirect.imf.org/2013/11/19/monetary-policy-will-never-be-the-same/>
- Blinder, A., Ehrmann, M., de Haan, J., & Jansen, D.-J. (2017). What will monetary policy look like after the crisis? *Research Bulletin*, 39.
- Borjigin, S., Yang, Y., Yang, X., & Sun, L. (2018). Econometric testing on linear and nonlinear dynamic relation between stock prices and macroeconomy in China. *Physica A: Statistical Mechanics and Its Applications*, 493, 107–115. <https://doi.org/10.1016/j.physa.2017.10.033>
- Branson, W. H., Halttunen, H., & Masson, P. (1977). Exchange rates in the short run: The dollar-denschemark rate. *European Economic Review*, 10(3), 303–324. [https://doi.org/10.1016/S0014-2921\(77\)80002-0](https://doi.org/10.1016/S0014-2921(77)80002-0)
- Branson, W. H., & Henderson, D. W. (1985). The specification and

- influence of asset markets. *Handbook of International Economics*, 2(C), 749–805. [https://doi.org/10.1016/S1573-4404\(85\)02006-8](https://doi.org/10.1016/S1573-4404(85)02006-8)
- Bredin, D., Hyde, S., Nitzsche, D., & Gerard, O. (2007). UK stock returns and the impact of domestic monetary policy shocks. *Journal of Business Finance & Accounting*, 34(5, July), 872–888. <https://doi.org/10.1111/j.1468-5957.2006.02001.x>
- Breitung, J. (2000). The local power of some unit root tests for panel data. In *Advances in Econometrics* (Vol. 15). [https://doi.org/10.1016/S0731-9053\(00\)15006-6](https://doi.org/10.1016/S0731-9053(00)15006-6)
- Breitung, J., & Pesaran, M. H. (2008). Unit roots and cointegration in panels. *Advanced Studies in Theoretical and Applied Econometrics*, 46, 279–322. https://doi.org/10.1007/978-3-540-75892-1_9
- Brennan, M. J., Chordia, T., Subrahmanyam, A., & Tong, Q. (2012). Sell-order liquidity and the cross-section of expected stock returns. *Journal of Financial Economics*, 105(3), 523–541. <https://doi.org/10.1016/j.jfineco.2012.04.006>
- Breusch, T., & Pagan, A. (1980). The Lagrange Multiplier test and its application to model specification in econometrics. *Review of Economic Studies*, 47(1), 239–253.
- Breusch, T. S., & Pagan, A. R. (1980). The Lagrange Multiplier test and its applications to model specification in econometrics. *The Review of Economic Studies*, 47(1), 239–253. <https://doi.org/10.2307/2297111>
- Brooks, C. (2014). Introductory Econometrics for Finance. In *Cambridge University Press, New York: Vol. 3rd ed.*
- Bulmash, S. B., & Trivoli, G. W. (1991). Time-lagged interactions between stocks prices and selected economic variables. *The Journal of Portfolio Management*, 17(4), 61–67. <https://doi.org/10.3905/jpm.1991.409351>
- Bulmer, M. G. (1979). Principles of statistics. In *Dover Publications, Inc., New York.*
- Busch, T., & Lehnert, T. (2014). The impact of policy responses on stock liquidity. *Applied Economics Letters*, 21(12), 842–845. <https://doi.org/10.1080/13504851.2014.892193>
- Büyüksalvarci, A., & AbdIoğlu, H. (2010). The causal relationship

- between stock prices and macroeconomic variables: A case study for Turkey. *International Journal of Economic Perspectives*, 4(4), 601–610.
- Cameron, C. A., & Trivedi, P. K. . (2009). *Microeconometrics using Stata*. *Stata Press*.
- Celebi, K., & Hönig, M. (2019). The impact of macroeconomic factors on the German stock market: Evidence for the crisis, pre-and post-crisis periods. *International Journal of Financial Studies*, 7(2). <https://doi.org/10.3390/ijfs7020018>
- Chai, D., Faff, R., & Gharghori, P. (2010). New evidence on the relation between stock liquidity and measures of trading activity. *International Review of Financial Analysis*, 19(3), 181–192. <https://doi.org/10.1016/j.irfa.2010.02.005>
- Chancharat, N., Intharak, K., Chancharat, S., & Chamnongnit, P. (2022). Stock market development and Economic growth in Thailand: An ARDL approach. *GMSARN International Journal*, 16(2), 174–181.
- Chen, N., Roll, R., & Ross, S. A. (1986). Economic forces and the stock market. *Journal of Business*, 59, 383–403.
- Cheung, D. W. . (1990). The causal relationship among stock prices, money supply and interest rates in Hong Kong under the linked exchange rate system. *Asia-Pacific Business: Proceedings, AIBSEAR Conference Hong Kong, June 26-28, 1990*, 383–388.
- Chinzara, Z. (2010). Macroeconomic uncertainty and emerging market stock market volatility: The case for South Africa. *Economic Research Southern Africa*, August.
- Chordia, T., Brennan, M., Estrella, A., Fleming, M., & Hughson, E. (2001). Common determinants of bond and stock market liquidity: The impact of financial crises, monetary policy, and mutual fund flows. *SSRN Electronic Journal*, 1–51.
- Chordia, T., Roll, R., & Subrahmanyam, A. (2000). Commonality in liquidity. *Journal of Financial Economics*, 56(1), 3–28. [https://doi.org/10.1016/S0304-405X\(99\)00057-4](https://doi.org/10.1016/S0304-405X(99)00057-4)
- Chordia, T., Sarkar, A., & Subrahmanyam, A. (2005). An empirical analysis of stock and bond market liquidity. *Review of Financial Studies*, 18(1), 85–129. <https://doi.org/10.1093/rfs/hhi010>

- Choudhry, T. (1996). Real stock prices and the long-run money demand function: Evidence from Canada and the USA. *Journal of International Money and Finance*, 15(1), 1–17. [https://doi.org/10.1016/0261-5606\(95\)00041-0](https://doi.org/10.1016/0261-5606(95)00041-0)
- Chowdhury, A., Uddin, M., & Anderson, K. (2018). Liquidity and macroeconomic management in emerging markets. *Emerging Markets Review*, 34, 1–24. <https://doi.org/10.1016/j.ememar.2017.10.001>
- Chu, X. (2015). Modelling impact of monetary policy on stock market liquidity: A dynamic copula approach. *Applied Economics Letters*, 22(10), 820–824. <https://doi.org/10.1080/13504851.2014.980566>
- Chudik, A., & Pesaran, M. H. (2015). Common correlated effects estimation of heterogeneous dynamic panel data models with weakly exogenous regressors. *Journal of Econometrics*, 188(2), 393–420.
- Ciccarelli, M., Maddaloni, A., & Peydró, J. L. (2013). Heterogeneous transmission mechanism: Monetary policy and financial fragility in the eurozone. *Economic Policy*, 28(75), 459–512. <https://doi.org/10.1111/1468-0327.12015>
- Cooper, D. R., & Schindler, P. S. (2011). Business research methods. In *11th Edition, McGraw-Hill, Boston*.
- Coulibaly, B. (2012). Monetary policy in emerging market economies: What lessons from the Global Financial Crisis? *SSRN Electronic Journal*. <https://doi.org/10.2139/ssrn.2026515>
- Darrat, A. F., & Dickens, R. N. (1999). On the interrelationship among real, monetary, and financial variables. *Applied Financial Economics*, 9, 289–293.
- Davis, J. H., Aliaga-Díaz, R., Cole, W., & Shanahan, J. (2010). Investing in emerging markets: Evaluating the allure of rapid economic growth. *Vanguard Research, April*, 1–12.
- Debata, B., Dash, S. R., & Mahakud, J. (2021). Monetary policy and liquidity: Does investor sentiment matter? *IIMB Management Review*, 33(3), 257–277. <https://doi.org/10.1016/j.iimb.2021.07.001>
- Debata, B., & Mahakud, J. (2018). Interdependence between monetary policy and stock liquidity: A Panel VAR approach. *Margin*, 12(4), 387–413. <https://doi.org/10.1177/0973801018786270>

- Demir, C. (2019). Macroeconomic determinants of stock market fluctuations: The case of BIST-100. *Economies*, 7(1), 1–14. <https://doi.org/10.3390/economies7010008>
- Dewasiri, N. J., & Weerakoon Banda, Y. K. (2016). Why do companies pay dividends?: A comment. *Corporate Ownership and Control*, 13(2CONT2), 443–453. <https://doi.org/10.22495/cocv13i2c2p5>
- Diamandis, P. F., & Drakos, A. A. (2011). Financial liberalization, exchange rates and stock prices: Exogenous shocks in four Latin America countries. *Journal of Policy Modeling*, 33(3), 381–394. <https://doi.org/10.1016/j.jpolmod.2010.11.004>
- Dimson, E., Marsh, P., & Staunton, M. (2002). Triumph of the optimists. In *Princeton University Press, Princeton, New Jersey*. <https://doi.org/10.1515/9781400829477>
- Ditzen, J. (2021). Estimating long-run effects and the exponent of cross-sectional dependence: An update to xtdcce2. *Stata Journal*, 21(3), 687–707. <https://doi.org/10.1177/1536867X211045560>
- Dornbusch, R., & Fischer, S. (1980). Exchange rates and the current account. *Am Econ Rev*, 70(5), 960–971.
- Driscoll, J. C., & Kraay, A. C. (1998). Consistent covariance matrix estimation with spatially dependent panel data. *Review of Economics and Statistics*, 80(4), 549–559. <https://doi.org/10.1162/003465398557825>
- Dumitrescu, E. I., & Hurlin, C. (2012). Testing for Granger non-causality in heterogeneous panels. *Economic Modelling*, 29(4), 1450–1460. <https://doi.org/10.1016/j.econmod.2012.02.014>
- Eberhardt, M., & Presbitero, A. F. (2015). Public debt and growth: Heterogeneity and non-linearity. *Journal of International Economics*, 97, 45–58.
- ECB. (2010). The ECB's Response to the Financial Crisis. *Monthly Bulletin-October*.
- Ekinci, C., Akyildirim, E., & Corbet, S. (2019). Analysing the dynamic influence of US macroeconomic news releases on Turkish stock markets. *Finance Research Letters*, 31, 155–164. <https://doi.org/10.1016/j.frl.2019.04.021>
- El-Wassal, K. A. (2005). Understanding the growth in emerging stock

- markets. *Journal of Emerging Market Finance*, 4(3), 227–261. <https://doi.org/10.1177/097265270500400302>
- El Abed, R. (2017). Exploring the nexus between stock prices and macroeconomic shocks: Panel VAR approach. *Economics Bulletin*, 37(3), 1–15.
- Ellington, M. (2018). Financial market illiquidity shocks and macroeconomic dynamics: Evidence from the UK. *Journal of Banking and Finance*, 89, 225–236. <https://doi.org/10.1016/j.jbankfin.2018.02.013>
- Elton, E. J., & Gruber, M. J. (1995). Modern portfolio theory and investment analysis. In (5th edition), *John Wiley & Sons, Inc., USA*.
- Estrella, A., & Mishkin, F. S. (1998). Predicting U.S. Recessions: Financial variables as leading indicators. *Review of Economics and Statistics*, 80(1), 45–56. <https://doi.org/10.1162/003465398557320>
- Fama, E. F. (1981). Stock returns, real activity, inflation, and money. *American Economic Review*, 71(4), 545–565.
- Federal Reserve Bank of San Francisco. (2005). *Annual report*. <https://www.frbsf.org/wp-content/uploads/2005annualreport.pdf>
- Feldstein, M. (1980). Inflation and the stock market. *American Economic Review*, 70, 839–847.
- Firth, M. (1979). The relationship between stock market returns and rates of inflation. *The Journal of Finance*, 34(3), 743–749. <https://doi.org/10.1111/j.1540-6261.1979.tb02139.x>
- Fisher, I. (1930). The theory of interest. *New York: Macmillan. Library of Economics and Liberty*.
- Frankel, J. (1983). Monetary and portfolio-balance models of exchange rate determination. In: *Bhandari J, Putnam B (Eds) Economic Interdependence and Flexible Exchange Rates. MIT Press, Cambridge, MA.*, 84–114.
- Friedman, M. (1977). Inflation and unemployment. *Journal of Political Economy*, 85(3), 451–472.
- Friedman, Milton. (1988). Money and the stock market. *Journal of Political Economy*, 96(2), 221–245. <https://doi.org/10.1086/261534>
- Fujimoto, A., & Watanabe, A. (2004). Macroeconomic sources of

- systematic liquidity. In *Working Paper* (Vol. 2004, Issue 780). <https://doi.org/10.2139/ssrn.598781>
- Garnia, E., Rizal, D., Tahmat, T., & Ayu Febianti Lebeharia, A. (2022). Impacts of macroeconomic factors on stock returns in the property sector. *KnE Social Sciences*, 59–68. <https://doi.org/10.18502/kss.v7i6.10609>
- Geske, R., & Roll, R. (1983). The fiscal and monetary linkage between stock returns and inflation. *The Journal of Finance*, 38(1), 1–33. <http://dx.doi.org/10.1111/j.1540-6261.1983.tb03623>.
- Goswami, G., & Jung, S.-C. (1997). *Stock market and economic forces: Evidence from Korea. October*.
- Goyenko, R. Y., Holden, C. W., & Trzcinka, C. A. (2009). Do liquidity measures measure liquidity? *Journal of Financial Economics*, 92(2), 153–181. <https://doi.org/10.1016/j.jfineco.2008.06.002>
- Goyenko, R. Y., & Ukhov, A. D. (2009). Stock and bond market liquidity: A long-run empirical analysis. *Journal of Financial and Quantitative Analysis*, 44(1), 189–212. <https://doi.org/10.1017/S0022109009090097>
- Graham, F. C. (1996). Inflation, real stock returns, and monetary policy. *Applied Financial Economics*, 6(1), 29–35. <https://doi.org/10.1080/096031096334448>
- Granger, C. W. J. (1969). Investigating causal relations by econometric models and cross-spectral methods. *Econometrica*, 37(3), 424–438. <https://doi.org/10.2307/1912791>
- Granger, Clive W.J., Huangb, B. N., & Yang, C. W. (2000). A bivariate causality between stock prices and exchange rates: Evidence from recent Asian flu. *Quarterly Review of Economics and Finance*, 40(3), 337–354. [https://doi.org/10.1016/s1062-9769\(00\)00042-9](https://doi.org/10.1016/s1062-9769(00)00042-9)
- Grbić, M. (2021). Stock market development and economic growth: The case of the Republic of Serbia. *Post-Communist Economies*, 33(4), 484–499. <https://doi.org/10.1080/14631377.2020.1745566>
- Greenwood, J., & Smith, B. D. (1997). Financial development and the development of financial markets. *Journal of Economic Dynamics and Control*, 21, 145–181.
- Gregoriou, A., Kontonikas, A., MacDonald, R., & Montagnoli, A. (2009).

- Monetary policy shocks and stock returns: Evidence from the British market. *Financial Markets and Portfolio Management (FMPM)*, 23, 401–410.
- Gujarati, D. N., Porter, D. C., & Gunasekar, S. (2012). Basic econometrics. In *McGraw Hill: Vol. 5th ed.*
- Gupta, R., & Inglesi-Lotz, R. (2012). Macro shocks and real us stock prices with special focus on the great recession. *Applied Econometrics and International Development*, 12(2), 123–136.
- Gurung, R. (2020). Relationship between Treasury bill rate and NEPSE index in Nepal. *Pravaha*, 25(1), 159–166. <https://doi.org/10.3126/pravaha.v25i1.31951>
- Gust, C., & López-Salido, D. (2014). Monetary policy and the cyclicity of risk. *Journal of Monetary Economics*, 62(1), 59–75. <https://doi.org/10.1016/j.jmoneco.2013.11.008>
- Gwynne, R. N., Klak, T., & Shaw, D. J. B. (2003). *Alternative capitalisms: Geographies of emerging regions.*
- Hadri, K. (2000). Testing for stationarity in heterogeneous panel data. *The Econometrics Journal*, 3(2), 148–161. <https://doi.org/10.1111/1368-423x.00043>
- Hajilee, M., & Niroomand, F. (2018). The impact of interest rate volatility on financial market inclusion: Evidence from emerging markets. *Journal of Economics and Finance*, 42(2), 352–368. <https://doi.org/10.1007/s12197-017-9422-x>
- Hamburger, M., & Keran, K. (1987). A stable demand for money function. *Contemporary Policy Issues*, 5, 34–40.
- Harris, L. (1990). Statistical properties of the Roll serial covariance Bid/Ask Spread estimator. *The Journal of Finance*, 45(2), 579–590. <https://doi.org/10.1111/j.1540-6261.1990.tb03704.x>
- Harris, R. D. F., & Tzavalis, E. (1999). Inference for unit roots in dynamic panels where the time dimension is fixed. *Journal of Econometrics*, 91(2), 201–226. [https://doi.org/10.1016/S0304-4076\(98\)00076-1](https://doi.org/10.1016/S0304-4076(98)00076-1)
- Harvey, C. R. (1988). The real term structure and consumption growth. *Journal of Financial Economics*, 22(2), 305–333. [https://doi.org/10.1016/0304-405X\(88\)90073-6](https://doi.org/10.1016/0304-405X(88)90073-6)

- Hasan, A., & Javed, M. T. (2009). An empirical investigation of the causal relationship among monetary variables and equity market returns. *The Lahore Journal of Economics*, 14(1), 115–137. <https://doi.org/10.35536/lje.2009.v14.i1.a5>
- Hasbrouck, J. (2009). Trading Costs and Returns for U.S. Equities: Estimating Effective Costs from Daily Data. *The Journal of Finance*. <https://doi.org/10.1111/j.1540-6261.2009.01469.x>
- Hayworth, S., & Abdullah, D. (1993). Macroeconomics of stock price fluctuations. *Quarterly Journal of Business and Economics*, 32(1), 50–67.
- Herrenbrueck, L. (2019). Frictional asset markets and the liquidity channel of monetary policy. *Journal of Economic Theory*, 181, 82–120. <https://doi.org/10.1016/j.jet.2019.02.003>
- Herwany, A., Satyakti, Y.-, & Wardhana, W. (2017). The impact of monetary policy on stock market liquidity and the business cycle in Indonesia. *SSRN Electronic Journal*. <https://doi.org/10.2139/ssrn.3030518>
- Ho, S. Y. (2019). Macroeconomic determinants of stock market development in South Africa. *International Journal of Emerging Markets*, 14(2), 322–342. <https://doi.org/10.1108/IJoEM-09-2017-0341>
- Ho, S. Y., & Njindan Iyke, B. (2017). Determinants of stock market development: A review of the literature. *Studies in Economics and Finance*, 34(1), 143–164. <https://doi.org/10.1108/SEF-05-2016-0111>
- Homa, K. E., & Jaffee, D. M. (1971). The supply of money and common stock prices. *The Journal of Finance*, 26(5), 1045–1066. <https://doi.org/10.1111/j.1540-6261.1971.tb01747.x>
- Hondroyiannis, G., Lolos, S., & Papapetrou, E. (2005). Financial markets and economic growth in Greece, 1986-1999. *Journal of International Financial Markets, Institutions and Money*, 15(2), 173–188. <https://doi.org/10.1016/j.intfin.2004.03.006>
- Hosseini, S. M., Ahmad, Z., & Lai, Y. W. (2011). The role of macroeconomic variables on stock market index in China and India. *International Journal of Economics and Finance*, 3(6), 233. <https://doi.org/10.5539/ijef.v3n6p233>
- Hou, H., & Cheng, S. Y. (2010). The roles of stock market in the finance-

- growth nexus: Time series cointegration and causality evidence from Taiwan. *Applied Financial Economics*, 20(12), 975–981. <https://doi.org/10.1080/09603101003724331>
- Hunjra, A. I., Chani, M. I., Ijaz, M. S., Farooq, M., & Khan, K. (2014). The impact of macroeconomic variables on stock prices in Pakistan. *Munich Personal RePEc Archive Paper No. 60791*. <http://mpa.ub.uni-muenchen.de/60791>
- Husain, F., & Mehmood, T. (1999). Monetary expansion and stock returns in Pakistan. *The Pakistan Development Review*, 38(4II), 769–776. <https://doi.org/10.30541/v38i4iipp.769-776>
- Huy, T. Q. (2016). The linkage between exchange rates and stock prices: Evidence from Vietnam. *Asian Economic and Financial Review*, 6(7), 363–373. <https://doi.org/10.18488/journal.aefr/2016.6.7/102.7.363.373>
- Ibrahim, M., & Musah, A. (2014). An econometric analysis of the impact of macroeconomic fundamentals on stock market returns in Ghana. *Research in Applied Economics*, 6(2), 47. <https://doi.org/10.5296/rae.v6i2.5146>
- Igbinsosa, S. ., & Uhunmwangho, M. (2019). Macroeconomic aggregates and stock market liquidity: Evidence from African stock markets. *International Journal of Economics and Financial Management*, 4(1), 18–27.
- Iheanacho, E. (2016). The impact of financial development on economic growth in Nigeria: An ARDL analysis. *Economies*, 4(4). <https://doi.org/10.3390/economies4040026>
- Im, K. S., Pesaran, M. H., & Shin, Y. (1997). Testing for unit roots in heterogeneous panels. *Mimeo*.
- Im, K. S., Pesaran, M. H., & Shin, Y. (2003). Testing for unit roots in heterogeneous panels. *Journal of Econometrics*, 115(1), 53–74.
- IMF. (2000). Monetary and financial statistics manual. In *Monetary and Financial Statistics Manual*. <https://doi.org/10.5089/9781589060296.049>
- Indangasi, J. (2017). The relationship between economic growth and stock market performance in Kenya. *Stratford Peer Reviewed Journals and Book Publishing Journal of Finance and Accounting*, 1(1), 27–41.

- Ioannides, D. (2005). The relationship between stock market returns and inflation: An econometric investigation using Greek data. *International Journal of Economics and Finance*, 910–916. <http://conferences.telecom-bretagne.eu/asmda2005/IMG/pdf/proceedings/910.pdf>
- Issahaku, H., Ustarz, Y., & Domanban, P. B. (2013). Macroeconomic variables and stock market returns in Ghana: Any causal link? *Asian Economic and Financial Review*, 3(8), 1044–1062. <http://aessweb.com/journal-detail.php?id=5002>
- Jain, A., Narayan, P. K., & Thomson, D. (2011). The relationship between exchange rates, interest rates and Australian bank returns. *Appl. Econ. Lett.*, 18, 967–972.
- Janssen, N., Potjagailo, G., & Wolters, M. H. (2019). Monetary policy during financial crises: Is the transmission mechanism impaired? *International Journal of Central Banking*, 15(4), 81–126.
- Jefferis, K. R., & Okeahalam, C. C. (2000). The impact of economic fundamentals on stock markets in Southern Africa. *Development Southern Africa*, 17(1), 23–51. <https://doi.org/10.1080/03768350050003398>
- Jieun, L., Doojin, R., & Ali, M. K. (2016). Monetary policy announcements, communication, and stock market liquidity. *Australian Economic Papers*. <https://doi.org/DOI: 10.1111/1467-8454.12069>
- Jonathan, O. O., & Oghenebrume, A. D. (2017). Impact of monetary policy on stock market prices in Nigeria. *Journal of Economics, Management and Trade*, 19(4), 1–11.
- Kamat, M. S., & Kamat, M. M. (2011). Does financial growth lead economic performance in India? Causality-cointegration using unrestricted Vector Error Correction models. *SSRN Electronic Journal*, 1–26. <https://doi.org/10.2139/ssrn.1069481>
- Kandir, S. Y. (2008). Macroeconomic variables, firm characteristics and stock returns: Evidence from Turkey. *International Research Journal of Finance and Economics*, 16(16), 35–45. <http://www.eurojournals.com/finance.htm%5Cnhttp://ezproxy.lib.mnash.edu.au/login?url=http://search.ebscohost.com/login.aspx?direct=true&db=ecn&AN=1230315&site=ehost-live&scope=site>

- Kang, S. H., Yoon, S.-M., Seong, □, & Yoon, M. (2013). Revisited return and volatility spillover effect in Korea *. *Korea and the World Economy*, 14(1), 121–145.
- Kao, C. (1999). Spurious regression and residual-based tests for cointegration in panel data. *Journal of Econometrics*, 90(1), 1–44. [https://doi.org/10.1016/S0304-4076\(98\)00023-2](https://doi.org/10.1016/S0304-4076(98)00023-2)
- Keister, T. (2019). The interplay between liquidity regulation, monetary policy implementation and financial stability. *Global Finance Journal*, 39, 30–38. <https://doi.org/10.1016/j.gfj.2018.01.013>
- Kennedy, K., & Nourzad, F. (2016). Exchange rate volatility and its effect on stock market volatility. *International Journal of Human Capital in Urban Management*, 1(1), 37–46.
- Keynes, J. M. (1930). A treatise on money. Two volumes. *Macmillan, London, 1965*.
- Khan, K., Qingyang, W., & Khurshid, A. (2017). Causal relationship between monetary policy and the stock market: A bootstrap rolling window approach. *Financial Markets, Institutions and Risks*, 1(4), 5–15. [https://doi.org/10.21272/fmir.1\(4\).5-15.2017](https://doi.org/10.21272/fmir.1(4).5-15.2017)
- Kim, S., & In, F. (2005). The relationship between stock returns and inflation: New evidence from wavelet analysis. *Journal of Empirical Finance*, 12(3), 435–444. <https://doi.org/10.1016/j.jempfin.2004.04.008>
- King, S. R. (1986). Monetary transmission: Through bank loans or bank liabilities? *Journal of Money, Credit and Banking*, 18(3), 290. <https://doi.org/10.2307/1992382>
- Kohn, D. L. (2009). Monetary policy and asset prices revisited. *Cato Journal*, 29(1), 31–44.
- Kolozsi, P. P. (2013). Monetary policy, interest groups, financial crisis. *Journal of Financial Economics*, 5(2), 35–55. <http://jfe.rochester.edu/>
- Koskei, L. (2021). Exchange rate fluctuations and the performance of Nairobi securities exchange market in Kenya during the Coronavirus pandemic. *International Journal of Business, Economics and Management*, 8(1), 1–9. <https://doi.org/10.18488/journal.62.2021.81.1.9>

- Kremers, J. J. M., Ericsson, N. R., & Dolado, J. J. (1992). The power of cointegration tests. *Oxford Bulletin of Economics and Statistics*, 54(3), 325–348. <https://doi.org/10.1111/j.1468-0084.1992.tb00005.x>
- Krueger, A. O. (1983). Exchange-rate determination. In *Cambridge: Cambridge University Press*.
- Kurihara, Y. (2017). Monetary policy and stock/foreign exchange market liquidity: The Japanese case. *Journal of Economics Library*, 4(1), 1–8. <http://www.kspjournals.org/index.php/JEL/article/view/1222>
- Kutas, G., & Végh, R. (2005). A Budapest likviditási mérték bevezetéséről. *Közgazdasági Szemle*, 686–711.
- Kuznets, S. (1955). Economic growth and income inequality. *The American Economic Review*, 1–28.
- Kwon, C. S., & Shin, T. S. (1999). Cointegration and causality between macroeconomic variables and stock market returns. *Global Finance Journal*, 10(1), 71–81. [https://doi.org/10.1016/S1044-0283\(99\)00006-X](https://doi.org/10.1016/S1044-0283(99)00006-X)
- Kyle, A. (1985). Continuous auctions and insider trading. *Econometrica*, 53(6), 1315 – 1335.
- Lakshmanasamy, T. (2021). Relationship between exchange rate and stock market volatilities in India. *International Journal of Finance Research*, 2(4), 244–259. <https://doi.org/10.47747/ijfr.v2i4.443>
- Lee, K., Pesaran, M. H., & Smith, R. (1997). Growth and convergence in a multi-country empirical stochastic solow model. *Journal of Applied Econometrics*, 12(4), 357–392. [https://doi.org/10.1002/\(SICI\)1099-1255\(199707\)12:4<357::AID-JAE441>3.0.CO;2-T](https://doi.org/10.1002/(SICI)1099-1255(199707)12:4<357::AID-JAE441>3.0.CO;2-T)
- Levin, A., Lin, C. F., & Chu, C. S. J. (2002). Unit root tests in panel data: Asymptotic and finite sample properties. *Journal of Econometrics*, 108(1), 1–24. [https://doi.org/10.1016/S0304-4076\(01\)00098-7](https://doi.org/10.1016/S0304-4076(01)00098-7)
- Lin, C. H. (2012). The comovement between exchange rate and stock prices in Asian emerging markets. *International Review of Economics and Finance*, 22(1), 161–172. <https://doi.org/10.1016/j.iref.2011.09.006>
- Loayza, N., & Schmidt-Hebbel, K. (2002). Monetary policy - Rules and transmission mechanisms. *Central Bank of Chile*.

- Lopez, L., & Weber, S. (2017). Testing for Granger causality in panel data. *Stata Journal*, 17(4), 972–984. <https://doi.org/10.1177/1536867X1801700412>
- Lütkepohl, H. (1993). Introduction to multiple time series. *Springer, Berlin*.
- Lybek, T., & Sarr, A. (2002). Measuring liquidity in financial markets. In *IMF Working Papers* (Vol. 02, Issue 232). <https://doi.org/10.5089/9781451875577.001>
- Mao, Y., & Wu, R. (2007). Does the stock market act as a signal for real activity? Evidence from Australia. *Economic Papers*, 26(2), 180–192. <https://doi.org/10.1111/j.1759-3441.2007.tb01015.x>
- Markellos, R. . (2002). Nonlinear dynamics in economics and finance. In *Working Paper 8/02 (Dept. of Management Science and Technology, Athens University of Economics and Business, Athens)*.
- Markellos, R. N. (1994). Nonlinear dynamics in economics and finance. In *Philosophical Transactions of the Royal Society of London. Series A: Physical and Engineering Sciences* (Vol. 346, Issue 1679). <https://doi.org/10.1098/rsta.1994.0020>
- Marozva, G. (2020). Stock market liquidity and monetary policy. *International Journal of Economics and Business Administration*, 8(2), 265–275. <https://doi.org/10.35808/ijeba/459>
- Martin, Č., Asli, D.-K., Erik, F., & Ross, L. (2012). Benchmarking financial systems around the world. In *Policy Research, The World Bank Financial and Private Sector Development Vice Presidency & Development Economics Vice Presidency* (Vol. 6175). <http://documents.worldbank.org/curated/en/868131468326381955/pdf/wps6175.pdf>
- Maskay, B. (2007). Analyzing the effect of change in money supply on stock prices. *The Park Place Economist*, 15(1), 72–97. <https://digitalcommons.iwu.edu/parkplace/vol15/iss1/16>
- Maysami, R. C., Howe, L. C., & Hamzah, M. A. (2005). Relationship between macroeconomic variables and stock market indices: Cointegration evidence from stock exchange of Singapore's All-S sector indices. *Jurnal Pengurusan*, 24, 47–77. <https://doi.org/10.17576/pengurusan-2005-24-03>
- Maysami, R. C., & Koh, T. S. (2000). A vector error correction model of

- the Singapore stock market. *International Review of Economics and Finance*, 9(1), 79–96. [https://doi.org/10.1016/S1059-0560\(99\)00042-8](https://doi.org/10.1016/S1059-0560(99)00042-8)
- Mbutor, O. M. (2007). The lending channel of monetary policy transmission in Nigeria; Vector Autoregressive (VAR) verification. *Central Bank of Nigeria; Economic and Financial Review*, 45(1), 57–77.
- Mc Cornac, D. C. (1991). Money and the level of stock market prices: Evidence from Japan. *Quarterly Journal of Business and Economics*, 30(4), 42–54. <http://www.jstor.com/stable/40473036%0AJSTOR>
- Meltzer, A. H. (1995). Monetary, credit and (other) transmission processes: A monetarist perspective. *Journal of Economic Perspectives*, 9(4), 49–72. <https://doi.org/10.1257/jep.9.4.49>
- Menaje, P. M. (2012). Impact of Selected Financial Variables on Share Price of Publicly Listed Firms in The Philippines. *American International Journal of Contemporary Research*, 2(9).
- Miseman, M. R., Ismail, F., Ahmad, W., Akit, F. M., Mohamad, R., & Mahmood, W. M. W. (2013). The impact of macroeconomic forces on the ASEAN stock market movements. *World Applied Sciences Journal*, 23(23), 61–66. <https://doi.org/10.5829/idosi.wasj.2013.23.eemcge.22012>
- Mishkin, F. (2006). The economics of money, banking, and financial markets. In (8th ed.). *Boston: Addison-Wesley*.
- Mishkin, F. S. (1990). The information in the longer maturity term structure about future inflation. *Quarterly Journal of Economics*, 105(3), 815–828. <https://doi.org/10.2307/2937901>
- Mishkin, F. S. (2010). Monetary policy strategy : Lessons from the Crisis. *October, 16755(May)*, 0–66. <https://doi.org/10.1037/0022-0663.92.1.191>
- Mishkin, F. S. (2013). The economics of money, banking, and financial markets. In *Columbia University, Pearson, Tenth Edition*.
- Mishkin, F. S. (2018). The transmission mechanism and the role of asset prices in monetary policy. *Monetary Policy Strategy*. <https://doi.org/10.7551/mitpress/7412.003.0006>
- Mishkin, F. S., Gordon, R. J., & Hymans, S. H. (1977). What depressed

- the consumer? The household balance sheet and the 1973-1975 recession. *Brookings Papers on Economic Activity*, 1977(1), 123–164. <https://doi.org/10.2307/2534258>
- Mishkin, Frederic. (2001a). Financial policies and the prevention of Financial Crises in emerging market countries. *National Bureau of Economic Research*. <https://doi.org/10.3386/w8087>
- Mishkin, Frederic. (2001b). Inflation targeting. *The Paper Was Prepared for Brian Vane Nad Howard Vine, An Encyclopedia of Macroeconomics*, Edward Elgar.
- Modigliani, F., & Cohn, R. A. (1979). Inflation, rational valuation, and the market. *Financial Analysts Journal*, 35(2), 24–44.
- Modigliani, Franco. (1971). Monetary policy and consumption: Linkages via interest rate and wealth effects in the FMP model. *Consumer Spending and Monetary Policy: The Linkages*, 9–84.
- Mody, A. (2004). What is an emerging market? In *IMF Working Papers* (Vol. 04, Issue 177). <https://doi.org/10.5089/9781451858907.001>
- Mohamadpour, B., Behravan, N., Espahbodi, S., & Karimi, R. (2012). An empirical study of relationship between monetary policy and stock market performance in Malaysia. *Australian Journal of Basic and Applied Sciences*, 6(12), 142–148.
- Mohapatra, S. M., & Rath, B. N. (2015). Do macroeconomic factors matter for stock prices in emerging countries? Evidence from panel cointegration and panel causality. *International Journal of Sustainable Economy*, 7(2), 140. <https://doi.org/10.1504/ijse.2015.068678>
- Mok, H. M. (1993). Causality of interest rate, exchange rate and stock prices at stock market open and close in Hong Kong. *Asia Pacific Journal of Management*, 10(2), 123–143. <https://doi.org/10.1007/BF01734274>
- Mukherjee, T. K., & Naka, A. (1995). Dynamic relations between macroeconomic variables and the Japanese stock market: An application of a Vector Error Correction Model. *Journal of Financial Research*, 18(2), 223–237. <https://doi.org/10.1111/j.1475-6803.1995.tb00563.x>
- Muktadir-al-Mukit, D. (2013). Effects of interest rate and exchange rate on volatility of market index at Dhaka stock exchange. *Journal of*

- Business and Technology (Dhaka)*, 7(2), 1–18.
<https://doi.org/10.3329/jbt.v7i2.16451>
- Musawa, N., & Mwaanga, C. (2017). The impact of commodity prices, interest rate and exchange rate on stock market performance: Evidence from Zambia. *Journal of Financial Risk Management*, 06(03), 300–313. <https://doi.org/10.4236/jfrm.2017.63022>
- Mustafa, K., Ahmed, R., & Siddiqui, A. A. (2013). Money supply and equity price movements in Pakistan. *European Journal of Business and Management*, 5(5), 146–156.
- Mutuku, C., & Ng'eny, K. L. (2014). Macroeconomic variables and the Kenyan equity market: A time series analysis. *Business and Economic Research*, 5(1), 1. <https://doi.org/10.5296/ber.v5i1.6733>
- Næs, R., Skjeltorp, J. A., & Ødegaard, B. A. (2011). Stock market liquidity and the business cycle. *Journal of Finance*, 66(1), 139–176. <https://doi.org/10.1111/j.1540-6261.2010.01628.x>
- Naik, P. K. (2013). Does stock market respond to economic fundamentals? Time-series analysis from Indian data. *Journal of Applied Economics and Business Research JAEBR*, 3(1), 34–50. <https://www.researchgate.net/publication/241687429>
- Nguyen, V.-H. (2019). Dynamics between exchange rates and stock prices: Evidence from developed and emerging markets. *The International Journal of Business and Finance Research*, 13(1), 73–84.
- Nieh, C. C., & Lee, C. F. (2001). Dynamic relationship between stock prices and exchange rates for G-7 countries. *Quarterly Review of Economics and Finance*, 41(4), 477–490. [https://doi.org/10.1016/S1062-9769\(01\)00085-0](https://doi.org/10.1016/S1062-9769(01)00085-0)
- Nordin, N., Nordin, S., & Ismail, R. (2014). The impact of commodity prices, interest rate and exchange rate on stock market performance: An empirical analysis from Malaysia. *Malaysian Management Journal*, 18, 39–52. <https://repo.uum.edu.my/id/eprint/16574/1/4mmj18.pdf>
- Nyanaro, E., & Elly, D. (2017). The relationship between stock market performance and economic growth in the East African community. *African Development Finance Journal*, 1(1), 110–132.
- O'Hara, M. (2004). Liquidity and financial market stability. In *National*

Bank of Belgium (Vol. 55).

- Octavio, F.-A., Martin, G., Martin, L., & Georg, P. (2013). Does monetary policy determine stock market liquidity? New evidence from the euro zone. *Journal of Empirical Finance*, 21(1), 54–68. <https://doi.org/10.1016/j.jempfin.2012.12.008>
- Okpara, G. C. (2010). Monetary policy and stock market returns: Evidence from Nigeria. *Journal of Economics*, 1(1), 13–21. <https://doi.org/10.1080/09765239.2010.11884920>
- Oluwole, F. O. (2014). Globalization and stock Mmarket growth in Nigeria. *European Scientific Journal*, 10(31), 317. <https://ejournal.org/index.php/esj/article/view/4587%0Ahttps://search.ebscohost.com/login.aspx?direct=true&db=edb&AN=101975285&site=eds-live>
- Omodero, C. O., & Mlangi, S. (2019). Evaluation of the impact of macroeconomic variables on stock market performance in Nigeria. *Business and Management Studies*, 5(2), 34. <https://doi.org/10.11114/bms.v5i2.4208>
- Onyekachi Onyele, K., B. Ikwuagwu, E., & Onyekachi-Onyele, C. (2020). Macroeconomic policies and stock market liquidity: Evidence from Nigeria. *Economy*, 7(1), 25–35. <https://doi.org/10.20448/journal.502.2020.71.25.35>
- Osamwonyi, I. O., & Evbayiro-Osagie, E. I. (2012). The relationship between macroeconomic variables and stock market index in Nigeria. *Journal of Economics*, 3(1), 55–63. <https://doi.org/10.1080/09765239.2012.11884953>
- Oscar, T. (2010). Panel data analysis fixed and random effects using Stata. *Data and Statistical Services*, 3(December), 1–40.
- Oskooe, S. A. P. (2010). Emerging stock market performance and economic growth. *American Journal of Applied Sciences*, 7(2), 265–269. <https://doi.org/10.3844/ajassp.2010.265.269>
- Österholm, P. (2016). The long-run relationship between stock prices and GDP in Sweden. *Economic Notes*, 45(2), 283–297. <https://doi.org/10.1111/ecno.12057>
- Pan, L., & Mishra, V. (2018). Stock market development and economic growth: Empirical evidence from China. *Economic Modelling*, 68, 661–673. <https://doi.org/10.1016/j.econmod.2017.07.005>

- Park, H. M. (2011). Practical guides to panel data modeling: A step-by-step analysis using stata. In *Tutorial Working Paper. Graduate School of International Relations, International University of Japan*.
- Parsva, P., & Lean, H. H. (2011). The analysis of relationship between stock prices and exchange rates: Evidence from six Middle Eastern financial markets. *International Research Journal of Finance and Economics*, 66, 157–171.
- Patrick, H. T. (1966). Financial development and economic growth in underdeveloped countries. *Economic Development and Cultural Change*, 14, 174–189.
- Paulo, P. da S. (2013). Modeling and forecasting liquidity using Principal Component Analysis and Dynamic Factor models: An Illiquidity composite indicator proposal. In *Comissão Do Mercado De Valores Mobiliários (CMVM) (Vol. 3)*.
- Pearce, D. K., & Roley, V. V. (1985). Stock prices and economic news. *The Journal of Business*, 58(1), 49–67. <https://doi.org/10.1086/296282>
- Pedroni, P. (1999). Critical values for cointegration tests in heterogeneous panels with multiple regressors. *Oxford Bulletin of Economics and Statistics*, 61(SUPPL.), 653–670. <https://doi.org/10.1111/1468-0084.61.s1.14>
- Pedroni, P. (2004). Panel cointegration: Asymptotic and finite sample properties of pooled time series tests with an application to the PPP hypothesis. *Econometric Theory*, 20(3), 597–625. <https://doi.org/10.1017/S0266466604203073>
- Pesaran, M. H. (2004). General diagnostic tests for cross section dependence in panels. In *CESifo Working Paper Series, No. 1229, IZA Discussion Paper No. 1240*.
- Pesaran, M. Hashem. (2007). A simple panel unit root test in the presence of cross-section dependence. *Journal of Applied Econometrics*, 22(2), 265–312. <https://doi.org/10.1002/jae.951>
- Pesaran, M. Hashem, Shin, Y., & Smith, P. R. (1999). Pooled mean group estimation of dynamic heterogeneous panels. *Journal of the American Statistical Association*, 94(446), 621–634.
- Pesaran, M.H. (2021). General diagnostic tests for cross section dependence in panels. In *SSRN Electronic Journal (Vol. 1229)*.

<https://doi.org/10.2139/ssrn.572504>

- Pethe, A., & Karnik, A. (2000). Do Indian stock markets matter? Stock market indices and macroeconomic variables. *Economic and Political Weekly*, 35(5), 349–356.
- Pícha, V. (2017). Effect of money supply on the stock market. *Acta Universitatis Agriculturae et Silviculturae Mendelianae Brunensis*, 65(2), 465–472. <https://doi.org/10.11118/actaun201765020465>
- Pilinkus, D., & Boguslauskas, V. (2009). The short-run relationship between stock market prices and macroeconomic variables in Lithuania: An application of the impulse response function. *Engineering Economics*, 5(65), 26–34. <https://doi.org/10.5755/j01.ee.65.5.11607>
- Pradhan, R. P., Arvin, M. B., & Ghoshray, A. (2015). The dynamics of economic growth, oil prices, stock market depth, and other macroeconomic variables: Evidence from the G-20 countries. *International Review of Financial Analysis*, 39, 84–95. <https://doi.org/10.1016/j.irfa.2015.03.006>
- PwC. (2015). *Global financial markets liquidity study*. <https://www.pwc.se/sv/pdf-reports/global-financial-markets-liquidity-study.pdf>
- Rahman, M. L., & Uddin, J. (2009). Dynamic relationship between stock prices and exchange rates: Evidence from three South Asian countries. *International Business Research*, 2(2), 5–14. <https://doi.org/10.5539/ibr.v2n2p167>
- Ramey, V. (1993). How important is the Credit channel in the transmission of monetary policy? *Carnegie–Rochester Conference Series on Public Policy*, 39, 1–46.
- Rapach, D. E. (2001). Macro shocks and real stock prices. *Journal of Economics and Business*, 53(1), 5–26. [https://doi.org/10.1016/s0148-6195\(00\)00037-0](https://doi.org/10.1016/s0148-6195(00)00037-0)
- Rashid, A. (2008). Macroeconomic variables and stock market performance: Testing for dynamic linkages with a known structural break. *Savings and Development*, 32(1), 77–102.
- Ratanapakorn, O., & Sharma, S. C. (2007). Dynamic analysis between the US stock returns and the macroeconomic variables. *Applied Financial Economics*, 17(5), 369–377.

<https://doi.org/10.1080/09603100600638944>

- Raymond, K. (2009). Is there a long run relationship between stock prices and monetary variables? Evidence from Jamaica. *Bank of Jamaica, Financial Stability Department, Kingston*.
- Rehman, I. U., Mahdzan, N. S., & Zainudin, R. (2016). Is the relationship between macroeconomy and stock market liquidity mutually reinforcing? Evidence from an emerging market. *International Journal of Monetary Economics and Finance*, 9(3), 294–316. <https://doi.org/10.1504/IJMEF.2016.078405>
- Rioja, F., & Valev, N. (2014). Stock markets, banks and the sources of economic growth in low and high income countries. *Journal of Economics and Finance*, 38(2), 302–320. <https://doi.org/10.1007/s12197-011-9218-3>
- Ritter, J. R. (2005). Economic growth and equity returns. *Pacific Basin Finance Journal*, 13(5), 489–503. <https://doi.org/10.1016/j.pacfin.2005.07.001>
- Robinson, J. (1952). The generalization of the general theory. In *In Rate of Interest and Other Essays*. London, UK: Macmillan.
- Romer, C. D., Romer, D. H., Goldfeld, S. M., & Friedman, B. M. (1990). New evidence on the monetary transmission mechanism. *Brookings Papers on Economic Activity*, 1990(1), 149–198. <https://doi.org/10.2307/2534527>
- Saganga, M. K. (2020). Stock market development and economic growth in Tanzania: An ARDL and bound testing approach. *Review of Economics and Political Science*, 5(3), 187–206.
- Sahu, T. N., & Pandey, K. D. (2020). Money supply and equity price movements during the liberalized period in India. *Global Business Review*, 21(1), 108–123. <https://doi.org/10.1177/0972150918761084>
- Santos, A. S. dos, Neto, A. R., de Araujo, E. C., de Oliveira, L., & Abrita, M. B. (2013). Interaction between macroeconomics variables and IBOVESPA, the Brazilian stock market's index. *Transnational Corporations Review*, 5(4), 81–95. <https://doi.org/10.1080/19186444.2013.11658374>
- Schumpeter, J. A. (1911). The theory of economic development. In *Cambridge, MA, USA: Harvard University Press*.

- Sechel, Ioana-Cristina, Gheorghe, C. (2014). Characteristics of the emerging market economies - BRICS, from the perspective of stock exchange markets. *Annals of the University of Oradea, Economic Science Series*, 23(1), 40–49. <http://www.redibw.de/db/ebsco.php/search.ebscohost.com/login.aspx?direct=true&db=buh&AN=97635552&lang=de&site=ehost-live>
- Sekaran, U. (2013). Research methods for business. Research methods for business (Vol. 65). In Wiley.
- Sekaran, U., & Bougie, R. (2013). Research methods for business: A skill-building approach. *6th Edition*, Wiley, New York.
- Sellin, P. (2001). Monetary policy and the stock market: Theory and empirical evidence. *Journal of Economic Surveys*, 15(4), 491–541. <https://doi.org/10.1111/1467-6419.00147>
- Sensoy, A. (2016). Commonality in liquidity: Effects of monetary policy and macroeconomic announcements. *Finance Research Letters*, 16, 125–131. <https://doi.org/10.1016/j.frl.2015.10.021>
- Seong, L. (2013). Transmission of monetary policy to the stock exchange: Further evidence from Singapore. *Interdisciplinary Journal of Contemporary Research in Business*, 5, 384–392.
- Shen, P., & Starr, R. M. (2002). Market makers' supply and pricing of financial market liquidity. *Economics Letters*, 1. <https://doi.org/10.2139/ssrn.256105>
- Siegel, J. (1998). Stocks for the long run. *McGraw Hill*, New York.
- Silviyani, N. L. N. T., Sujana, E., & Adiputra, I. M. P. (2016). Pengaruh Likuiditas Perdagangan Saham Dan Kapitalisasi Pasar Terhadap Return Saham Perusahaan Yang Berada Pada Indeks Lq45 Di Bursa Efek Indonesia Periode Tahun 2009-2013. *E-Journal SI Ak Universitas Pendidikan Ganesha*, 2(1), 1–11.
- Simon, Y. (1997). Encyclopedie des marches financiers. *Paris: Editura Economica*.
- Sinha, R., Mohapatra, D. D. R., & Das, D. T. (2021). Does interest rate changes have an impact on Nifty returns in long run? A Cointegration perspective. *Nat. Volatiles & Essent. Oils*, 8(4), 1338–1350.
- Širuček, M. (2013). Impact of money supply on stock bubbles. *Acta*

Universitatis Agriculturae et Silviculturae Mendelianae Brunensis, 61(7), 2835–2842. <https://doi.org/10.11118/actaun201361072835>

- Smimou, K. (2014). Consumer attitudes, stock market liquidity, and the macro economy: A Canadian perspective. *International Review of Financial Analysis*, 33, 186–209. <https://doi.org/10.1016/j.irfa.2014.02.009>
- Smyth, R., & Nandha, M. (2003). Bivariate causality between exchange rates and stock prices in South Asia. *Applied Economics Letters*, 10(11), 699–704. <https://doi.org/10.1080/1350485032000133282>
- Sohail, N., & Hussain, Z. (2009). Long-run and short-run relationship between macroeconomic variables and stock prices in Pakistan: The case of Lahore Stock Exchange. *Pakistan Economic and Social Review*, 47(2), 183–198. <https://doi.org/10.2307/25825351>
- Sprinkel, B. W. (1964). Money and stock prices. In *Homewood, IL: Richard Darwin*.
- Srinivasan, P. (2011). Causal nexus between stock market return and selected macroeconomic variables in India: Evidence from the National Stock Exchange (NSE). *IUP Journal of Financial Risk Management*, 8(4), 7.
- Stoll, H. (2000). Presidential address: Friction. *The Journal of Finance*, 55(4), 1479–1514.
- Subburayan, B., & Srinivasan, V. D. (2014). The effects of macroeconomic variables on CNX Bankex Returns: Evidence from Indian stock market. *International Journal of Management & Business Studies*, 4(2).
- Suhaibu, I., Harvey, S. K., & Amidu, M. (2017). The impact of monetary policy on stock market performance: Evidence from twelve (12) African countries. *Research in International Business and Finance*, 42, 1372–1382. <https://doi.org/10.1016/j.ribaf.2017.07.075>
- Sui, L., & Sun, L. (2016). Spillover effects between exchange rates and stock prices: Evidence from BRICS around the recent global financial crisis. *Research in International Business and Finance*, 36, 459–471. <https://doi.org/10.1016/j.ribaf.2015.10.011>
- Syamala, S. R., Wadhwa, K., & Goyal, A. (2017). Determinants of commonality in liquidity: Evidence from an order-driven emerging market. *North American Journal of Economics and Finance*, 42, 38–

52. <https://doi.org/10.1016/j.najef.2017.07.003>

- Tang, H. P., Habibullah, M. S., & Puah, C. H. (2007). Stock market and economic growth in selected Asian countries. *European Journal of Economics, Finance and Administrative Sciences*, 7, 43–52.
- Taylor, J. B. (1995). The monetary transmission mechanism: An empirical framework. *Journal of Economic Perspectives*, 9(4), 11–26.
- Thaddeus, K. J., Ngong, C. A., Nnecka, U. J., Nubong, N. M., Ibe, G. I., Chinyere C. O., & Onwumere, J. U. J. (2022). Stock market development and economic growth in sub-Saharan Africa (1990–2020): An ARDL approach. *Journal of Economic and Administrative Sciences*. <https://doi.org/10.1108/jeas-04-2021-0075>
- Thornton, D. L. (1994). Financial innovation deregulation and the “Credit view” of monetary policy. *Review*, 76(1), 31–49. <https://doi.org/10.20955/r.76.31-49>
- Tiwari, A. K., Dar, A. B., Bhanja, N., Arouri, M., & Teulon, F. (2015). Stock returns and inflation in Pakistan. *Economic Modelling*, 47, 23–31. <https://doi.org/10.1016/j.econmod.2014.12.043>
- Tripathi, V., & Kumar, A. (2015). Relationship between inflation and stock returns - Evidence from BRICS markets using Panel Cointegration test. *International Journal of Accounting and Financial Reporting*, 1(1), 647. <https://doi.org/10.5296/ijaf.v4i2.6671>
- Tripathi, V., & Kumar, A. (2016). Impact of financial crisis on the relationship between aggregate stock returns and macroeconomic factors in BRICS stock markets. *Journal of Economic Policy & Research*, 12(1), 2–18.
- Tripathy, N. (2011). Causal relationship between macroeconomic indicators and stock market in India. *Asian Journal of Finance & Accounting*, 3(1), 312–319. <https://doi.org/10.5296/ajfa.v3i1.633>
- Valcarcel, V. J. (2012). The dynamic adjustments of stock prices to inflation disturbances. *Journal of Economics and Business*, 64(2), 117–144. <https://doi.org/10.1016/j.jeconbus.2011.11.002>
- Van Nieuwerburgh, S., Buelens, F., & Cuyvers, L. (2006). Stock market development and economic growth in Belgium. *Explorations in Economic History*, 43(1), 13–38. <https://doi.org/10.1016/j.eeh>

2005.06.002

- Váradı, K. (2012). *Liquidity risk on stock markets*. Corvinus University of Budapest.
- Vazakıdıs, A., & Adamopoulos, A. (2009). Stock market development and economic growth. *American Journal of Applied Sciences*, 6(11), 1933–1941. <https://doi.org/10.3844/ajassp.2009.1932.1940>
- Wang, X. (2010). The relationship between stock market volatility and macroeconomic volatility: Evidence from China. *International Research Journal of Finance and Economics*, 49(2), 156–167. <https://doi.org/10.2139/ssrn.1888073>
- Westerlund, J. (2007). Testing for error correction in panel data. *Oxford Bulletin of Economics and Statistics*, 69(6), 709–748. <https://doi.org/10.1111/j.1468-0084.2007.00477.x>
- Wongbangpo, P., & Sharma, S. C. (2002). Stock market and macroeconomic fundamental dynamic interactions: ASEAN-5 countries. *Journal of Asian Economics*, 13(1), 27–51. [https://doi.org/10.1016/S1049-0078\(01\)00111-7](https://doi.org/10.1016/S1049-0078(01)00111-7)
- Wyss, R. Von. (2004). Measuring and predicting liquidity in the stock market1. *PhD Dissertation*, 2899, 211.
- Yong, T., Yong, L., Jie, X., Fei, Z., & Yi-Cheng, Z. (2013). Impact of monetary policy changes on the Chinese monetary and stock markets. *Physica A: Statistical Mechanics and Its Applications*, 392(19), 4435–4449.
- Zakaria, Z., & Shamsuddin, S. (2012). Empirical evidence on the relationship between stock market volatility and macroeconomics volatility in Malaysia. *Journal of Business Studies Quarterly*, 4(2), 61–71.
- Zalgıryte, L., Guzavicius, A., & Tamulis, V. (2014). Stock market and economic growth in the U.S. & France: Evidence from stock market sector indices. *Engineering Economics*, 25(1), 47–53. <https://doi.org/10.5755/j01.ee.25.1.1985>
- Zhao, H. (2010). Dynamic relationship between exchange rate and stock price: Evidence from China. *Research in International Business and Finance*, 24(2), 103–112. <https://doi.org/10.1016/j.ribaf.2009.09.001>

PUBLICATIONS RELATED/ NOT RELATED TO THE TOPIC OF THE DISSERTATION

Publications related to the dissertation

- Hoang Ton, U. T., & Tatay, T. (2022). Monetary policy lessons learned from 2007-2009 Financial Crisis in SouthEast Asia. *Selye E-Studies, Faculty of Economics, J. Selye University, Slovakia, 13(2)*, 13–35.
- Hoang Ton, U. T., & Tatay, T. (2021). Monetary policy and stock market liquidity in emerging market economies: A literature review. *Regional and Business Studies, 13(2)*, 55–68. <https://doi.org/10.33568/rbs.2916>
- Hoang Ton, U. T., & Tatay, T. (2019). Attracting foreign capital to Viet Nam's banking sector. *Gazdaság És Társadalom, 12(2)*, 23–41. <https://doi.org/10.21637/gt.2019.2.02>

Publications not related to the dissertation

Books

- Hoang Ton, U. T. (2022). Brand, culture and employee engagement: The study of Bosch Group. In *Organizational behaviour and leadership theory in practice, Kaposvár, Hungary: Magyar Agrár-és Élettudományi Egyetem Kaposvári Campus* (pp. 33–45).

Full papers in conference proceedings

- Hoang Ton, U. T. (2021). Monetary policy effects on stock market liquidity during Financial Crisis and Non-crisis period: A literature review. *The 15th Annual International Conference on Economics*

and Business: Challenges in the Carpathian Basin, Sapientia Hungarian University of Transylvania, Romania, 1–18.

Hoang Ton, U. T., & Tatay, T. (2018). Applying inflation targeting for monetary policy framework in Vietnam: Challenge and Response. *The 3rd Business and Entrepreneurial Economics Conference 2018, University of Zagreb, Faculty of Economics and Business, Sibenik, Croatia, 1–17.*

Tatay, T., & Hoang Ton, U. T. (2017). Kockázat, kockázatkezelés, értékpapírosítás és annak makrogazdasági hatásai. *Kautz Szakkollégiumi Konferencia, Széchenyi István University, 1–24.*

Hoang Ton, U. T., & Tatay, T. (2017). The relationship between corporate social responsibility and corporate financial performance. *The 5th International Scientific Correspondence Conference on “Legal, Economic, Managerial and Environment Aspects of Performance Competencies by Local Authorities”, Slovak University of Agriculture in Nitra, Slovakia, 1–12.*

Abstracts in Conference proceedings

Hoang Ton, U. T. (2020). Effects of monetary policy on stock market liquidity: A review. *ATLAS 7th International Social Sciences Congress, Tomori Pal College, Budapest, Hungary, 1.*

Hoang Ton, U. T., & Tatay, T. (2018). Stock market seasonal effects: Evidence from emerging market economies. *The 3rd International Young Researcher Scientific Conference on “Sustainable Regional Development - Challenges of Space and Society in the 21st Century”, Szent István University, Gödöllő, Hungary, 1.*

CURRICULUM VITAE

Personal information

First name / Surname **HOÀNG TÔN THANH UYÊN (Uyen Thanh HOANG TON)**
Nationality Vietnamese
Date of birth December 19th, 1978

Education and training

Date September 2017 - now

Title of qualification awarded ***PhD Student in Finance***

Name of awarding institution Doctoral School of Management and Organization Science, MATE Kaposvár Campus, Hungarian University of Agriculture and Life Sciences, Hungary.

Date October 2003 - December 2006

Title of qualification awarded ***Master of Business Administration***

Name of awarding institution The University of Danang, Da Nang City, Vietnam.
Graduated with an excellent mark of Thesis.

Date September 1996 - July 2000

Title of qualification awarded ***Bachelor of Economics in Banking***

Name of awarding institution Danang University of Economics, The University of Danang, Da Nang City, Vietnam.
Graduated with an excellent mark of Thesis.

Work experience

Date May 2010 - now

Employer name Faculty of Finance and Banking
University of Finance - Marketing, Ho Chi Minh City, Vietnam.

Occupation or position held ***Lecturer in Finance - Currency***

Date February 2007 - April 2010

Employer name Division for Public Information and Taxpayer Assistance
The Provincial Tax Office of Da Nang City, Vietnam.

Occupation or position held ***Taxation official***

Date September 2003 - 2006

Employer name Department of Finance and Banking
The Danang College of Economics - Planning, Da Nang City, Vietnam.

Occupation or position held ***Lecturer in Banking***

Date 2000 - August 2003

Employer name The Danang Representative Office
Hoang Ha packing limited company, Ho Chi Minh City, Vietnam.

Occupation or position held ***General coordination official***

CHAPTER 2: APPENDICES

APPENDIX 2.A. Definition of stock market liquidity measures

1. Resiliency (*ReM*): Price-related liquidity measures: The ability to buy or to sell a certain amount of an asset *with influence on the quoted price*. (Wyss, 2004)

Market-Efficiency Coefficient (MEC): (Lybek & Sarr, 2002 and Paulo, 2013)

$$MEC = \frac{Var(R_t)}{T \times Var(r_t)}$$

$Var(R_t)$: Variance of long-period returns.
 $Var(r_t)$: Variance of short-period returns.
 T : Number of short-periods in each longer period.

2. Depth (*DeM*): Volume-related liquidity measures: The ability to buy or to sell a certain amount of an asset *without influence on the quoted price*. (Wyss, 2004)

- *Trading volume (Q_t):* (Wyss, 2004). Trading volume for time t-1 until time t is calculated as follows:

$$Q_t = \sum_{i=1}^{N_t} q_i$$

N_t : The number of trades between t-1 and t.
 q_i : The number of shares of trade i.

The average trade size is strongly influenced by the institutional frameset.

- *Turnover (V_t):* (Wyss, 2004). Like the trading volume, turnover (V_t) has to be calculated for a specific time interval:

$$V_t = \sum_{i=1}^{N_t} p_i \cdot q_i$$

p_i : The price of trade i.
 N_t : The number of trades between t-1 and t.

3. Tightness (*TiM*): Spread-related liquidity measures: The ability to buy and to sell an asset *at about the same price* at the same time. (Wyss, 2004)

- *Log Relative spread of log prices*: The logarithms of the log return of an asset. (**LogSrellog_t**) (Wyss, 2004)

$$\text{LogSrellog}_t = \ln(\text{Srellog}_t) = \ln\left(\ln\left(\frac{p_t^A}{p_t^B}\right)\right)$$

p_t^A : The lowest Ask price.
 p_t^B : The highest Bid price.
 Srellog_t : Relative spread of log prices.

LogSrellog_t is applied for generating “better” distributions of the spread measure. The log relative spread of log prices is much more symmetrically distributed and is therefore easier to approximate by a normal distribution.

- *Effective spread (Seff_t)*: (Wyss, 2004)

$$\text{Seff}_t = |p_t - p_t^M|$$

p_t : The last traded price before time t .
 p_t^M : The mid price $p_t^M = \frac{p_t^A + p_t^B}{2}$

4. Immediacy (Imm): Time-related liquidity measures: The ability to achieve a transaction immediately at the prevailing price. (Wyss, 2004)

- *Number of transactions per time unit (N_t)*: (Wyss, 2004). Like the trading volume, the number of trades is a widely used liquidity measure. It counts the number of trades between $t-1$ and t .

- *Frequency of transactions (n_t)*: (Váradi, 2012)

$$n_t = \frac{N}{T}$$

N: The number of transactions during a given T interval.

5. Diversity (DiM): The market investors’ homogeneity according to motivation, size, information and home country or foreign residency. *The Herfindahl-Hirschman index (HHI)*: Concentration of market participants is known as a good indirect indicator to measure market liquidity. (Váradi, 2012)

$$\text{HHI} = \sum_{i=1}^N z_i^2$$

Z: A particular market participant’s relative market share.
N: The number of market participants.
In case of lack of concentration, i.e. if all the market actors have the same share of the total value, then $\text{HHI} = 1/N$.

APPENDIX 2.B. Definition of monetary policy measures

1. Real interest rate (*INRr*): The real interest rate is not considered itself as a policy control variable but rather the output of policies (except in financial systems that are entirely indexed). The real interest rate measures the cost of capital in an economy and is an essential factor in any economy. Thus, a reduction in the real interest rate will cause an increase in the present value of capital and durable consumer goods and increase the ratio of the market value to asset value (Mbutor, 2007).

2. Money base (*MB*): The Monetary Base (or Money Base) comprises Central Bank liabilities that support the expansion of broad money and credit. The monetary base is sometimes called high-powered money because changes in the monetary base usually lead to more enormous changes in money and credit than the changes in the monetary base (IMF, 2000). The rolling twelve-month growth rate of money base MB_t as follows:

$$MB_t = \frac{MB_t - MB_{t-12}}{MB_{t-12}} \times 100$$

3. Exchange rate (*EXR*): The exchange rate can be clarified as the cost of monetary standards relating to other money (Krueger, 1983).

4. Real GDP growth rate (*GDP_r*): GDP growth rate is the rate at which the overall level of economic activities in an economy changes with time. High economic activity in a country results in higher incomes, which leads to higher investments and thus an increase in stock returns (Mishkin, 2001). Real GDP is utilised instead of nominal GDP because real GDP values the economy's total output measured at constant prices. Hence, real GDP changes if the quantities produced change from year to year. Theoretical literature contends that real GDP should have a

significant positive influence on the performance of most stock indices and have its magnitude of impact, which should vary across stock indices.

5. Inflation rate (CPI): CPI is well-known utilised for measuring inflation rate in each country, which reflects the percentage change in the general price of a basket of goods and services consumed by households. The inflation rate is known as an intermediate MOP target even though it is not a MOP tool, and most Central Bank usually implements it to achieve price stability for maintaining low inflation (Aziza, 2012).

6. The Treasury bill rate (TBR): Treasury bills are the least risky (Elton & Gruber, 1995) but play a unique role in financial theory because they have no risk of default in addition to concise term maturities. Treasury bill rates are usually the lowest of rates within the economy.

APPENDIX 2.C. The list of major stock exchanges in seven selected EMEs

Table 2.2. The list of major stock exchanges in seven selected EMEs

SMCode	Country	Major stock market	Location	Website
1	China	Shanghai Stock Exchange	Shanghai, China	http://www.sseinitiative.org/fact-sheet/sse/
2	India	National Stock Exchange of India	Mumbai, India	http://www.sseinitiative.org/fact-sheet/nse/
3	Mexico	Bolsa Mexicana de Valores	Mexico City, Mexico	http://www.sseinitiative.org/data/bmv/
4	Russian Federation	Moscow Exchange	Moscow, Russian Federation	http://www.sseinitiative.org/data/moex/
5	Turkey	Borsa Istanbul	Istanbul, Turkey	http://www.sseinitiative.org/data/bist/
6	Indonesia	Indonesia Stock Exchange (IDX)	Jakarta, Indonesia	https://sseinitiative.org/stock-exchange/idx/
7	Poland	Warsaw Stock Exchange	Warsaw, Poland	https://sseinitiative.org/stock-exchange/gpw/

Source: <http://www.sseinitiative.org/>

Note: SMCode is used to identified each country (each stock market) in this study (e.g. 1 = China).

APPENDIX 2.D. Description of the seven selected stock exchanges

China:

The Shanghai Stock Exchange (SSE) was founded on Nov. 26th, 1990 and commenced operations on Dec. 19th. It is a membership institution directly governed by the China Securities Regulatory Commission (CSRC). The SSE bases its development on the principle of “legislation, supervision, self-regulation and standardization” to create a transparent, open, safe and efficient marketplace. The SSE endeavours to realize various functions: providing marketplace and facilities for securities trading; formulating business rules; accepting and arranging listings; organizing and monitoring securities trading; regulating members and listed companies; managing and disseminating market information.

India:

The National Stock Exchange (NSE) is India’s leading stock exchange covering various cities and towns. Leading institutions set up NSE to provide a modern, fully automated screen-based trading system with a national reach. The Exchange has brought about unparalleled transparency, speed & efficiency, safety and market integrity. It has set up facilities that serve as a model for the securities industry in terms of systems, practices and procedures. The NSE has played a catalytic role in reforming the Indian securities market in microstructure, market practices and trading volumes.

Mexico:

The Mexican Stock Exchange (Bolsa Mexicana de Valores) - the BMV Group is a fully integrated Exchange Group that operates cash, listed derivatives and OTC markets for multiple asset classes, including equities, fixed income and exchange-traded funds, custody, clearing and

settlement facilities and data products for the local and international financial community. The BMV is the second-largest stock exchange in Latin America, with a total market capitalisation of over US\$ 530 billion.

Russian Federation:

Moscow Exchange is Russia's largest securities exchange group. Established on 19 December 2011 with the merger of Moscow Interbank Currency Exchange (MICEX) Group (created in 1992) and Russian Trading System (RTS) Group (1995), it ranks among the world's top 20 exchanges by trading volume and a total market cap of shares traded top 10 derivatives exchanges. Its participants enjoy state of the art, hi-tech infrastructure to trade stocks, bonds, currency, fund shares, exchange-traded funds (ETFs), commodities (grain, gold, silver), and derivatives, including OTC.

Turkey:

Following the enactment of the Capital Markets Law at the end of 2012, Borsa İstanbul A.Ş. was founded due to the demutualization of the Istanbul Stock Exchange, horizontal integration of the exchanges of Turkey trading various asset classes and their merger under the roof of Borsa İstanbul. Currently, Borsa İstanbul is the only licensed operator of capital markets in Turkey, regulated and supervised by the Capital Markets Board of Turkey, Turkish capital markets regulator. Borsa İstanbul provides a fair, transparent, and efficient environment for the trading of a wide variety of securities, including equities, exchange-traded funds, warrants, certificates, government bonds, Sukuk, corporate bonds, repo and reverses repo agreements, foreign securities (Turkish Treasury Eurobonds), derivatives and selected commodities. Borsa İstanbul is aiming to be the leading integrated marketplace bringing together investors and ideas, creating a marketplace that gives investors stability

and confidence in their investment transactions, to promote a diverse business incorporating both international and Islamic finance products, to embrace the digital transformation and innovation, and to facilitate economic growth.

Indonesia:

The Indonesia Stock Exchange (IDX) is a nonprofit Self-regulatory Organization (SRO). The IDX operates under the supervision of Indonesia Financial Services Authority (Otoritas Jasa Keuangan). As the only stock exchange in Indonesia, the IDX consistently promotes Indonesia Capital Market integrity and ensures that securities trading activities are exercised in an orderly, fair and efficient manner. The IDX's headquarter is in Jakarta, the capital city of Indonesia. To ensure financial iteration is spreading across Indonesia, The IDX has 29 Representatives Offices and 412 Investment Galleries.

Poland:

The Warsaw Stock Exchange (WSE) started operation in 1991 as a company held 100% by the State Treasury. In 2010, the State Treasury arranged a public offering of WSE shares; as a result, shares of the Exchange were newly listed on the WSE Main Market on 9 November 2010. The WSE is the largest national financial instruments exchange in Central and Eastern Europe¹ and one of the fastest-growing exchanges in Europe. The Group offers a wide range of products and services within its trading markets of equity, derivatives, debt and structured products, electricity, natural gas, property rights, clearing of transactions, operation of the Register of Certificates of Origin of electricity and sale of market data. As of 31 December 2013, the WSE was the leader in the CEE Region in terms of capitalisation of listed companies, the value of turnover in shares and the volume of turnover in derivatives. The share of

WSE in trading in shares in the Region increased from 54.3% in 2012 to 58.5% in 2013. Furthermore, the electricity market comprised of the spot and the forward market operated by the Polish Power Exchange (“PolPX”) was the largest as measured by the volume of trade in 2013 in the CEE Region.

CHAPTER 3: APPENDICES

APPENDIX 3.A. Transmission mechanisms of monetary policy and stock market

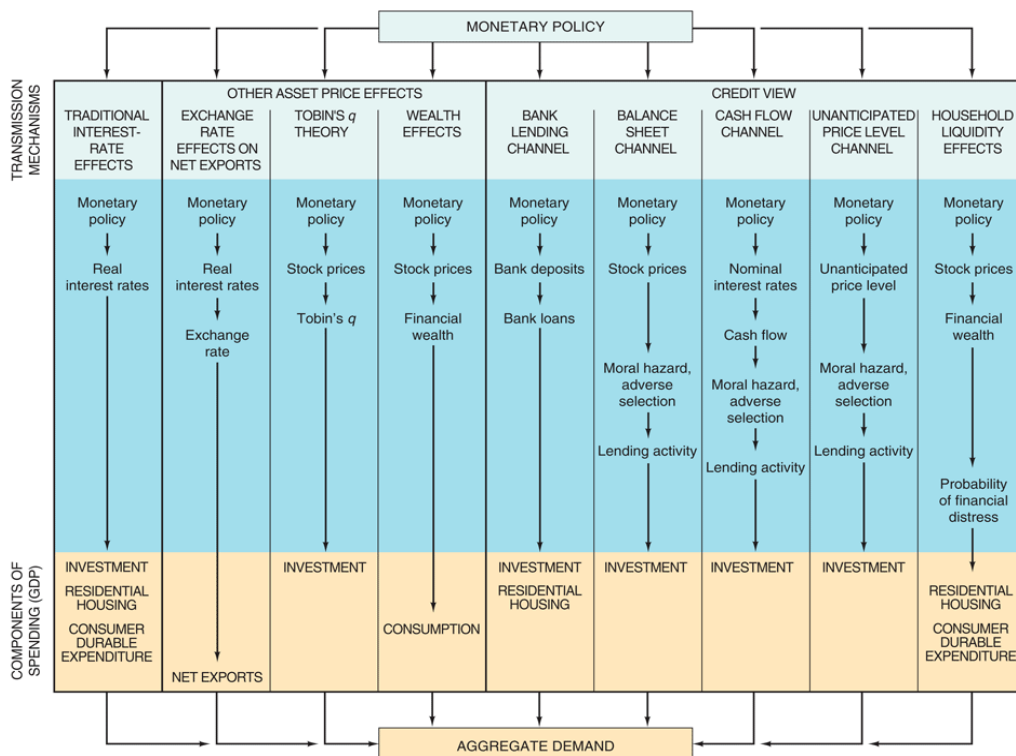

Figure 3.1. The link between Monetary policy and Aggregate demand: Monetary transmission mechanism
Source: (Mishkin, 2013)

APPENDIX 3.B. Stock market liquidity measures and factors impacting stock market liquidity

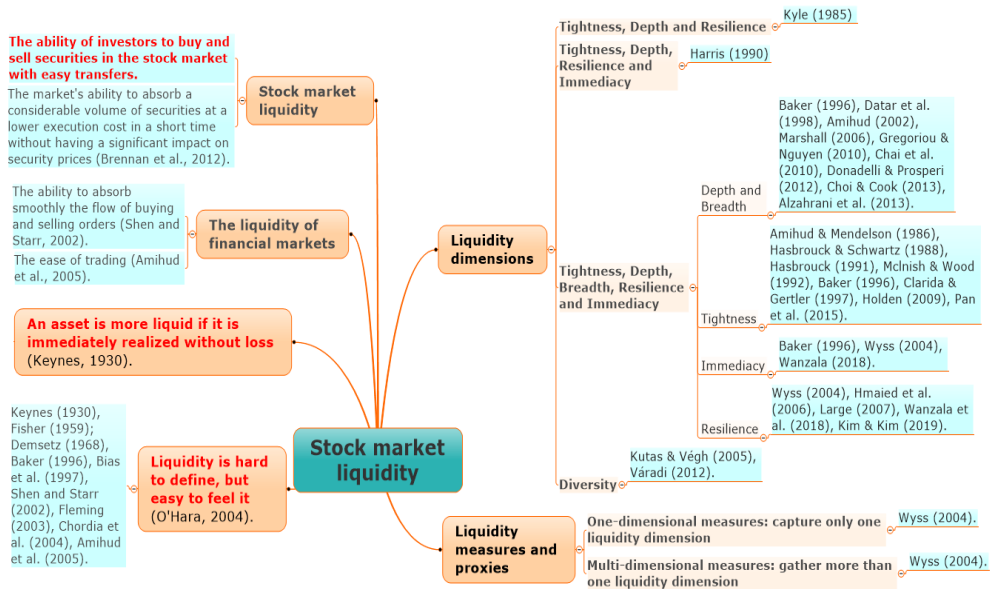

Figure 3.2. Definitions and measures of stock market liquidity

Source: Summarised by the author.

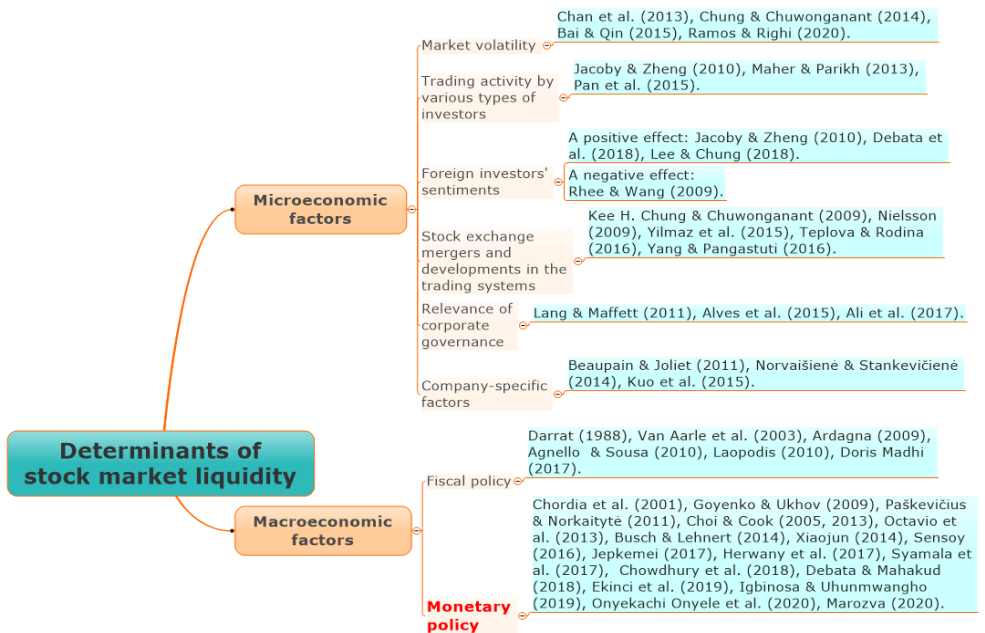

Figure 3.3. Factors impacting stock market liquidity

Source: Summarised by the author.

APPENDIX 3.C. Emerging market economies



Figure 3.4. Real GDP growth of emerging market and developing economies (2000, 2018 and 2021)

Source: https://www.imf.org/external/datamapper/NGDP_RPCH@WEO/OEMDC/ADV_EC/WEOWORLD

APPENDIX 3.D. The relationship of monetary policy and stock market liquidity in EMEs



Figure 3.5. The relationship between monetary policy and stock market

Source: Summarised by the author.

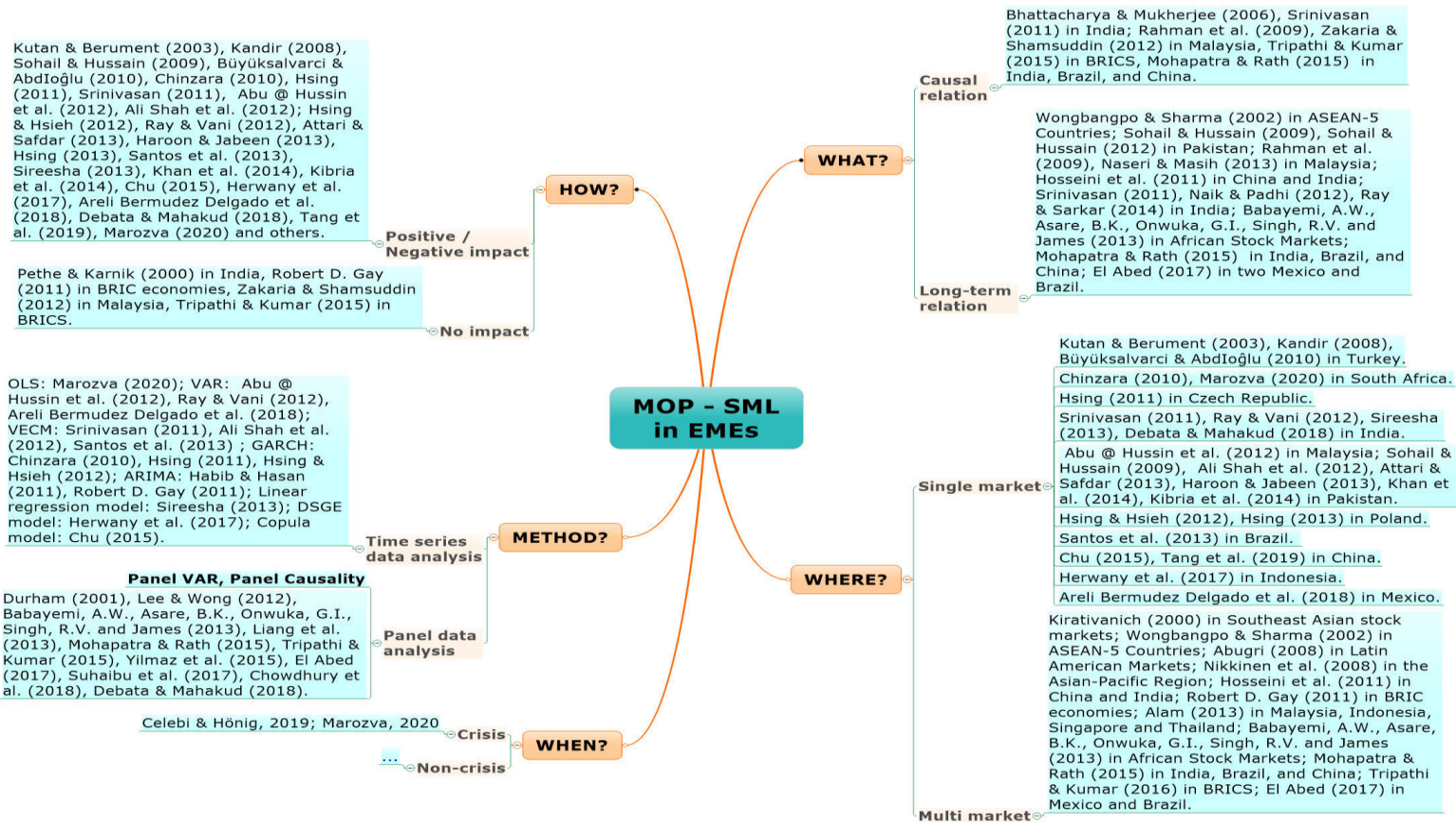

Figure 3.6. The relationship between monetary policy and stock market liquidity in EMEs

Source: Summarised by the author.

CHAPTER 4: APPENDICES

APPENDIX 4.A. Monetary policy and stock market liquidity in EMEs and hypotheses

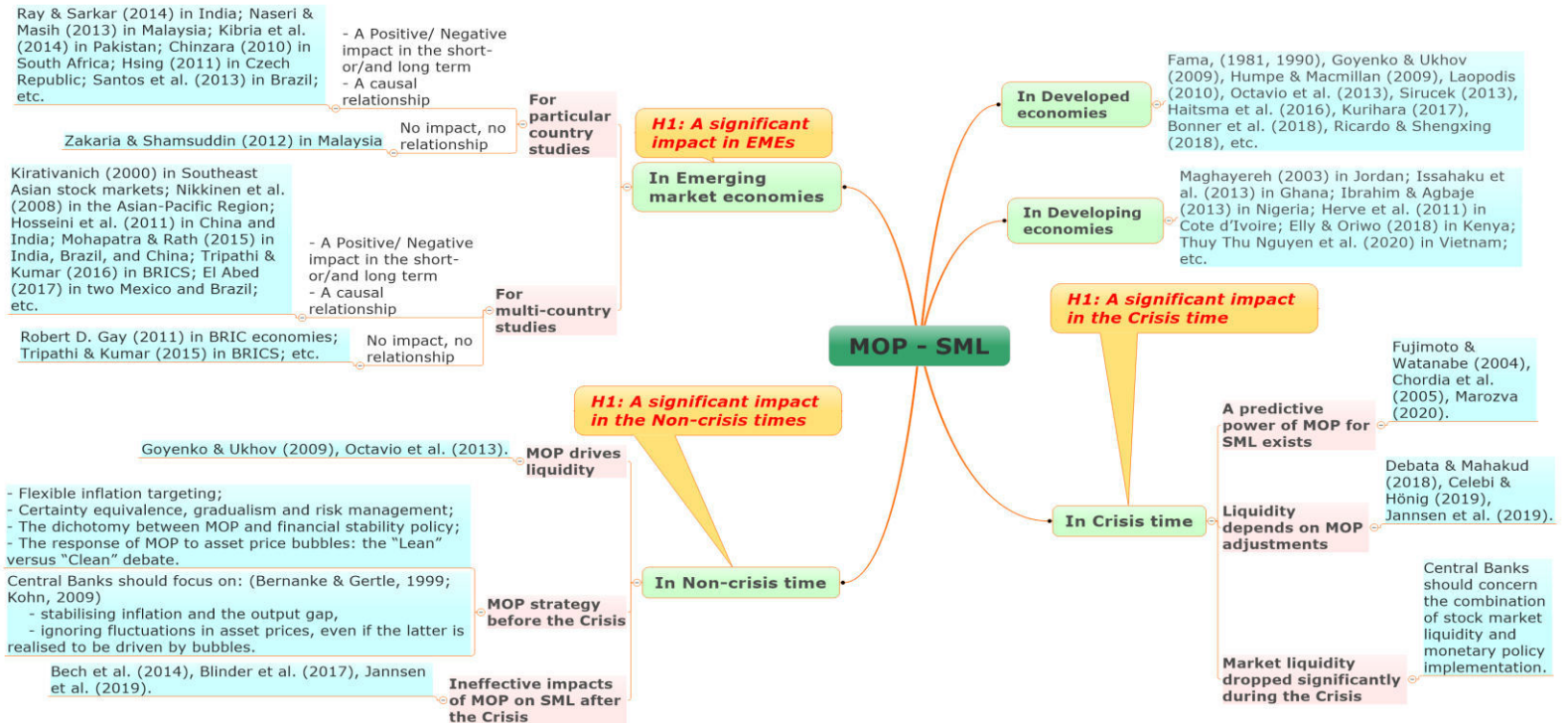

Figure 4.1. Empirical impact of monetary policy on stock market liquidity in EMEs and hypotheses (H1)

Source: Summarised by the author.

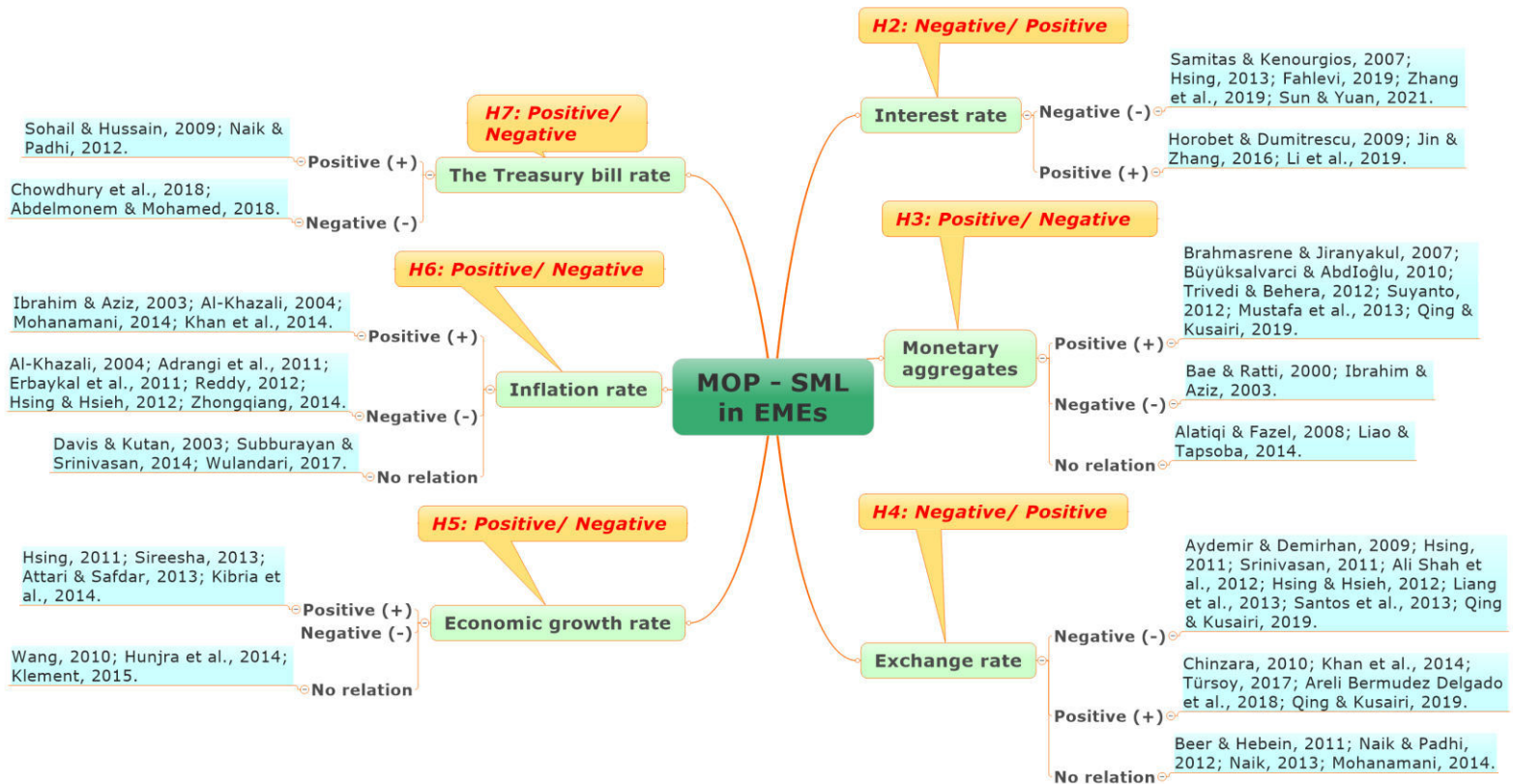

Figure 4.2. Empirical impact of each variable of monetary policy on stock market liquidity in EMEs and hypotheses (from H2 to H7)
 Source: Summarised by the author.

APPENDIX 4.B. Panel unit root tests

Table 4.1. Summary of asymptotic behavior required T and N for the derivation of the limiting distribution of the tests

	The asymptotics used in the derivation of the test statistics
Levin et al. (2002)	$N \rightarrow \infty$ following $T \rightarrow \infty$, $N/T \rightarrow 0$
Harris & Tzavalis (1999)	$N \rightarrow \infty$ and T fix
Breitung (2000)	$N \rightarrow \infty$ following $T \rightarrow \infty$
Im et al. (1997, 2003)	White noise: $N \rightarrow \infty$ and T fix Serial correlation: $N \rightarrow \infty$ following $T \rightarrow \infty$, $N/T \rightarrow k > 0$

Source: Summarised by the author.

APPENDIX 4.C. Descriptive statistics

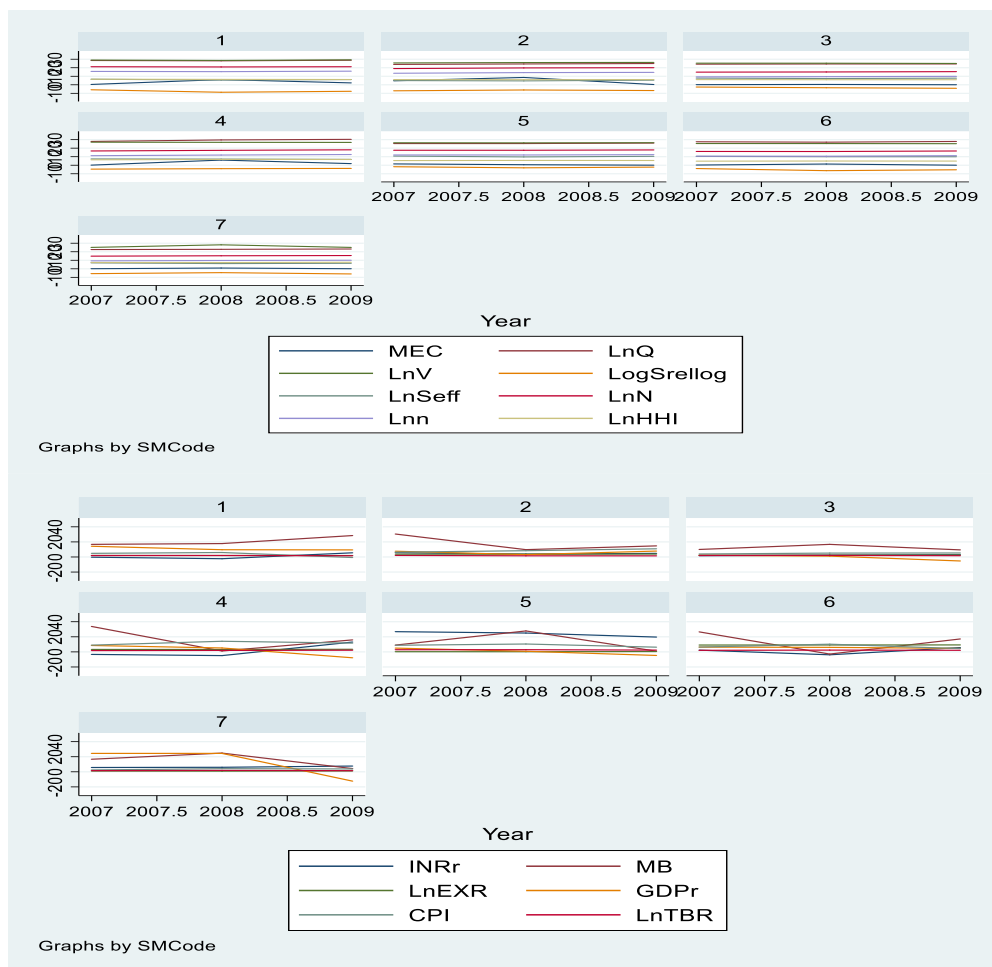
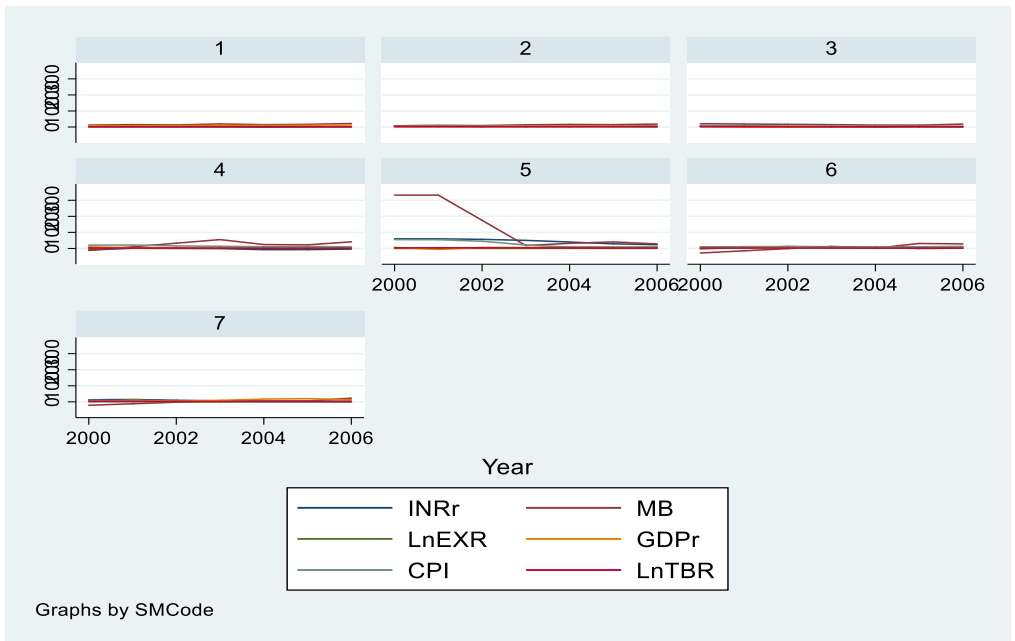
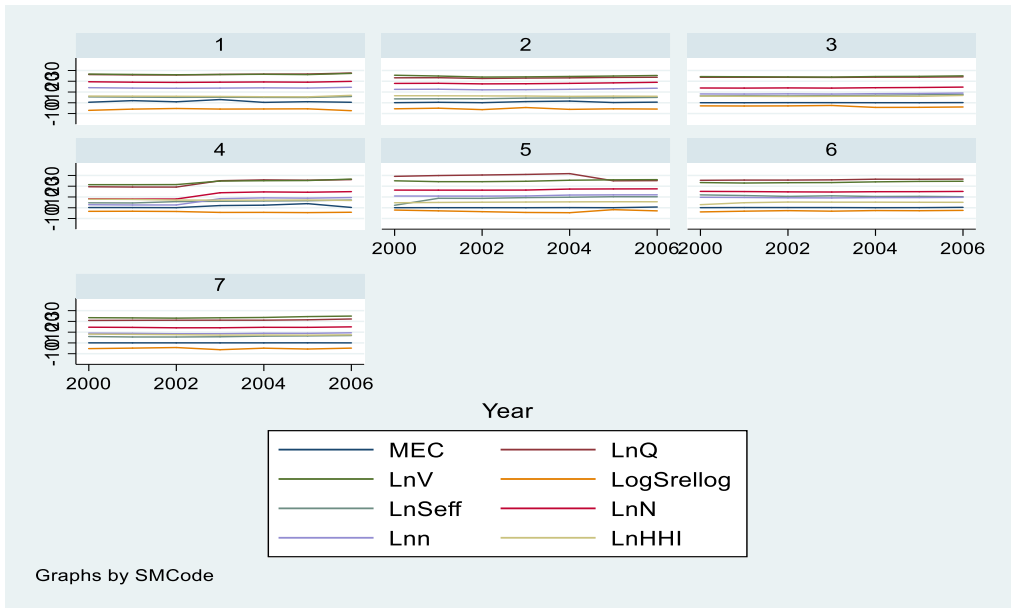

Figure 4.3. Trend of MOP and SML in EMEs during the Crisis time (2007-2009)

Source: Estimated by the author and data processed with Stata 15.



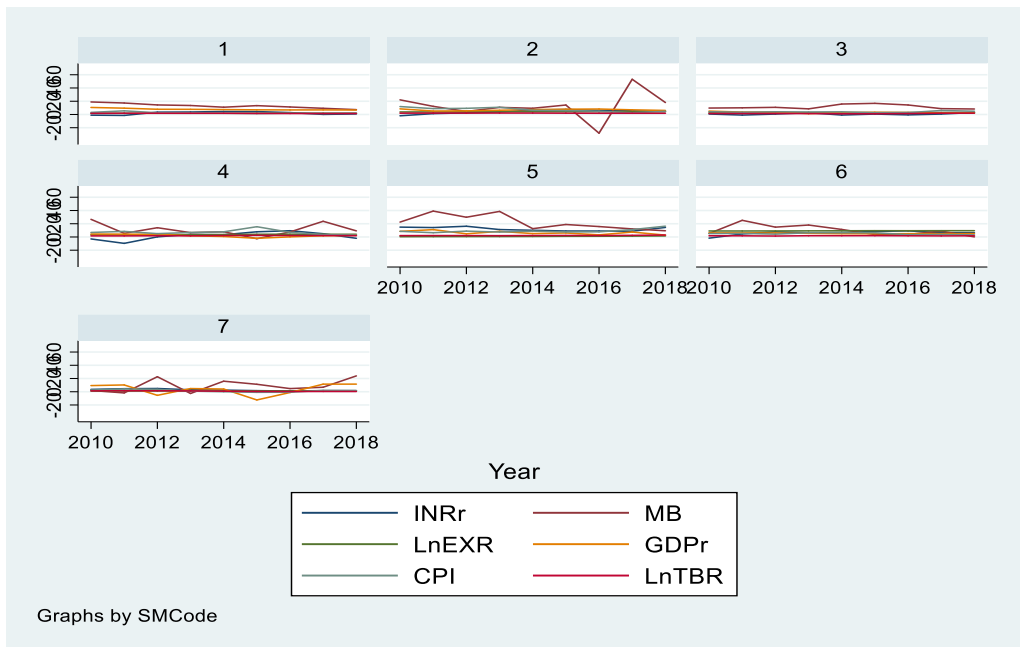
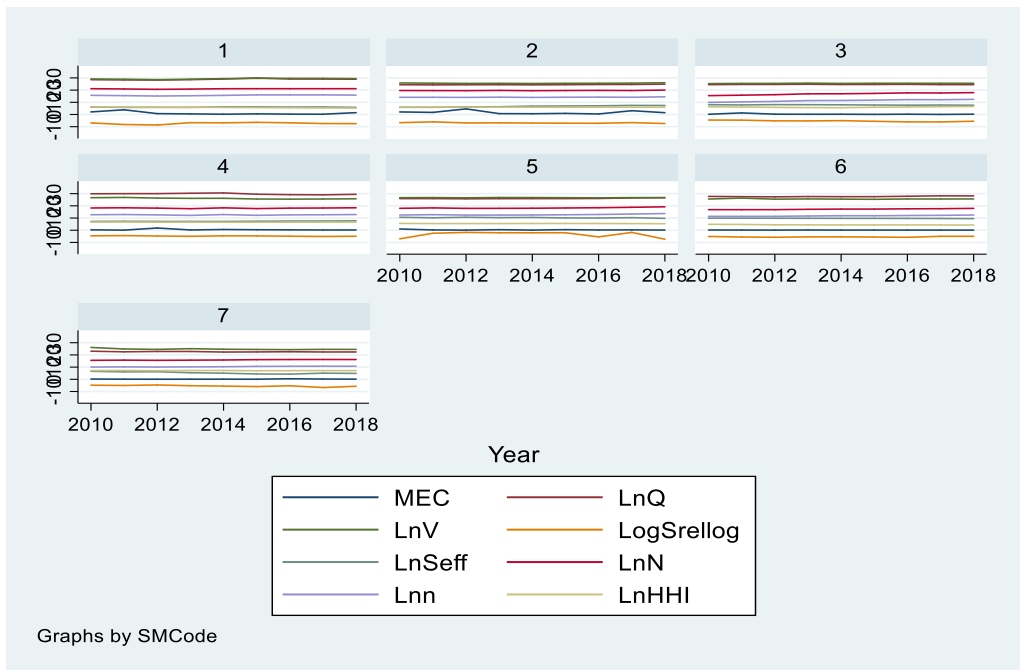

Figure 4.4. Trend of MOP and SML in EMEs during the Non-crisis time (2000-2006 and 2010-2018)

Source: Estimated by the author and data processed with Stata 15.

Table 4.2. Descriptive statistics for all variables in seven selected stock markets, 2000 - 2018 (133 stock market-year observations)

	Mean	Median	Maximum	Minimum	Standard Deviation	Skewness	Kurtosis	Obs
MEC	0.7555	0.2278	8.6193	0.0418	1.3182	3.3060	15.6437	133
LnQ	25.6750	25.5643	31.7050	19.2108	2.6990	0.0103	2.4811	133
LnV	25.6547	25.5802	29.6476	21.4353	1.5928	0.3673	3.9867	133
LogSrellog	-4.9772	-5.0310	-1.7492	-8.7322	1.6022	0.1462	2.4634	133
LnSeff	7.3118	7.0368	11.9603	2.3026	2.0594	0.2572	2.1851	133
LnN	17.1458	17.5342	21.1868	8.1001	2.4758	-0.8609	5.0301	133
Lnn	11.6445	12.0127	16.0779	2.5747	2.5030	-0.8033	4.9619	133
LnHHI	6.0710	6.0474	8.1548	2.8708	0.9057	-0.2470	3.3687	133
INRr	6.3727	3.7718	60.0000	-9.6331	11.2928	2.9991	13.6085	133
MB	19.7315	13.7629	332.2406	-28.2057	43.1136	6.1078	43.4861	133
LnEXR	3.2887	2.5196	9.5022	0.2034	2.6846	1.3299	3.7267	133
GDPPr	5.7006	5.5600	24.4000	-12.3700	5.1781	-0.0575	6.8428	133
CPI	7.0932	5.1300	54.9200	-0.8700	8.0491	4.0093	22.7108	133
LnTBR	1.9573	1.8874	4.0860	0.4055	0.5889	0.6429	5.6889	133
LnMAC	27.4939	26.9608	32.1289	23.8725	2.0177	0.6087	2.8094	133
FIG	0.3159	0.3253	0.9625	-0.0934	0.2252	0.2296	2.2157	133

Source: Estimated by the author and data processed with Stata 15.

APPENDIX 4.D. Classic regression diagnostic tests

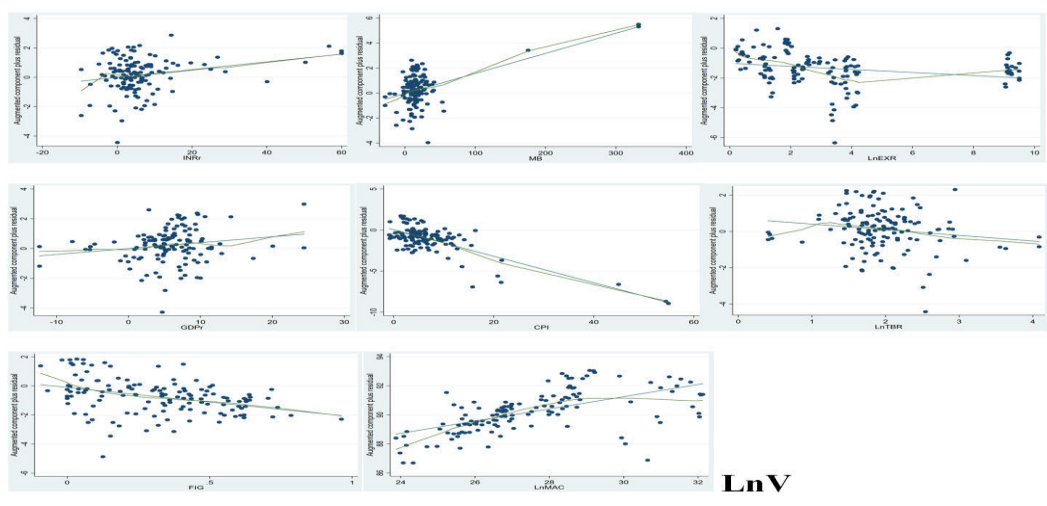
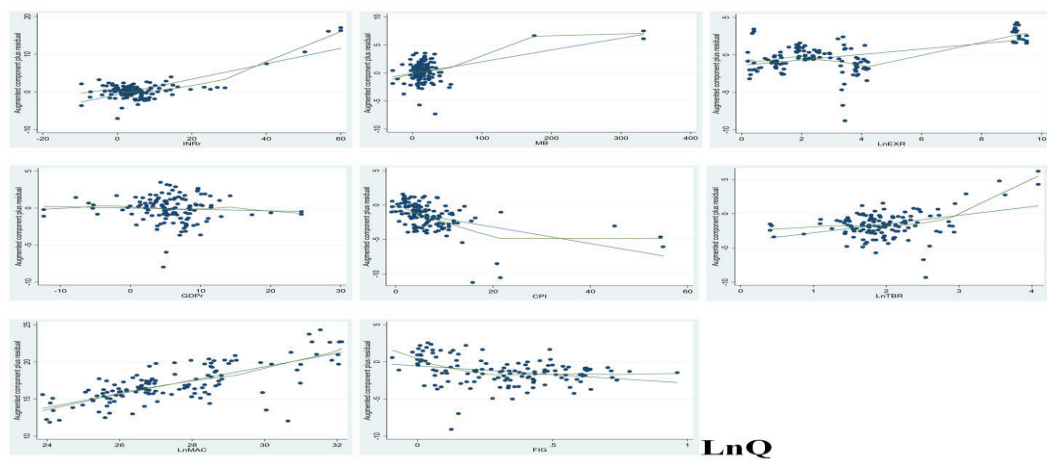
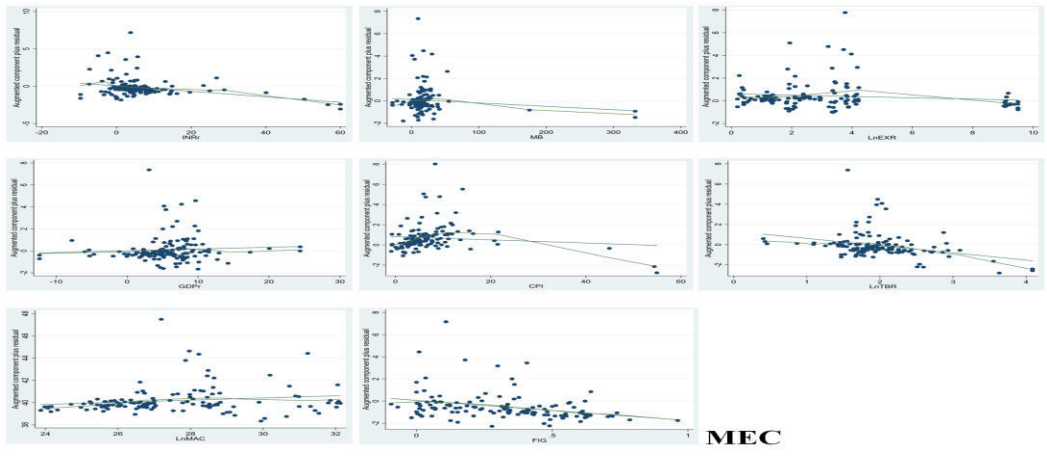

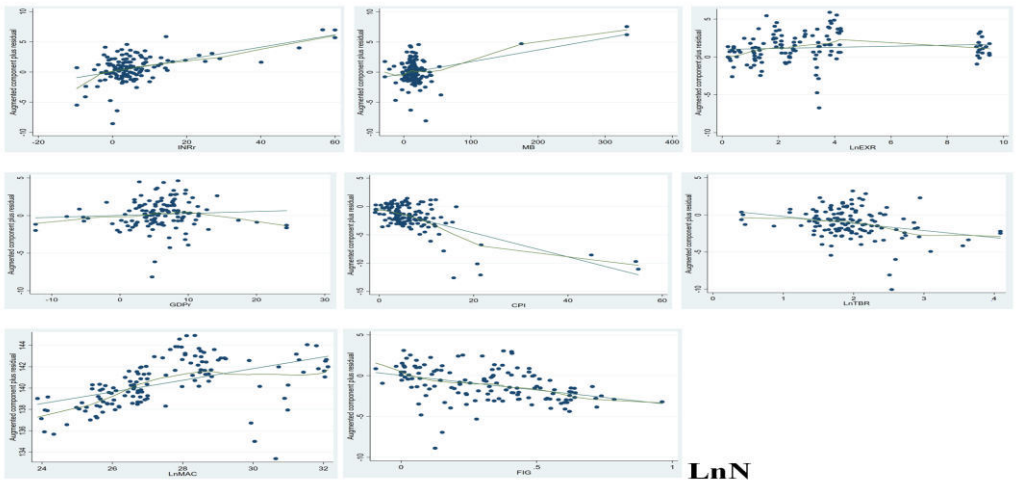
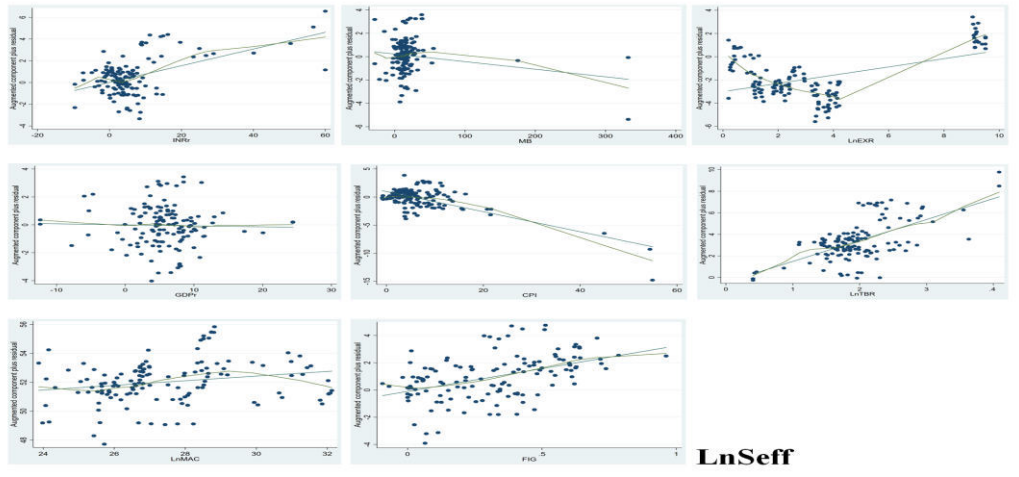
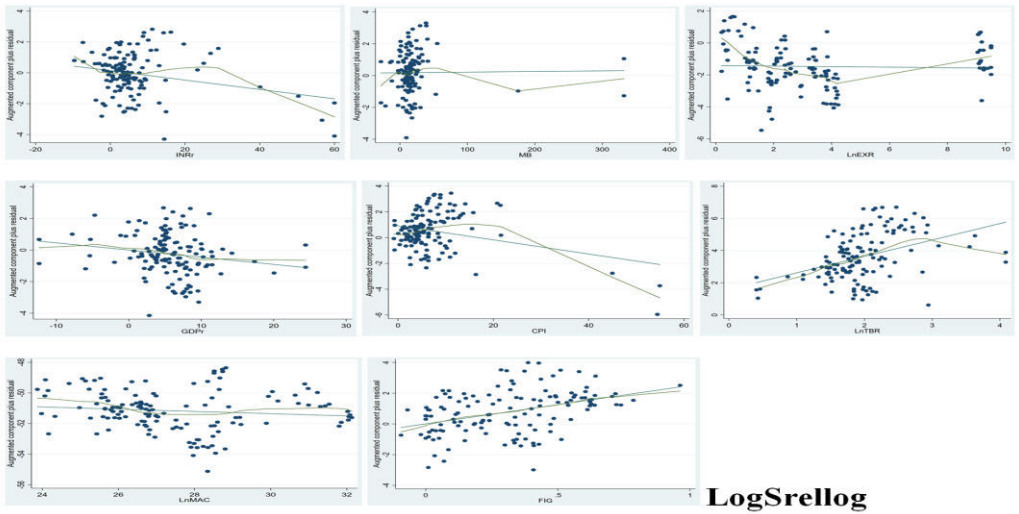

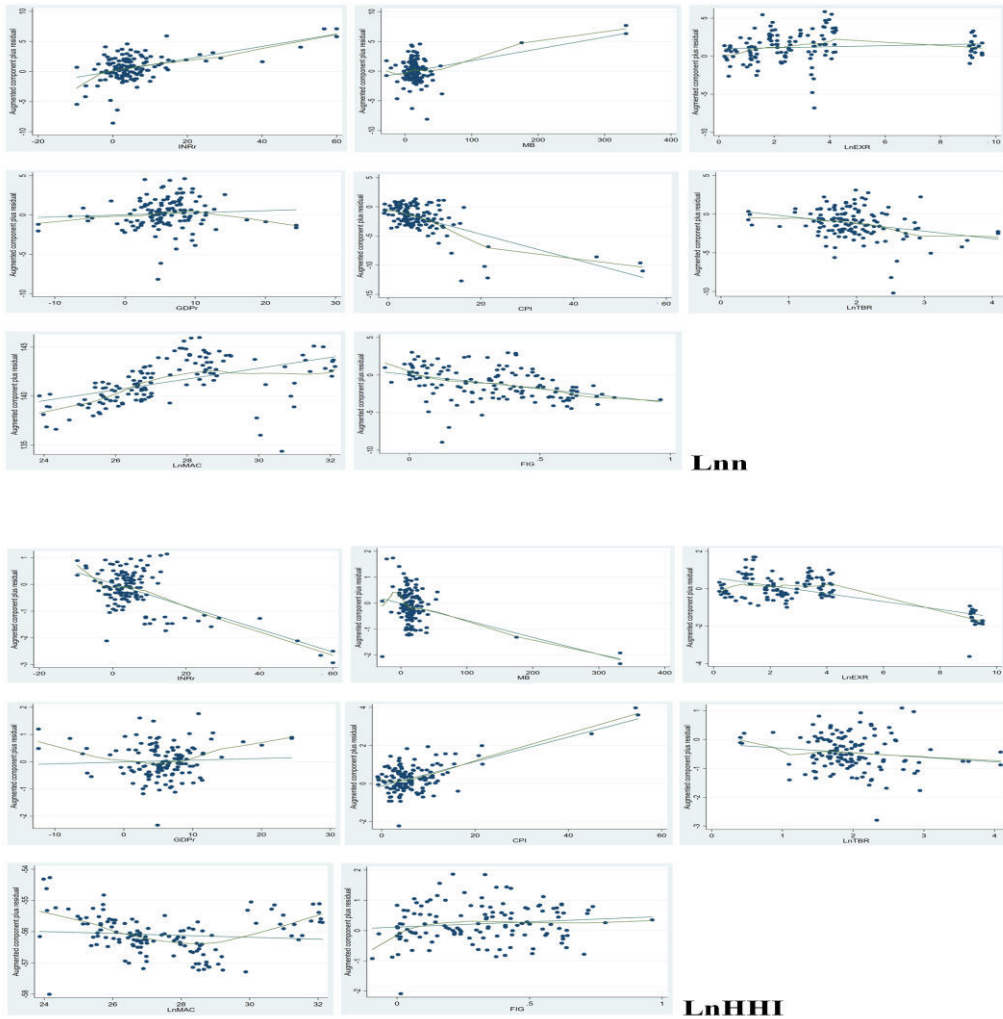
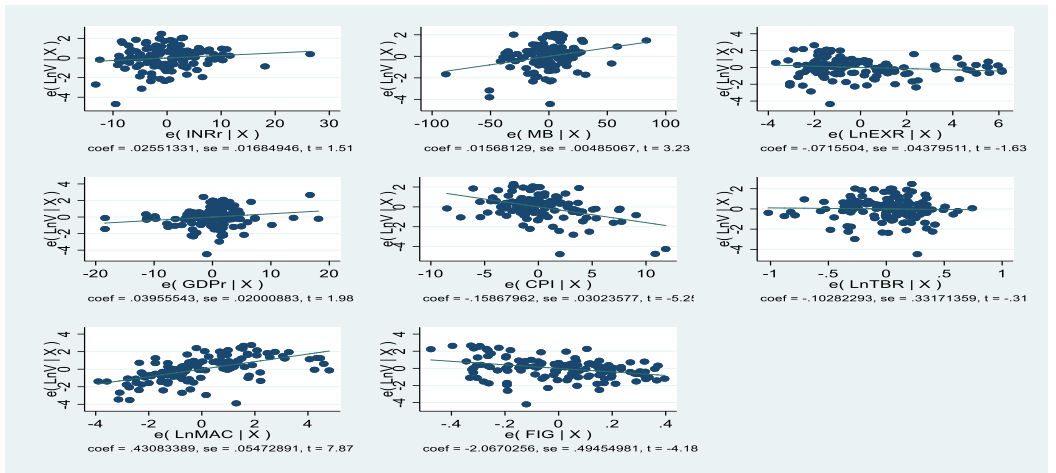
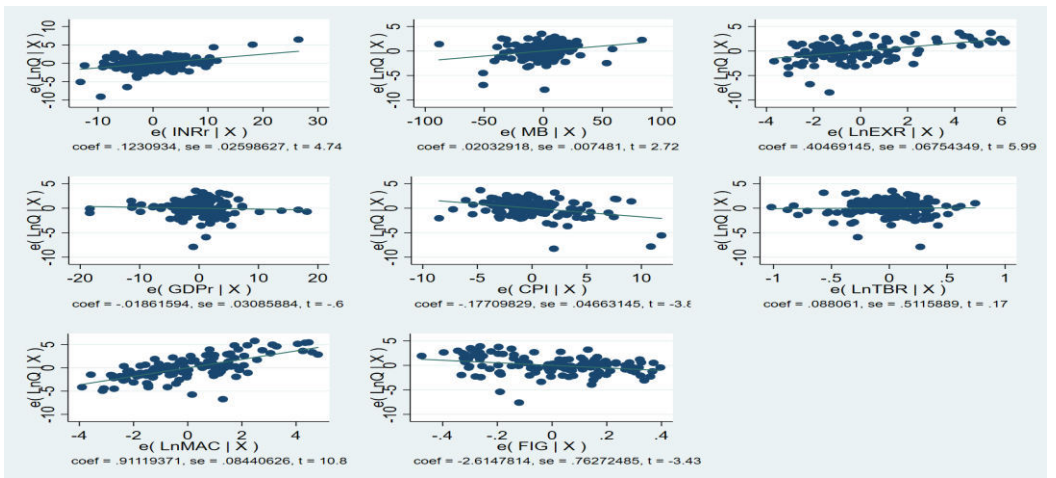
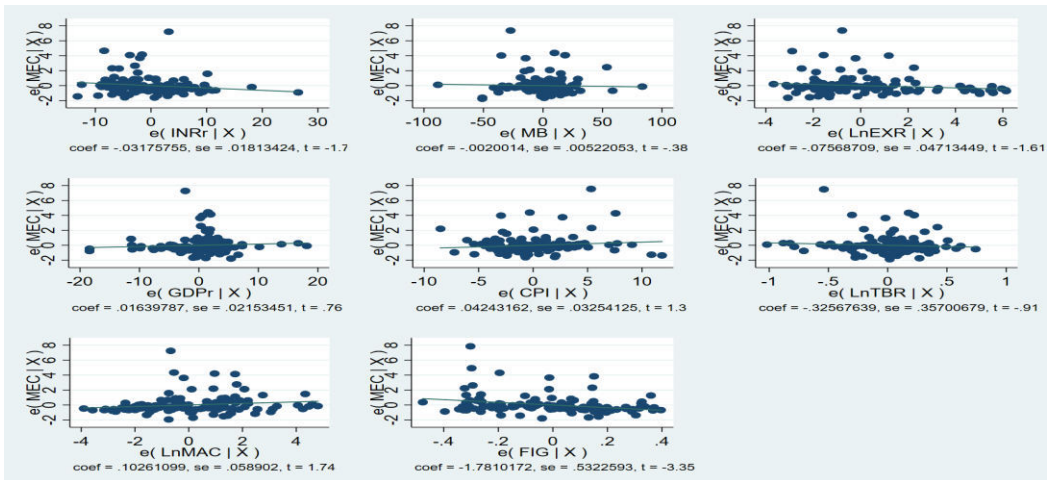
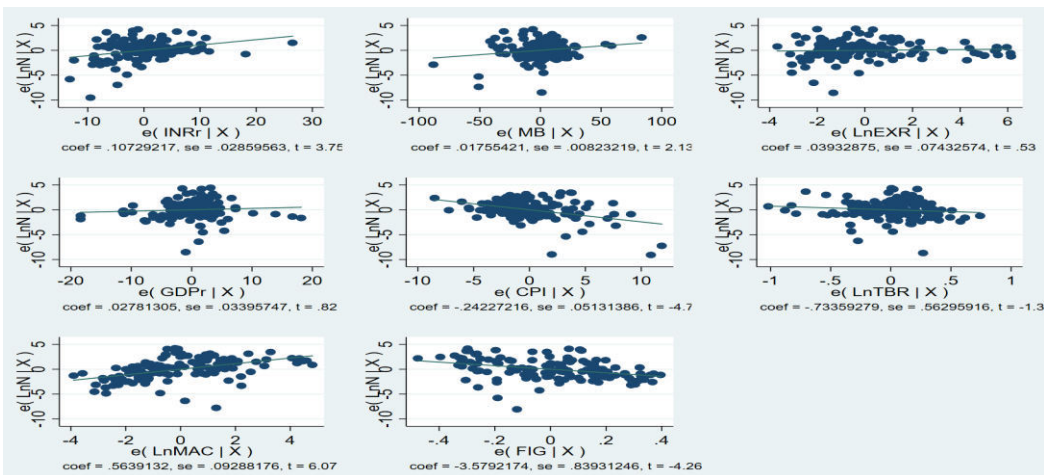
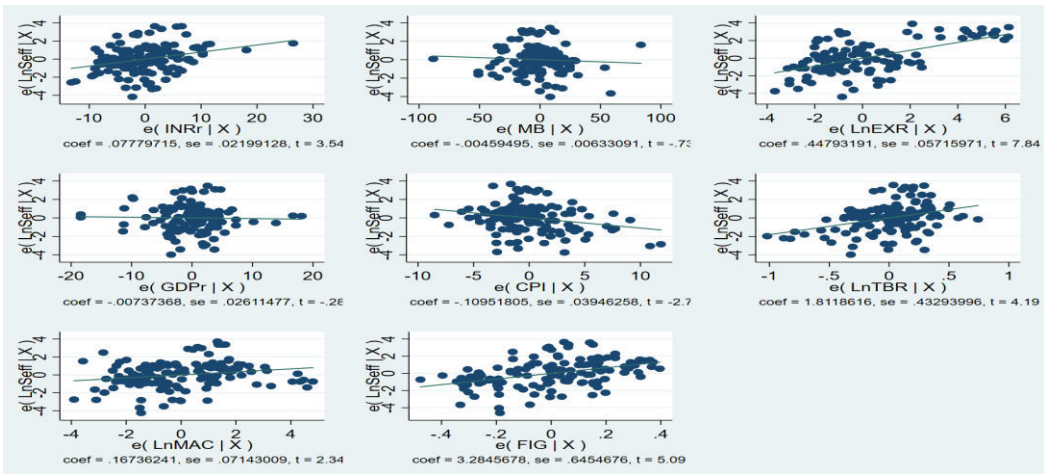
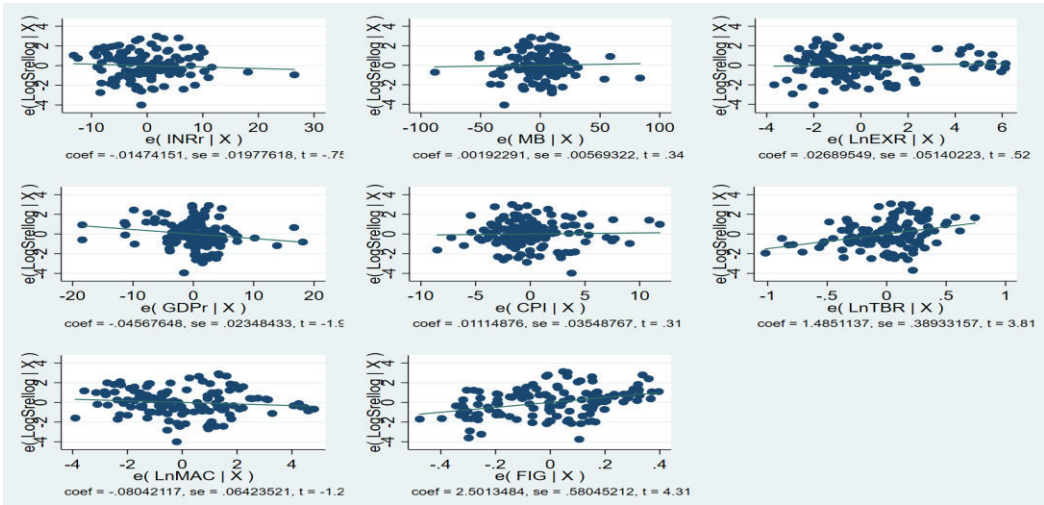

Figure 4.5. An augmented component-plus-residual plot of MEC, LnQ, LnV, LogSrellog, LnSeff, LnN, Lnn and LnHHI

Source: Estimated by the author and data processed with Stata 15.





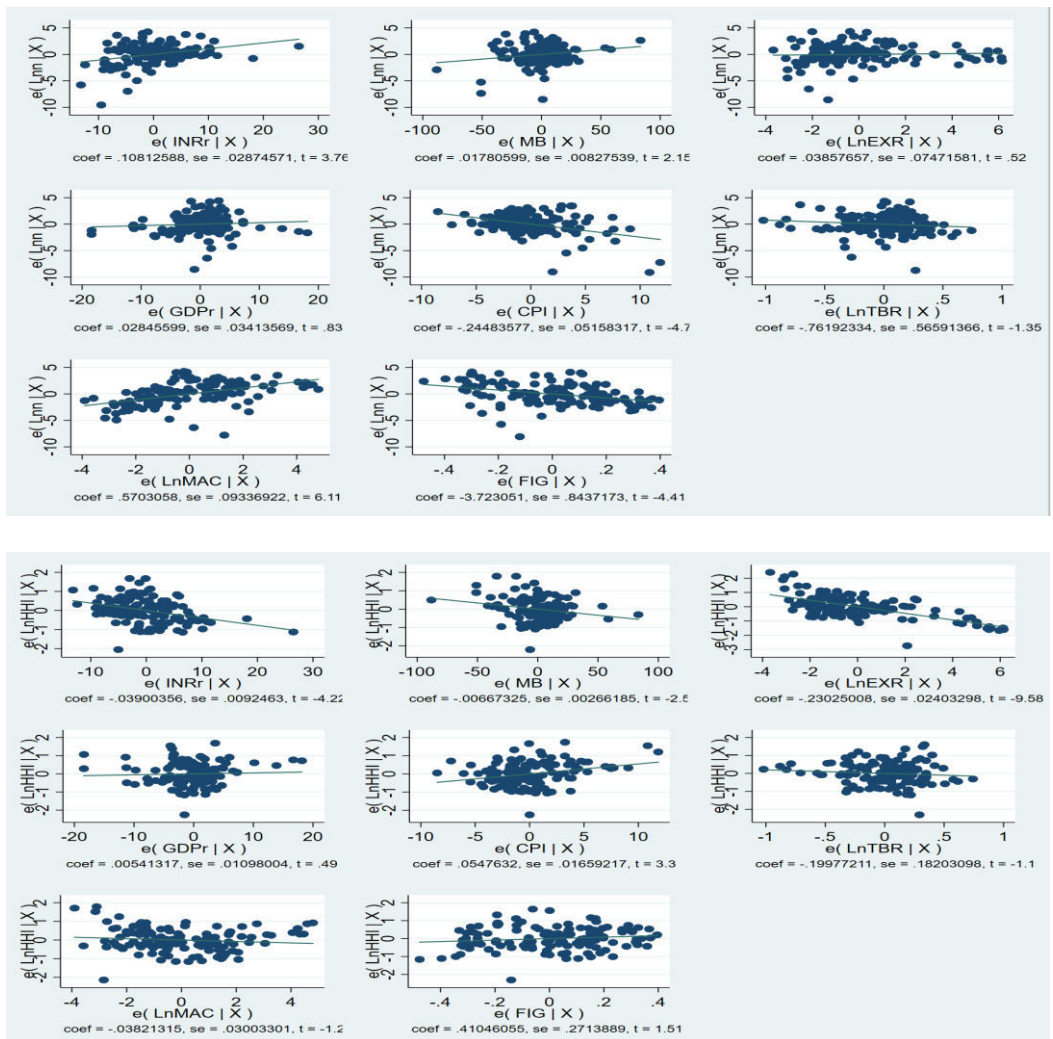

Figure 4.6. An added-variable plot MEC, LnQ, LnV, LogSrellog, LnSeff, LnN, Lnn and LnHHI

Source: Estimated by the author and data processed with Stata 15.

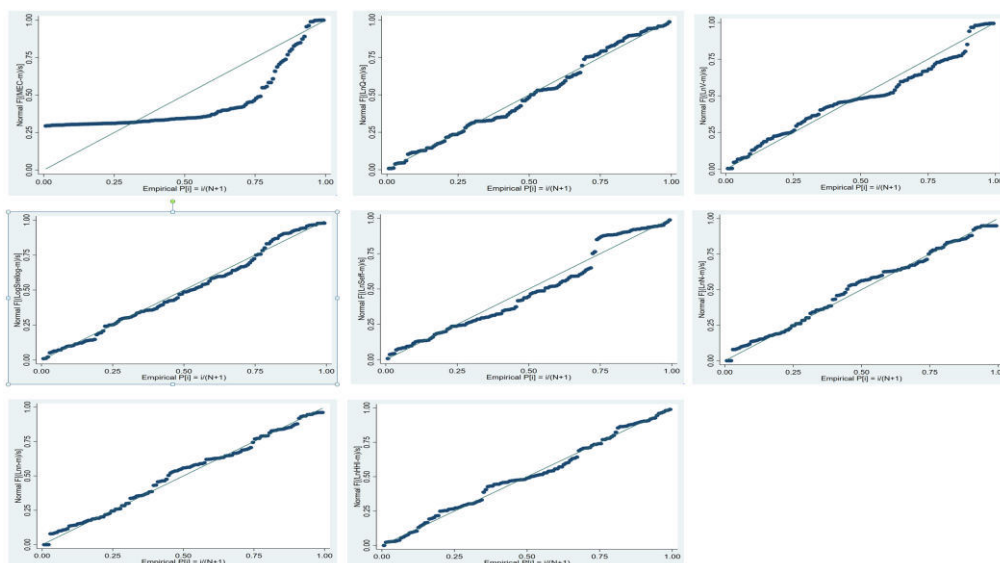

Figure 4.7. A standardized normal probability (P-P) plot of stock market liquidity measures (MEC, LnQ, LnV, LogSrellog, LnSeff, LnN, LnHHI)
 Source: Estimated by the author and data processed with Stata 15.

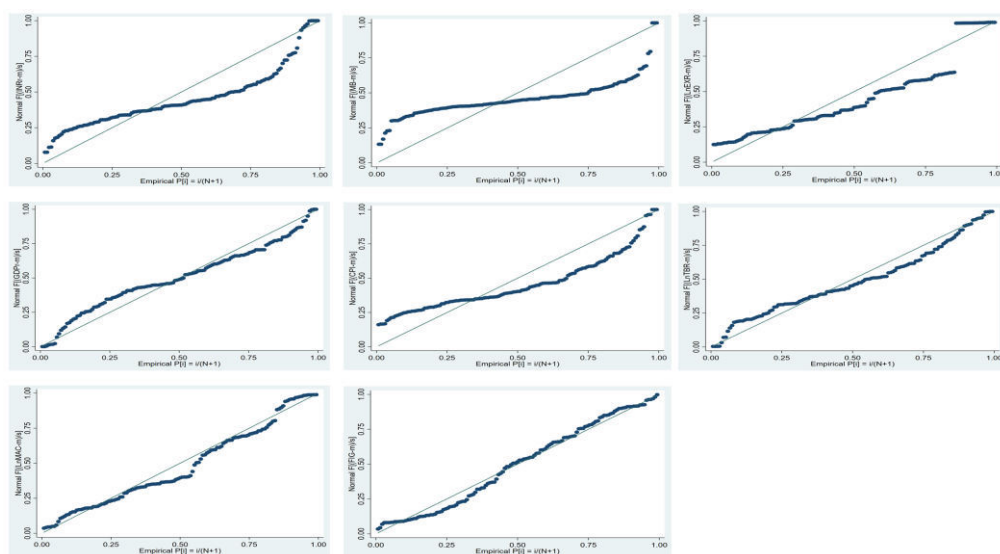

Figure 4.8. A standardized normal probability (P-P) plot of monetary policy measures and control variables (INRr, MB, LnEXR, GDP, CPI, LnTBR, LnMAC, FIG)
 Source: Estimated by the author and data processed with Stata 15.

Table 4.3. Pairwise correlation for SML variables, MOP variables and control variables in seven selected stock markets, 2000-2018

Variables	MEC	LnQ	LnV	LogSrellog	LnSeff	LnN	Lnn	LnHHI
MEC	1.0000							
LnQ	0.1044 0.2318	1.0000						
LnV	0.2618** 0.0023	0.6108** 0.0000	1.0000					
LogSrellog	-0.3075** 0.0003	-0.0743 0.3953	-0.4149** 0.0000	1.0000				
LnSeff	-0.2426** 0.0049	0.3493** 0.0000	0.0140 0.8731	0.4311** 0.0000	1.0000			
LnN	0.3142** 0.0002	0.5610** 0.0000	0.8127** 0.0000	-0.5582* 0.0000	-0.0476 0.5865	1.0000		
Lnn	0.3117** 0.0003	0.5642** 0.0000	0.8183** 0.0000	-0.5610** 0.0000	-0.0496 0.5709	0.9997** 0.0000	1.0000	
LnHHI	0.0792 0.3649	-0.5072** 0.0000	-0.1857** 0.0324	-0.1210 0.1655	-0.6279** 0.0000	-0.2970** 0.0005	-0.2994** 0.0005	1.0000
INRr	-0.1851** 0.0329	0.2472** 0.0041	-0.0968 0.2676	0.3191** 0.0002	0.2156** 0.0127	0.0214 0.8066	0.0189 0.8290	-0.2872** 0.0008
MB	-0.0339 0.6988	0.2501** 0.0037	-0.0250 0.7748	0.2283** 0.0082	-0.0651 0.4566	-0.0174 0.8420	-0.0181 0.8362	-0.1919** 0.0269
LnEXR	-0.0349 0.6904	0.1881** 0.0301	-0.2163** 0.0124	-0.0126 0.8860	0.3969** 0.0000	-0.0830 0.3423	-0.0816 0.3503	-0.5360** 0.0000
GDPr	0.0949 0.2771	-0.1094 0.2101	0.1884** 0.0298	-0.2138** 0.0135	-0.1265 0.1467	0.0975 0.2644	0.0994 0.2550	0.0996 0.2540
CPI	-0.0059 0.9460	0.2161** 0.0125	-0.2385** 0.0057	0.3690** 0.0000	0.0863 0.3235	-0.2220** 0.0102	-0.2239** 0.0096	-0.1733** 0.0460
LnTBR	-0.0814 0.3518	0.2443** 0.0046	-0.1921** 0.0268	0.4382** 0.0000	0.3575** 0.0000	-0.1476* 0.0899	-0.1500* 0.0848	-0.2920** 0.0006

LnMAC	0.2322** 0.0072	0.5049** 0.0000	0.4306** 0.0000	-0.0423 0.6286	-0.0177 0.8397	0.2799** 0.0011	0.2802** 0.0011	0.1201 0.1687
FIG	-0.2226** 0.0100	-0.3434** 0.0001	-0.2003** 0.0208	0.1848** 0.0332	0.0760 0.3844	-0.2591** 0.0026	-0.2668** 0.0019	0.3401** 0.0001
Variables	INRr	MB	LnEXR	GDPr	CPI	LnTBR	LnMAC	FIG
INRr	1.0000							
MB	0.6794** 0.0000	1.0000						
LnEXR	-0.2711** 0.0016	-0.2110** 0.0148	1.0000					
GDPr	-0.107 0.2179	-0.0648 0.4589	-0.0827 0.3438	1.0000				
CPI	0.6752** 0.0000	0.8043** 0.0000	-0.0775 0.3754	-0.1448* 0.0964	1.0000			
LnTBR	0.6987** 0.0000	0.4575** 0.0000	-0.0107 0.9025	-0.0809 0.3545	0.7260** 0.0000	1.0000		
LnMAC	-0.0997 0.2535	0.0718 0.4113	-0.1580* 0.0694	-0.0809 0.3544	0.1655* 0.0569	0.0530 0.5448	1.0000	
FIG	-0.1281 0.1417	-0.1150 0.1874	-0.2642** 0.0021	-0.0747 0.3930	-0.1588* 0.0679	-0.3001** 0.0004	0.0053 0.9516	1.0000

Source: Estimated by the author and data processed with Stata 15.

Note: ***, **, * : significance levels of 1%, 5%, and 10%, respectively.

Table 4.4. Variance Inflation Factor (VIF) Test for Multicollinearity

Variable	VIF	1/VIF
CPI	5.96	0.1678
MB	4.40	0.2272
LnTBR	3.84	0.2605
INRr	3.64	0.2745
LnEXR	1.39	0.7189
FIG	1.25	0.8014
LnMAC	1.23	0.8150
GDPPr	1.08	0.9258
Mean VIF	2.85	

Source: Estimated by the author and data processed with Stata 15.

Table 4.5. A model specification link test for each SML variable

		Coef.	P> t	Specification error
MEC	_hat	0.4567	0.401	No misspecification issue
	_hatsq	0.2904	0.287	
LnQ	_hat	1.2398	0.439	No misspecification issue
	_hatsq	-0.0047	0.881	
LnV	_hat	-4.8029	0.107	No misspecification issue
	_hatsq	0.1128	0.052	
LogSrellog	_hat	0.0826	0.917	No misspecification issue
	_hatsq	-0.0960	0.243	
LnSeff	_hat	0.5008	0.561	No misspecification issue
	_hatsq	0.0332	0.560	
LnN	_hat	1.9663	0.248	No misspecification issue
	_hatsq	-0.0281	0.569	
Lnn	_hat	1.3851	0.220	No misspecification issue
	_hatsq	-0.0165	0.731	
HHI	_hat	0.5949	0.631	No misspecification issue
	_hatsq	0.0352	0.743	

Source: Estimated by the author and data processed with Stata 15.

Table 4.6. Regression specification error test (RESET) for omitted variables for each SML variable

	F(3, 121)	Prob > F	Specification error
MEC	1.25	0.2940	Model has no omitted variables
LnQ	0.53	0.6604	Model has no omitted variables
LnV	1.95	0.1248	Model has no omitted variables
LogSrellog	1.65	0.1812	Model has no omitted variables
LnSeff	0.15	0.9296	Model has no omitted variables
LnN	1.43	0.2374	Model has no omitted variables
Lnn	1.46	0.2281	Model has no omitted variables
LnHHI	1.77	0.1570	Model has no omitted variables

Source: Estimated by the author and data processed with Stata 15.

APPENDIX 4.E. Preliminary tests concerning panel regression diagnostics

Table 4.7: Cross sectional dependency test for each SML variable (Breusch-Pagan LM test)

Variables	chi2 (21)	Pr	
MEC	84.791	0.0000	Cross-sectional correlation
LnQ	48.930	0.0005	Cross-sectional correlation
LnV	58.360	0.0000	Cross-sectional correlation
LogSrellog	33.866	0.0375	Cross-sectional correlation
LnSeff	63.178	0.0000	Cross-sectional correlation
LnN	62.663	0.0000	Cross-sectional correlation
Lnn	65.137	0.0000	Cross-sectional correlation
LnHHI	61.249	0.0000	Cross-sectional correlation

Source: Estimated by the author and data processed with Stata 15.

Table 4.8: Panel Unit Roots test for each variable

Panel unit root test	Variables	For constant and no trend (1)		For constant and trend (2)		For no trend, cross-sectional means removed (3)		For cross-sectional dependence (4)		Stationary state			
		Statistic	Prob.	Statistic	Prob.	Statistic	Prob.	Statistic	Prob.	(1)	(2)	(3)	(4)
<i>Breitung t-stat</i>													
	MEC	-6.2568	0.0000	-5.9698	0.0000	-5.8712	0.0000	-3.3328	0.0004	Yes	Yes	Yes	Yes
	LnQ	0.7314	0.7677	-0.3391	0.3673	-0.8483	0.1981	0.1900	0.5753	No	No	No	No
	LnV	0.0708	0.5282	-1.0830	0.1394	-1.1862	0.1178	-0.3019	0.3814	No	No	No	No
	LogSrellog	-2.0408	0.0206	-4.0602	0.0000	-4.8846	0.0000	-3.4822	0.0002	Yes	Yes	Yes	Yes

	LnSeff	1.5551	0.9400	-0.1782	0.4293	1.0947	0.8632	0.2554	0.6008	No	No	No	No
	LnN	3.2020	0.9993	-1.2239	0.1105	0.3316	0.6299	0.8425	0.8003	No	No	No	No
	Lnn	3.2320	0.9994	-1.1642	0.1222	0.2454	0.5969	0.8377	0.7989	No	No	No	No
	LnHHI	-0.0580	0.4769	0.5598	0.7122	-0.2726	0.3926	-0.3837	0.3506	No	No	No	No
	INR	-0.0796	0.4683	-0.4269	0.3347	-0.0909	0.4638	0.0185	0.5074	No	No	No	No
	MB	-1.0215	0.1535	-1.3314	0.0915	-0.2304	0.4089	0.2172	0.5860	No	No	No	No
	LnEXR	2.5846	0.9951	1.5802	0.9430	2.6053	0.9954	2.4510	0.9929	No	No	No	No
	GDPPr	-4.0861	0.0000	-3.7912	0.0001	-3.3386	0.0004	-3.3756	0.0004	Yes	Yes	Yes	Yes
	CPI	-0.5594	0.2879	0.1229	0.5489	-0.4741	0.3177	0.0938	0.5374	No	No	No	No
	LnTBR	-0.1255	0.4501	0.4745	0.6824	-0.5558	0.2892	0.0194	0.5077	No	No	No	No
	LnMAC	0.8462	0.8013	-1.5962	0.0552	-0.2565	0.3988	0.5385	0.7049	No	No	No	No
	FIG	-2.9270	0.0017	-1.6946	0.0451	-3.1305	0.0009	-1.4376	0.0753	Yes	Yes	Yes	Yes
Levin, Lin & Chu t* (LLL)													
	MEC	-4.3678	0.0000	-3.7568	0.0001	-5.1043	0.0000	-5.1145	0.0000	Yes	Yes	Yes	Yes
	LnQ	-2.8608	0.0021	-0.6204	0.2675	-1.4617	0.0719	-5.4093	0.0000	Yes	No	No	Yes
	LnV	-4.2594	0.0000	-1.7257	0.0422	2.7442	0.9970	-5.9794	0.0000	Yes	Yes	No	Yes
	LogSrellog	0.0300	0.0479	-1.2523	0.1052	-1.9387	0.0263	-3.0632	0.0011	Yes	No	Yes	Yes
	LnSeff	-3.7332	0.0001	-2.9855	0.0014	0.5865	0.7212	3.9988	1.0000	Yes	Yes	No	No
	LnN	-0.2809	0.3894	-1.7642	0.0388	0.8442	0.8007	-1.7964	0.0362	No	Yes	No	Yes
	Lnn	-0.2539	0.3998	-1.8020	0.0358	1.8352	0.9668	-1.5707	0.0581	No	Yes	No	No
	LnHHI	-2.5581	0.0053	-1.4521	0.0732	2.2631	0.9882	5.3078	1.0000	Yes	No	No	No
	INR	-4.2704	0.0000	-2.6617	0.0039	-0.3311	0.3703	-1.1012	0.1354	Yes	Yes	No	No
	MB	-8.6142	0.0000	-7.4821	0.0000	2.0531	0.9800	-1.6179	0.0528	Yes	Yes	No	No
	LnEXR	1.9973	0.9771	-0.7069	0.2398	3.5500	0.9998	3.2410	0.9994	No	No	No	No
	GDPPr	-3.3644	0.0004	-3.0936	0.0010	-0.1343	0.4466	1.3599	0.9131	Yes	Yes	No	No
	CPI	-4.9073	0.0000	-3.8223	0.0001	6.1060	1.0000	-3.8127	0.0001	Yes	Yes	No	Yes
	LnTBR	-3.3443	0.0004	-1.9178	0.0276	1.4552	0.9272	1.9911	0.9768	Yes	Yes	No	No
	LnMAC	-4.1607	0.0000	-1.4202	0.0778	0.2672	0.6053	-2.8989	0.0019	Yes	No	No	Yes
	FIG	-3.3723	0.0004	-2.7428	0.0030	-1.7382	0.0411	0.2841	0.2841	Yes	Yes	Yes	No

Harris and Tzavalis (HT)													
	MEC	0.1151	0.0000	0.0902	0.0000	0.0962	0.0000	0.1151	0.0000	Yes	Yes	Yes	Yes
	LnQ	0.8051	0.2217	0.7163	0.8114	0.8028	0.2103	0.8051	0.2738	No	No	No	No
	LnV	0.7874	0.1427	0.6803	0.6736	0.5421	0.0000	0.7874	0.1872	No	No	Yes	No
	LogSrellog	0.3385	0.0000	-0.0613	0.0000	0.0951	0.0000	0.3385	0.0000	Yes	Yes	Yes	Yes
	LnSeff	0.5487	0.0000	0.3085	0.0000	0.5239	0.0000	0.5487	0.0000	Yes	Yes	Yes	Yes
	LnN	0.8677	0.6188	0.7313	0.8561	0.7616	0.0659	0.8677	0.6612	No	No	No	No
	Lnn	0.8683	0.6227	0.7289	0.8495	0.7589	0.0600	0.8683	0.6647	No	No	No	No
	LnHHI	0.5068	0.0000	0.3838	0.0009	0.4528	0.0000	0.5068	0.0000	Yes	Yes	Yes	Yes
	INR	0.7673	0.0793	0.5105	0.0559	0.7903	0.1542	0.7673	0.1125	No	No	No	No
	MB	0.6314	0.0001	0.6078	0.3367	0.6249	0.0001	0.6314	0.0003	Yes	No	Yes	Yes
	LnEXR	1.0313	0.9990	0.8376	0.9904	0.9876	0.9905	1.0313	0.9989	No	No	No	No
	GDPPr	0.2060	0.0000	0.0835	0.0000	0.1975	0.0000	0.2060	0.0000	Yes	Yes	Yes	Yes
	CPI	0.7119	0.0092	0.7345	0.8647	0.7088	0.0080	0.7119	0.0173	Yes	No	Yes	Yes
	LnTBR	0.7859	0.1373	0.6453	0.5115	0.7844	0.1317	0.7859	0.1810	No	No	No	No
	LnMAC	0.8653	0.6032	0.5625	0.1672	0.7055	0.0069	0.8653	0.6470	No	No	Yes	No
	FIG	0.5608	0.0000	0.4201	0.0037	0.4958	0.0000	0.5608	0.0000	Yes	Yes	Yes	Yes
Im-Pesaran-Shin (IPS)													
	MEC	-4.9879	0.0000	-5.0852	0.0000	-4.7703	0.0000			Yes	Yes	Yes	
	LnQ	-0.1203	0.4521	-0.2808	0.3894	-2.2868	0.0111			No	No	Yes	
	LnV	0.0697	0.5278	-0.8888	0.1870	-3.0608	0.0011			No	No	Yes	
	LogSrellog	-2.7599	0.0029	-5.0320	0.0000	-4.2421	0.0000			Yes	Yes	Yes	
	LnSeff	-2.0795	0.0188	-3.0567	0.0011	-2.7848	0.0027			Yes	Yes	Yes	
	LnN	2.9573	0.9984	-2.0286	0.0212	-1.0084	0.1566			No	Yes	No	
	Lnn	3.0396	0.9988	-2.1197	0.0170	-1.1164	0.1321			No	Yes	No	
	LnHHI	-3.9786	0.0000	-3.4834	0.0002	-4.2668	0.0000			Yes	Yes	Yes	
	INR	-3.3337	0.0004	-2.4932	0.0063	-1.9557	0.0253			Yes	Yes	Yes	
	MB	-4.2595	0.0000	-4.2871	0.0000	-3.8927	0.0000			Yes	Yes	Yes	
	LnEXR	4.2739	1.0000	1.1293	0.8706	2.4954	0.9937			No	No	No	

	GDP _r	-3.6516	0.0001	-4.2734	0.0000	-4.3319	0.0000			Yes	Yes	Yes	
	CPI	-3.6755	0.0001	-3.2207	0.0006	-2.9321	0.0017			Yes	Yes	Yes	
	LnTBR	-1.2347	0.1085	-1.1203	0.1313	-0.7997	0.2119			No	No	No	
	LnMAC	0.2022	0.5801	-1.3254	0.0925	-0.5105	0.3048			No	No	No	
	FIG	-2.1200	0.0170	-2.5313	0.0057	-2.0659	0.0194			Yes	Yes	Yes	

Source: Estimated by the author and data processed with Stata 15.

Table 4.9: Time-fixed effects tests for each SML variable

Variables	F(17, 96)	Prob > F	
MEC	1.93	0.0243	Time fixed effects are needed
LnQ	5.75	0.0000	Time fixed effects are needed
LnV	11.48	0.0000	Time fixed effects are needed
LogSrellog	1.92	0.0248	Time fixed effects are needed
LnSeff	3.02	0.0003	Time fixed effects are needed
LnN	6.96	0.0000	Time fixed effects are needed
Lnn	6.96	0.0000	Time fixed effects are needed
LnHHI	1.14	0.3332	No time fixed effects are needed

Source: Estimated by the author and data processed with Stata 15.

Table 4.10: Heteroskedasticity of Wald test

Variables	chi2 (7)	Prob>chi2	
MEC	66.58	0.0000	Presence of heteroskedasticity
LnQ	611.24	0.0000	Presence of heteroskedasticity
LnV	306.14	0.0000	Presence of heteroskedasticity
LogSrellog	36.51	0.0000	Presence of heteroskedasticity
LnSeff	35.03	0.0000	Presence of heteroskedasticity
LnN	222.26	0.0000	Presence of heteroskedasticity
Lnn	182.03	0.0000	Presence of heteroskedasticity
LnHHI	80.65	0.0000	Presence of heteroskedasticity

Source: Estimated by the author and data processed with Stata 15.

Table 4.11: Serial correlation of Wooldridge test

Variables	F(1, 6)	Prob > F	
MEC	10.725	0.0169	Serial correlation
LnQ	13.281	0.0108	Serial correlation
LnV	7.744	0.0319	Serial correlation
LogSrellog	1.177	0.3196	No serial correlation
LnSeff	160.384	0.0000	Serial correlation
LnN	489.019	0.0000	Serial correlation
Lnn	468.683	0.0000	Serial correlation
LnHHI	12.270	0.0128	Serial correlation

Source: Estimated by the author and data processed with Stata 15.

Table 4.12: Endogeneity tests with control variables

Variables	F(8, 124)	Prob > F	
MEC	3.37	0.0016	No endogeneity
LnQ	23.02	0.0000	No endogeneity
LnV	16.41	0.0000	No endogeneity
LogSrellog	7.94	0.0000	No endogeneity
LnSeff	15.82	0.0000	No endogeneity
LnN	11.27	0.0000	No endogeneity
Lnn	11.57	0.0000	No endogeneity
LnHHI	18.76	0.0000	No endogeneity

Source: Estimated by the author and data processed with Stata 15.

APPENDIX 4.F. Fixed Effects Model regression

Table 4.13: Panel Fixed Effects using interaction with FCT (With control variables)

	DV=MEC	DV=LnQ	DV= LnV	DV=LogSrellog	DV= LnSeff	DV=LnN	DV=Lnn	DV=LnHHI
INRr	-0.0170	0.1771***	0.0053	-0.0604***	-0.0356**	0.0878***	0.0871***	-0.0091
MB	-0.0008	0.0106*	0.0086***	0.0111**	0.0017	0.0138***	0.0135***	-0.0036**
LnEXR	0.6046	-1.0085	-1.1739***	-1.3556**	-0.6185	1.4817**	1.3101*	0.4017*
GDPPr	-0.0173	-0.0567	0.0067	-0.0028	0.0203	-0.0361	-0.0367	0.0023
CPI	0.0346	-0.1332***	-0.0884***	-0.0530	-0.0943***	-0.1503***	-0.1492***	0.0169
LnTBR	-0.3088	0.8252	0.5545**	0.7170*	1.9052***	0.2281	0.2469	0.0257
FCT	3.7020*	5.4654**	2.9679**	1.1429	4.8903***	2.7541	2.7995	-0.3458
INRrxFCT	0.0863	-0.1203*	-0.0252	0.0481	-0.0145	-0.0655	-0.0650	0.0018
MBxFCT	-0.0155	-0.0253	0.0055	-0.0194	-0.0171	-0.0055	-0.0043	-0.0011
LnEXRxFCT	0.0936	-0.0166	-0.0525	-0.1361	-0.0152*	-0.1379	-0.1301	0.0147
GDPPrxFCT	-0.0404	0.0846	0.0494*	-0.0221	-0.0011	0.0656	0.0661	0.0027
CPIxFCT	0.0694	0.1850*	0.1215**	0.0468	0.0714	0.2624***	0.2575***	-0.0392
LnTBRxFCT	-2.7161**	-0.7408	-0.5674	-0.6800	-0.8541	-0.2051	-0.2289	0.2798
LnMAC	0.3110	-0.8523*	-0.0843	-0.3078	-0.3325	-0.6206**	-0.5931*	0.0770
FIG	0.5540	-0.2919	-0.8534	0.6359	1.4750**	0.1942	0.1740	-0.1472
N	133	133	133	133	133	133	133	133
R-square	0.0910	0.0016	0.1941	0.0028	0.0164	0.0083	0.0131	0.1974
F(32,94)	2.32	7.13	11.31	2.39	4.70	9.91	9.77	1.69
Prob>F	0.0009	0.0000	0.0000	0.0006	0.0000	0.0000	0.0000	0.0268
Fixed Effects	Year, Country	Year, Country	Year, Country	Year, Country	Year, Country	Year, Country	Year, Country	Year, Country
F test that all u _i =0: F(6, 94)	3.64	19.53	13.86	16.37	46.67	34.52	33.85	39.48
Prob>F	0.0027	0.0000	0.0000	0.0000	0.0000	0.0000	0.0000	0.0000

Source: Estimated by the author and data processed with Stata 15.

Notes: ***, **, * : significance levels of 1%, 5%, and 10%, respectively highlighted in red.

APPENDIX 4.G. Feasible Generalized Least Squares regression

Table 4.14: FGLS regression using and interaction with FCT (With control variables)

Cross-sectional time-series FGLS regression

Coefficients: generalized least squares

Panels: heteroskedastic with cross-sectional correlation

Correlation: panel-specific AR(1)

	DV=MEC	DV=LnQ	DV= LnV	DV=LogSrellog	DV= LnSeff	DV=LnN	DV=Lnn	DV=LnHHI
INRr	-0.0061	0.0955***	0.0137*	0.0073	0.0044	0.0233*	0.0236*	-0.0163***
MB	-0.0014	0.0001	0.0014	-0.0001	-0.0021	-0.0009	-0.0011	-0.0014
LnEXR	-0.0226	0.3972***	-0.0995***	0.1961***	0.4898***	-0.1816***	-0.1882***	-0.1728***
GDP _r	0.0042	-0.0156	0.0072	-0.0402	-0.0207	0.0038	0.0034	0.0039
CPI	0.0151	-0.0059	-0.0251*	0.0295	-0.0464	-0.0070	-0.0065	0.0112*
LnTBR	-0.3177	-0.2275	0.0713	0.2222	1.0960***	-0.1282	-0.2034	-0.0153
FCT	2.2897**	2.3138***	0.7875	0.0123	2.8966***	3.3273***	3.3566***	-0.4009
INR _r xFCT	0.0393	-0.0117	-0.0563***	0.0936**	-0.0241	-0.0040	-0.0041	0.0055
MB _r xFCT	-0.0146	-0.0099	0.0103	-0.0443***	-0.0121	-0.0002	-0.0007	-0.0009
LnEXR _r xFCT	0.0617	0.1206*	-0.0548	-0.1743***	-0.0539	0.0359	0.0341	0.0186
GDP _r xFCT	-0.0303*	0.0329**	0.0539***	0.0098	0.0332*	0.0028	0.0041	-0.0077
CPI _r xFCT	0.0569	-0.0143	0.0434	0.0320	0.0427	0.0185	0.0076	-0.0226
LnTBR _r xFCT	-1.4188*	-0.5317	0.7466	-0.3818	-0.4624	-0.3894	-0.3792	0.2473
LnMAC	0.0702	0.6949***	0.1610***	0.0957**	-0.0551	0.0345	0.0340	0.0743***
FIG	-0.3450	-1.3556***	-1.2356***	2.3720***	0.9594***	-1.4044***	-1.5181***	0.3647**
N	133	133	133	133	133	133	133	133
Wald chi2(32)	5437.19	2409.90	4233.25	942.83	5879.40	3323.60	3201.33	793.46
Prob > chi2	0.0000	0.0000	0.0000	0.0000	0.0000	0.0000	0.0000	0.0000

Source: Estimated by the author and data processed with Stata 15.

Notes: ***, **, * : significance levels of 1%, 5%, and 10%, respectively highlighted in red.

CHAPTER 5: APPENDICES

APPENDIX 5.A. Causal linkage between monetary policy and stock market liquidity in EMEs and hypotheses

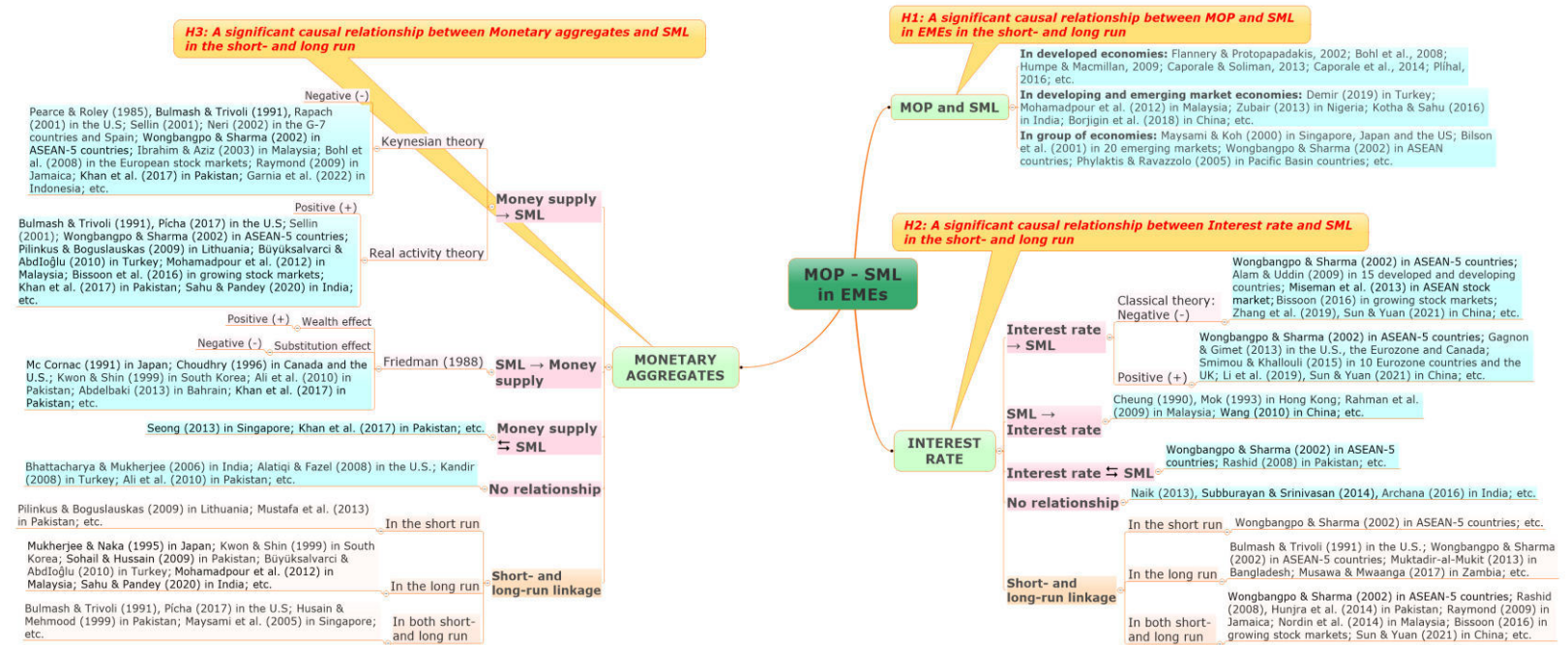

Figure 5.1: Causal linkage between monetary policy and stock market liquidity in EMEs and hypotheses (H1, H2 and H3)

Source: Summarised by the author.

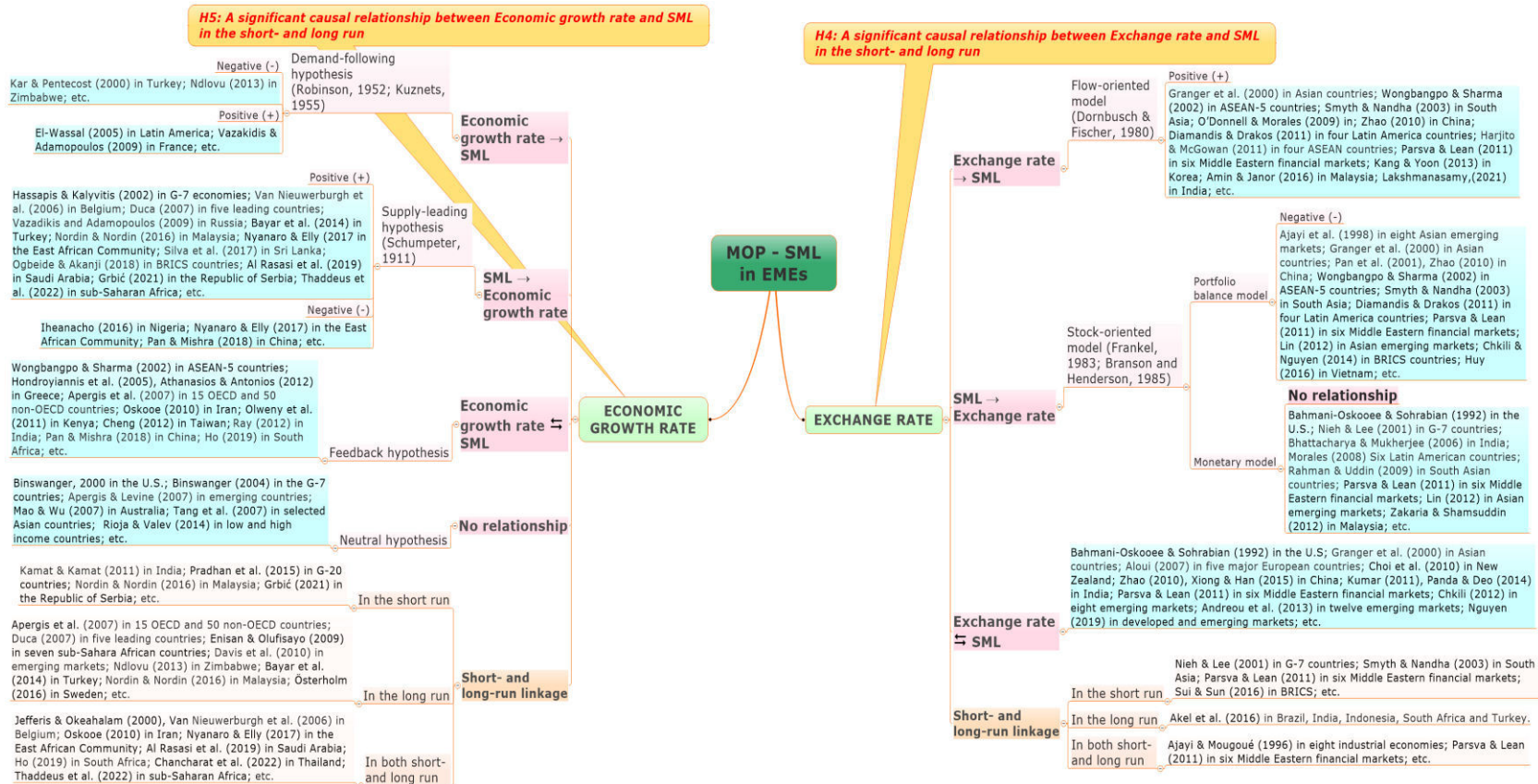

Figure 5.2: Causal linkage between monetary policy and stock market liquidity in EMEs and hypotheses (H4 and H5)

Source: Summarised by the author.

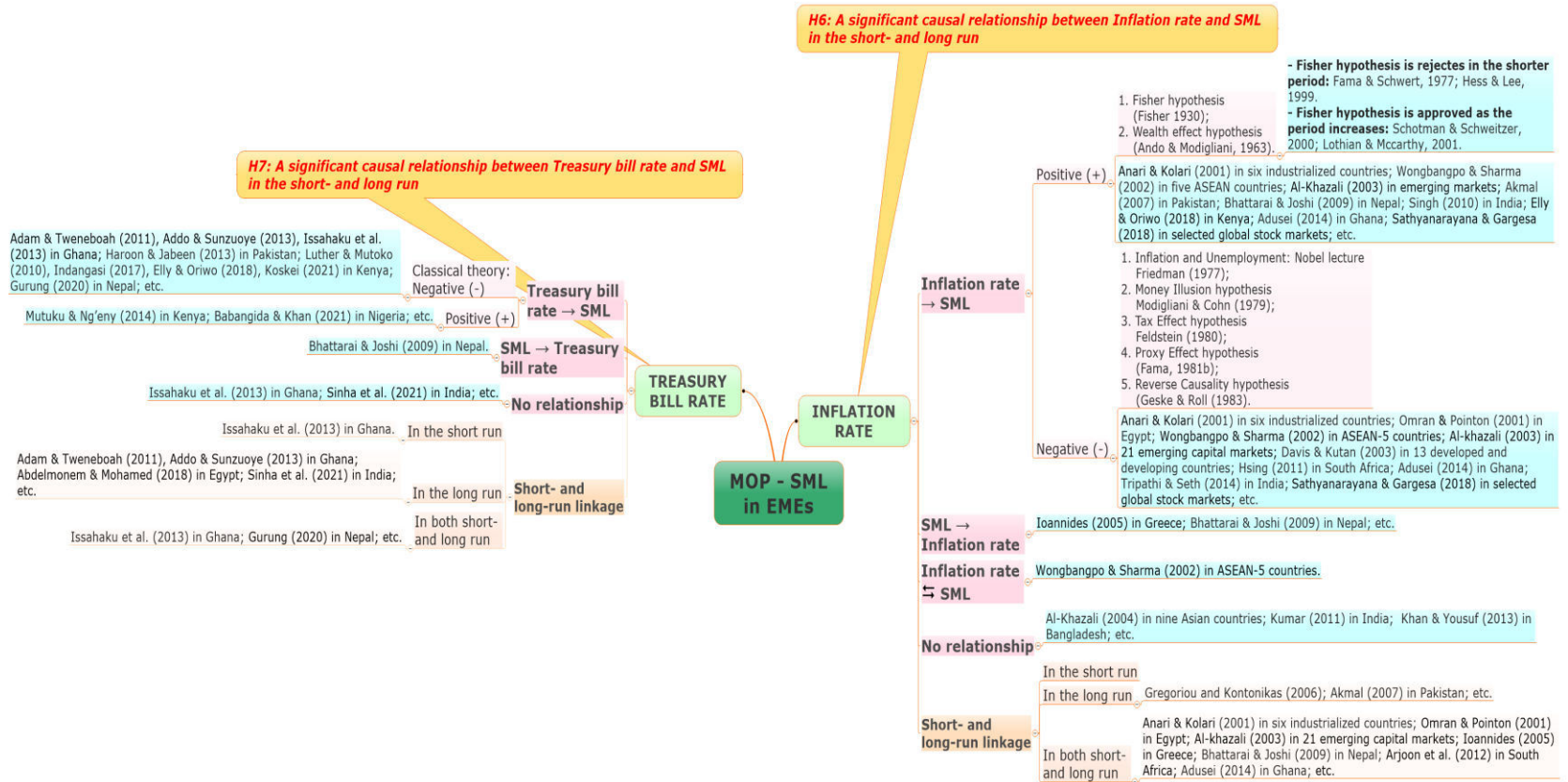

Figure 5.3: Causal linkage between monetary policy and stock market liquidity in EMEs and hypotheses (H6 and H7)

Source: Summarised by the author.

APPENDIX 5.B. Description of analysis strategy

1. Stationarity test (Panel unit root test - PURT)

The first-generation panel unit root tests⁸ employed in this study includes the Breitung test (Breitung, 2000), the LLC test (Levin et al., 2002), the IPS test (Im et al., 2003) and the Hadri LM (Hadri, 2000) that are all based on the assumption of independent cross-section series (see Table 5.1).

Table 5.1: Summary of the first-generation panel unit root tests and formulas

Test	Option	Asymptotics	Formula
Breitung	Constant	$(T, N) \rightarrow_{\text{seq}} \infty$	$\lambda = \frac{\sum_{i=1}^N \sum_{t=p+2}^T y_{it}^{\ell} \cdot \Delta y_{it} / \sigma_i^2}{\sqrt{\sum_{i=1}^N \sum_{t=p+2}^T (y_{it}^{\ell})^2 / \sigma_i^2}}$
	Trend	$(T, N) \rightarrow_{\text{seq}} \infty$	$\lambda = \frac{\sum_{i=1}^N \sum_{s=1}^{T-p-1} v_{is}^{\ell} \Delta v_{is} / \sigma_i^2}{\sqrt{\sum_{i=1}^N \sum_{s=1}^{T-p-1} (v_{is}^{\ell})^2 / \sigma_i^2}}$
LLC	Constant	$N/T \rightarrow 0$	$t_{\delta}^* = \frac{t_{\delta} - N\tilde{T}\widehat{S}_N \text{se}(\widehat{\delta}) \mu_{\tilde{T}}^*}{\sigma_{\tilde{T}}^*}$
	Trend	$N/T \rightarrow 0$	
IPS	Constant	$(T, N) \rightarrow_{\text{seq}} \infty$	$Z_{\tilde{t}\text{-bar}} = \frac{\sqrt{N} \{ \tilde{t}\text{-bar}_{NT} - N^{-1} \sum_{i=1}^N E(\tilde{t}_{Ti}) \}}{\sqrt{N^{-1} \sum_i \text{Var}(\tilde{t}_{Ti})}}$
	Trend	$(T, N) \rightarrow_{\text{seq}} \infty$	
Hadri LM	Constant	$(T, N) \rightarrow_{\text{seq}} \infty$	$\widehat{\text{LM}} = \frac{\frac{1}{N} \sum_i \frac{1}{T^2} \sum_t S_{it}^2}{\widehat{\sigma}_{\epsilon}^2}$
	Trend	$(T, N) \rightarrow_{\text{seq}} \infty$	

Source: <https://www.stata.com/manuals/xtxtunitroot.pdf>

Note: Descriptions of each variable and explanations are indicated in <https://www.stata.com/manuals/xtxtunitroot.pdf>.

⁸ See <https://www.stata.com/manuals/xtxtunitroot.pdf>.

A simple panel-data model with a first-order autoregressive component is considered in the Equation (5.2) as follows.

$$y_{it} = \rho_i y_{i,t-1} + z'_{it} + \varepsilon_{it} \quad (5.2)$$

The second-generation panel unit root test will be more reliable if cross-sectional dependence is detected. The second-generation test that the author proceeds in this study are “Pesaran CD Test” (Pesaran, 2007). The Cross-Sectional Augmented Dickey-Fuller (CADF) test belongs to the second-generation panel unit root tests and enables the independence issue. To solve the cross-sectional dependency problem, a standard Dickey-Fuller regression is enlarged by the cross-sectional mean and first differences of the lagged values of each series in the panel (see Equation (5.3)).

$$\Delta y_{i,t} = \alpha_i + \beta_i y_{i,t-1} + \gamma_i \bar{y}_{t-1} + \delta_i \Delta \bar{y}_i + \varepsilon_{i,t} \quad (5.3)$$

The null hypothesis of the CADF test detects nonstationarity for all series. If variables are cross-sectionally dependent and non-stationary at level, it is essential to confirm the presence of cointegration.

2. Cross-sectional dependence test

The Breusch-Pagan Lagrange multiplier test (the LM test) statistics show notable size distortion when $T < N$ (Pesaran, 2004). For N fixed and $T \rightarrow \infty$, (Breusch & Pagan, 1980) proposed an LM test to test the null hypothesis of no cross-sectional correlation without imposing any structure on this correlation. It is given by the Equation (5.4) below:

$$LM_{BP} = T \sum_{i=1}^{N-1} \sum_{j=i+1}^N \hat{\rho}_{ij}^2 \quad (5.4)$$

LM_{BP} is asymptotically distributed as a Chi-squared distribution with $N(N-1)/2$ degrees of freedom under the null.

Pesaran (2004) proposed a scaled version of this LM test in the Equation (5.5) as follows.

$$LM_p = \sqrt{\frac{1}{N(N-1)} \sum_{i=1}^{N-1} \sum_{j=i+1}^N (T\hat{\rho}_{ij}^2 - 1)} \quad (5.5)$$

Pesaran (2004) suggested the Pesaran's cross-sectional dependence test (the CD test) for various panel data models such as balanced and unbalanced, stationary and non-stationary dynamic heterogeneous panels, and robust in small and large samples. The CD test statistic is defined in the Equation (5.6) as follows.

$$CD = \sqrt{\frac{2T}{N(N-1)} \left(\sum_{i=1}^{N-1} \sum_{j=i+1}^N \hat{\rho}_{ij} \right)} \quad (5.6)$$

Rejection in the null hypothesis of the CD test reflects the interdependence of units and the null hypothesis assumes the nonexistence of cross-sectional dependence.

3. Panel cointegration test⁹

The *Kao cointegration tests* (Kao, 1999) propose Dickey-Fuller and Augmented Dickey-Fuller tests to investigate the cointegration links between homogeneous and heterogeneous panels. In the first step of the Kao cointegration tests, the regression is assumed to intercept specific cross-sections, and homogeneous coefficients for variables are estimated in the Equation (5.7).

$$y_{it} = \alpha_i + \delta_i t + \beta_{1i} X_{1,it} + \beta_{2i} X_{2,it} + \dots + \beta_{ni} X_{n,it} + \varepsilon_{it} \quad (5.7)$$

After that, the test statistics are obtained from the residuals in the Equation (5.8) as follows.

$$\varepsilon_{it} = \rho \varepsilon_{it-1} + v_{it} \quad (5.8)$$

⁹ See <https://www.stata.com/manuals/xtxtcointest.pdf>.

$$\varepsilon_{it} = \bar{\rho}\varepsilon_{it-1} + \sum_{j=1}^{\rho} \psi_j'' \varepsilon_{it-j} + v_{it} \quad (5.9)$$

Regression of Equation (5.8) is used for Dickey-Fuller test statistics, and its augmented version presented in the Equation (5.9) is applied for Augmented Dickey-Fuller tests. Within the null hypothesis for these tests “of no cointegration,” the residuals obtained as described above are assumed to be I(1). Therefore, if variables are cointegrated, and the null hypothesis is rejected, the residuals will be I(0).

The Pedroni cointegration tests (Pedroni, 1999, 2004) enable heterogeneous intercepts and trend coefficients between individual cross-sections. In this framework, “the null hypothesis of absence cointegration” is tested using panel and group mean tests. The Pedroni panel cointegration regression allowing for cross-section interdependence with different individual effects is specified in the Equation (5.10) as follows.

$$y_{it} = \delta_{1i} + \delta_{2i}t + x'_{it}\beta_i + \varepsilon_{it} \quad (5.10)$$

In the null hypothesis of Pedroni’s cointegration tests, the residuals ε_{it} consider as integrated of order on I(1). The rejection of the null hypothesis of Pedroni’s cointegration tests is interpreted as the existence of cointegration across tested variables or as there are some equilibrium relations across series in the long-run period.

The Westerlund cointegration tests (Westerlund, 2007) suggests cointegration tests that are an extension of Banerjee et al. (2005). These tests are relied on structural rather than residual dynamics and allow for a significant degree of heterogeneity. All variables are assumed to be I(1). It tests the same null hypothesis as the Kao and Pedroni tests, but the alternative hypothesis is different: some (not necessarily all) of the panels are cointegrated. The Westerlund panel cointegration test based on the ECM is expressed in the Equation (5.11) as follows.

$$\Delta y_{it} = \phi'_i d_t + \alpha_i y_{it-1} + \phi'_i x_{it-1} + \sum_{j=1}^{pi} \alpha_{ij} \Delta y_{it-j} + \sum_{j=0}^{pi} \theta_{ij} \Delta x_{it-j} + \varepsilon_{it} \quad (5.11)$$

4. Granger causality test (Lopez & Weber, 2017)

The Granger causality approach (Granger, 1969) only analysed the causal relationships between time series in terms of the causal relationship. It assumes there is causality for all individuals in the time series. A typical Granger model is in the Equation (5.12) as follows.

$$y_t = \alpha + \sum_{k=1}^K \gamma_k y_{t-k} + \sum_{k=1}^K \beta_k x_{t-k} + \varepsilon_t \quad (5.12)$$

with $t=1, \dots, T$

In panel data which includes many individuals and periods, Dumitrescu & Hurlin (2012) developed a procedure to detect causality in panel data with the extended models in the Equation (5.13) below.

$$y_{i,t} = \alpha_i + \sum_{k=1}^K \gamma_{ik} y_{i,t-k} + \sum_{k=1}^K \beta_{ik} x_{i,t-k} + \varepsilon_{it} \quad (5.13)$$

with $i=1, \dots, N$ and $t=1, \dots, T$

where: $x_{i,t}$ and $y_{i,t}$ are observations of two static variables for individual i at time t .

The Dumitrescu & Hurlin test (the DH test) assumes there can be the causality for some individuals but no need for all. Hence, Dumitrescu & Hurlin (2012) do not use F-test but rely on the standardized statistic (\bar{Z}) and the approximately standardized statistic (\tilde{Z}), which are the standard scores of W_i , the standard adjusted Wald statistics for individual i observed during T periods. If Z-scores are more significant than the corresponding typical critical values, then H_0 should be rejected and conclude that there is Granger causality.

The author only reveals the causality between MOP and SML variables using the DH test without considering any other control variables. Due to the restricted period, the maximum number of lags in this study is four

lags¹⁰, and the DH models of this study must be from the Equation (5.14) to Equation (5.19) as follows.

$$SML_{i,t} = \alpha_i + \gamma_i SML_{i,t-1} + \beta_i MOP_{i,t-1} + \varepsilon_{it} \quad (5.14)$$

$$SML_{i,t} = \alpha_i + \gamma_i SML_{i,t-1} + \beta_i LnMAC_{i,t-1} + \varepsilon_{it} \quad (5.15)$$

$$SML_{i,t} = \alpha_i + \gamma_i SML_{i,t-1} + \beta_i FIG_{i,t-1} + \varepsilon_{it} \quad (5.16)$$

$$MOP_{i,t} = \alpha_i + \gamma_i MOP_{i,t-1} + \beta_i SML_{i,t-1} + \varepsilon_{it} \quad (5.17)$$

$$LnMAC_{i,t} = \alpha_i + \gamma_i LnMAC_{i,t-1} + \beta_i SML_{i,t-1} + \varepsilon_{it} \quad (5.18)$$

$$FIG_{i,t} = \alpha_i + \gamma_i FIG_{i,t-1} + \beta_i SML_{i,t-1} + \varepsilon_{it} \quad (5.19)$$

5. CS-ECM estimation (Ditzen, 2021)

The CS-ECM follows on the lines of Lee et al. (1997) and Pesaran et al. (1999), in which Equation (5.20) is transformed into the ECM of the Equation (5.21) as follows.

$$y_{i,t} = \mu_i + \lambda_i y_{i,t-1} + \beta_{0,i} x_{i,t} + \beta_{1,i} x_{i,t-1} + u_{i,t} \quad (5.20)$$

with $i = 1, \dots, N$ and $t = 1, \dots, T_i$

$$\Delta y_{i,t} = \mu_i - \phi_i [y_{i,t-1} - \theta_{1,i} x_{i,t}] - \beta_{1,i} \Delta x_{i,t} + \sum_{l=0}^{PT} \gamma'_{i,l} \bar{z}_{t-l} + \varepsilon_{i,t} \quad (5.21)$$

with Δ the first difference operator.

$\theta_i = \frac{\beta_{0,i} + \beta_{1,i}}{1 - \lambda_i}$. The long-term or equilibrium effect is captured by θ_i and it measures how the equilibrium changes.

$\phi_i = (1 - \lambda_i)$ is the error-correction speed of adjustment parameter and represents how fast the adjustment appears. The long-term relationship exists if $\phi_i \neq 0$ (Pesaran et al., 1999).

$[y_{i,t-1} - \theta_{1,i} x_{i,t}]$ is the error correction term.

$\beta_{0,i}$ captures the immediate or short-term effect of $x_{i,t}$ on $y_{i,t}$.

¹⁰ Note that the maximum authorized number of lags is such that $T > 5+3.K$, where T is the number of observations remaining in the estimations, measured by the number of periods minus the number of lags included; K is the number of lags.

In this study, the long-term cointegrating regression model and the ARDL scheme (see Equation (5.22)) following the conventional CS-ECM for cointegrating variables can be identified in the Equation (5.23) as follows.

$$SML_{i,t} = \mu_i + SML'_{i,t}\lambda + MOP'_{i,t}\beta + MAC_{i,t}\beta + FIG_{i,t}\beta + u_{i,t} \quad (5.22)$$

$$\begin{aligned} \Delta SML_{i,t} = \mu_i - \phi_i [SML'_{i,t-1} - MOP'_{i,t}\theta - MAC_{i,t}\theta - FIG_{i,t}\theta] \\ - \Delta MOP'_{i,t}\beta - \Delta MAC_{i,t}\beta - \Delta FIG_{i,t}\beta + \varepsilon_{i,t} \end{aligned} \quad (5.23)$$

APPENDIX 5.C. Descriptive analysis

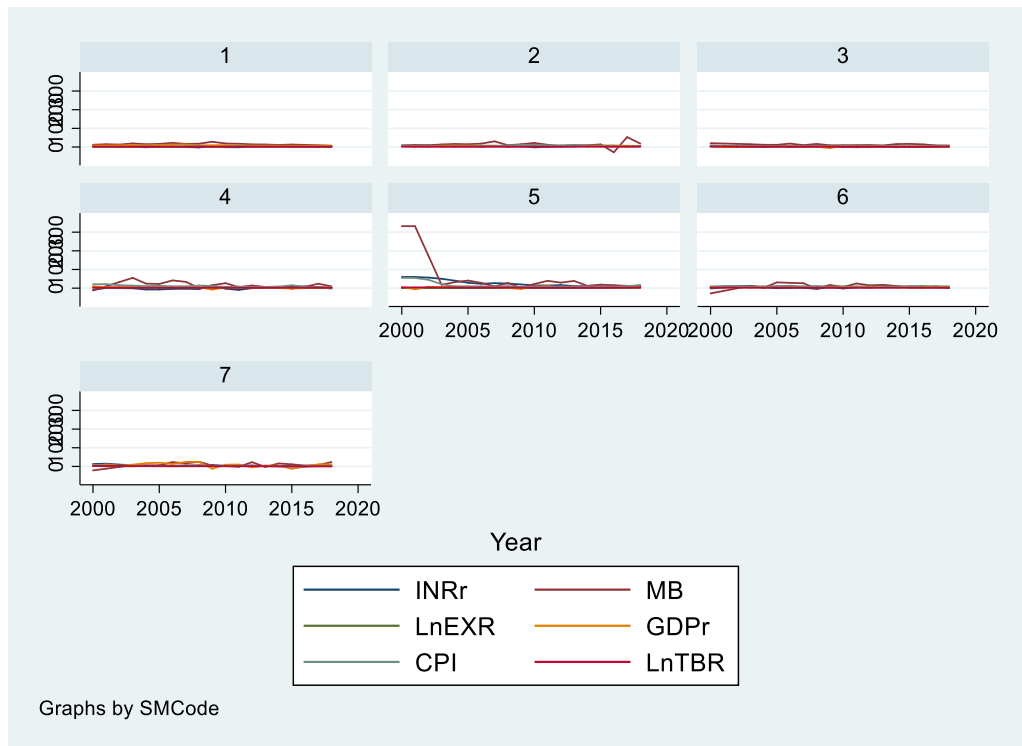

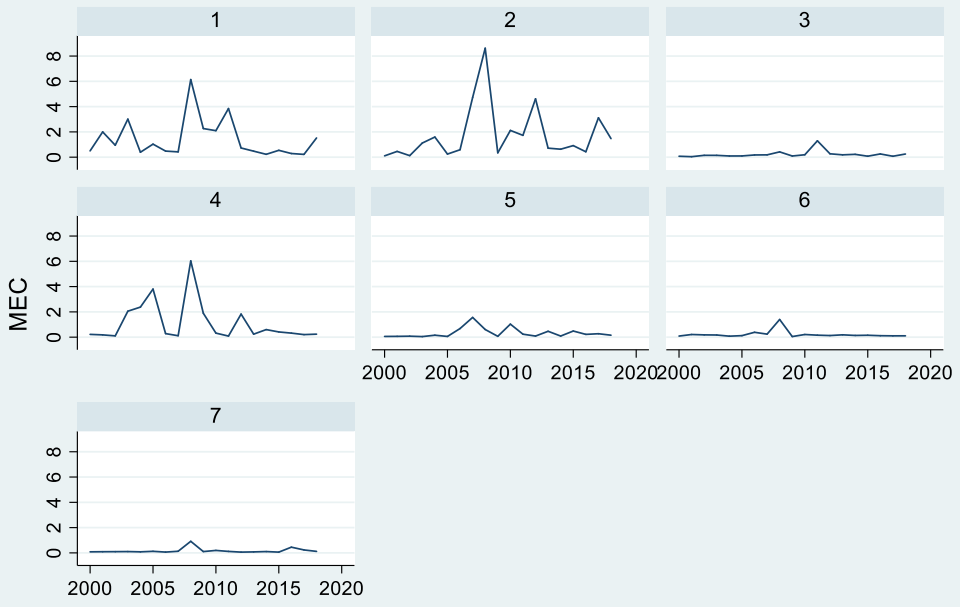

Graphs by SMCode

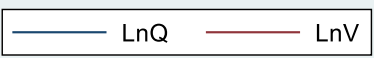
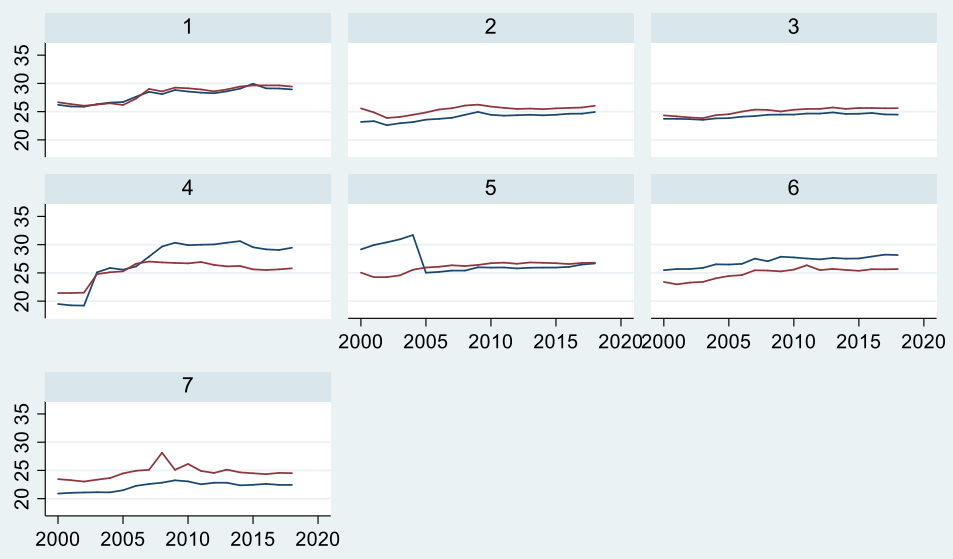

Graphs by SMCode

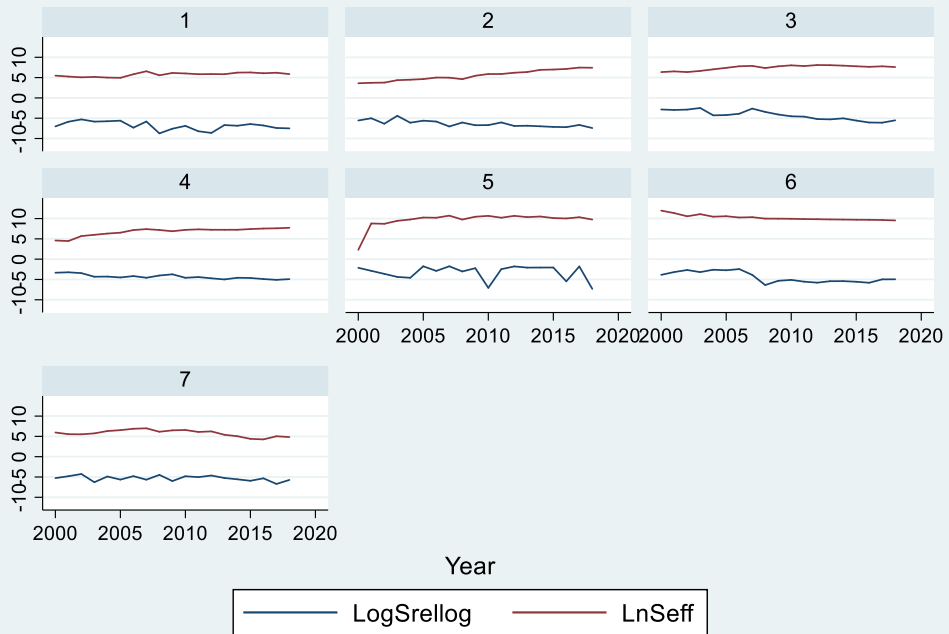

Graphs by SMCode

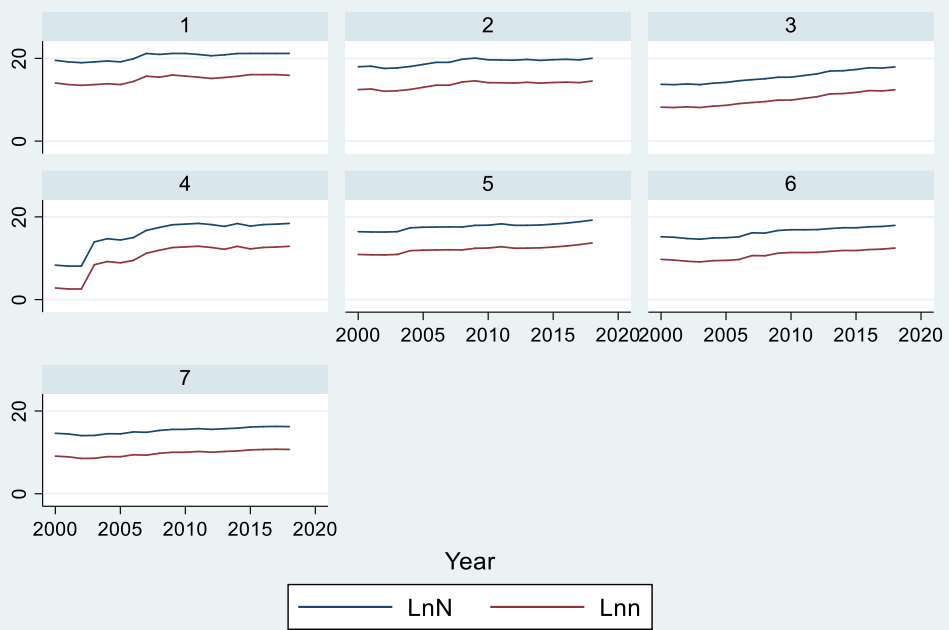

Graphs by SMCode

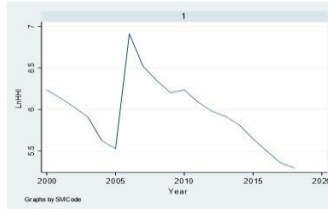
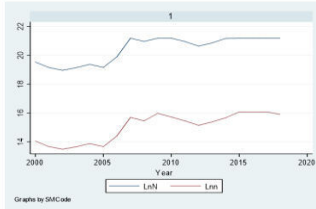
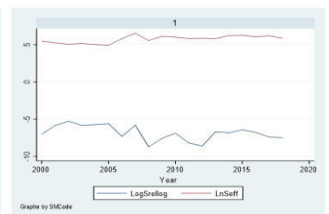
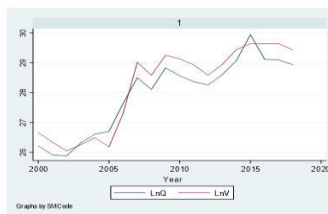
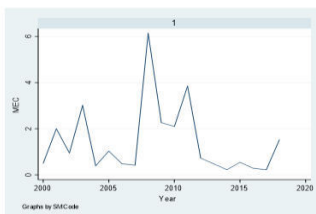
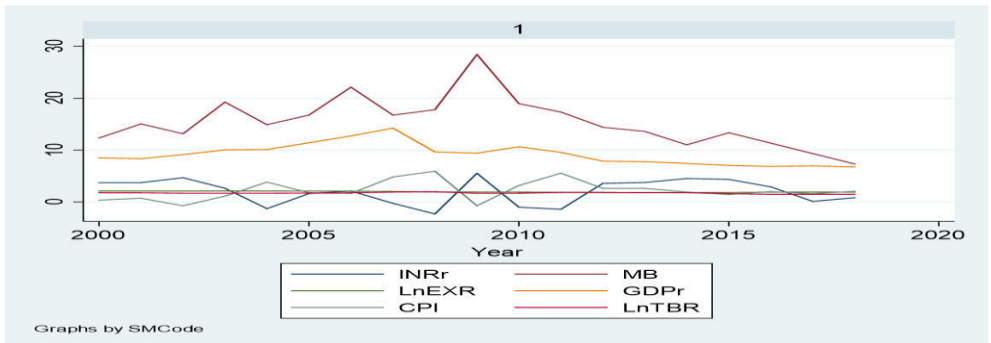
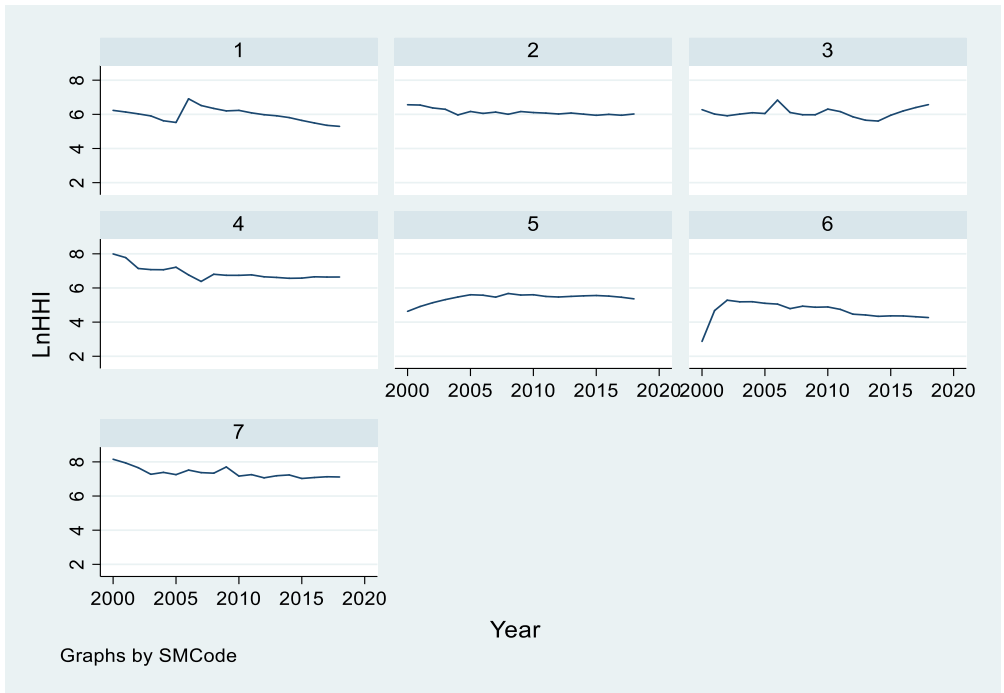

MOP and SML in CHINA

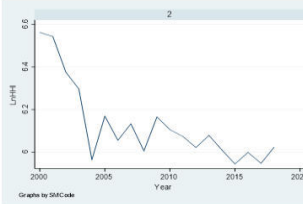
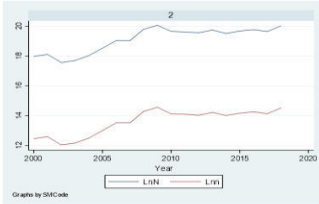
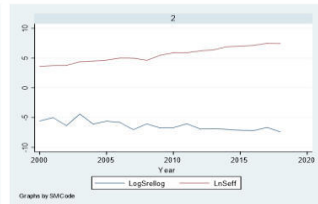
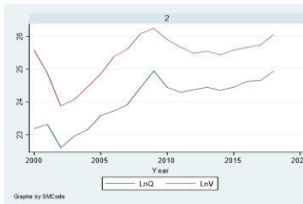
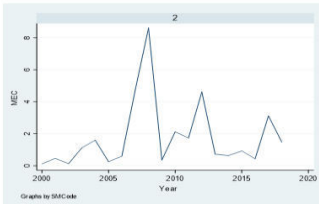
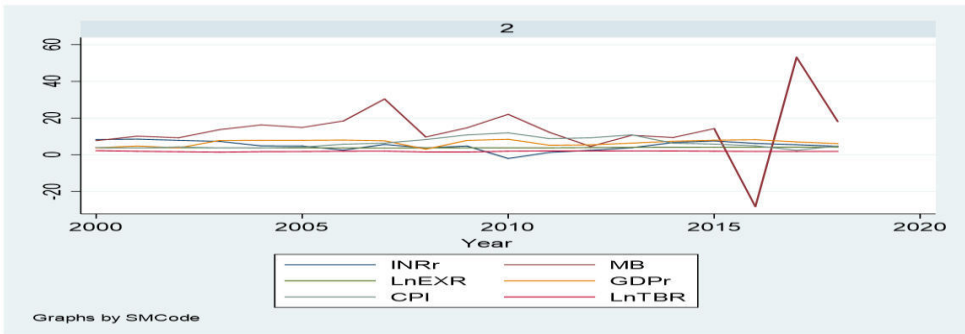

MOP and SML in INDIA

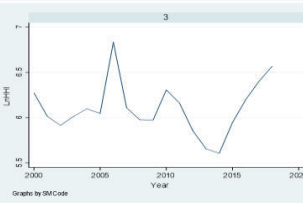
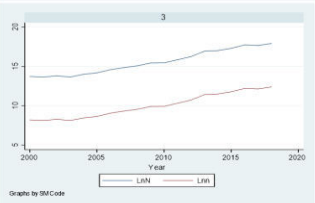
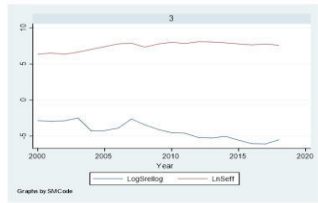
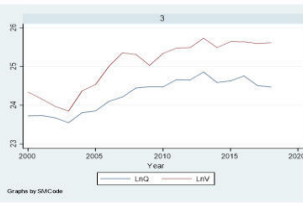
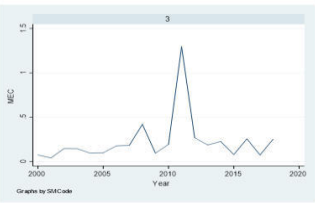
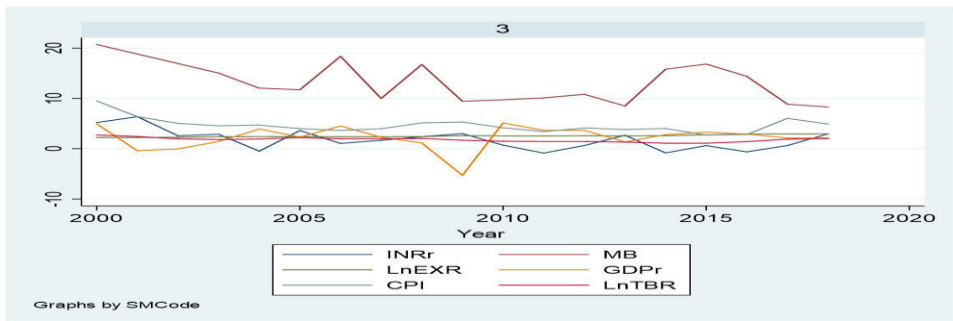

MOP and SML in MEXICO

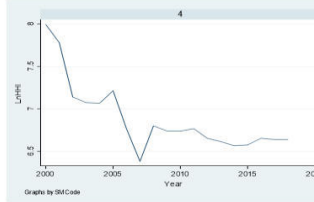
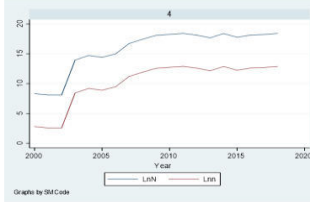
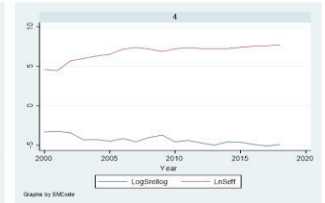
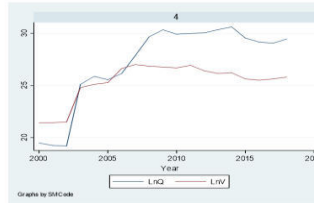
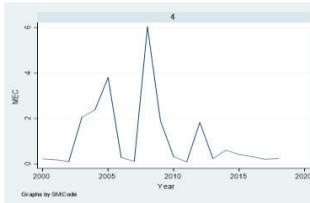
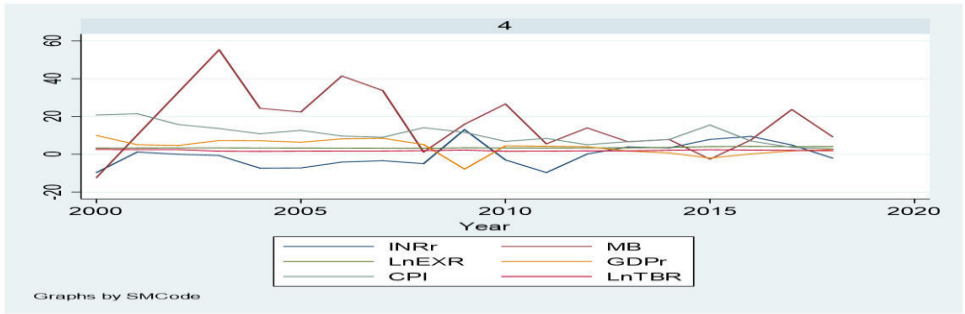

MOP and SML in RUSSIA

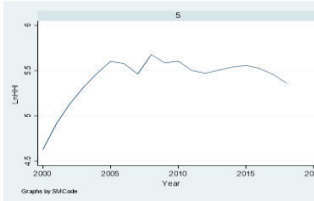
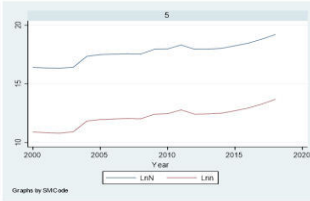
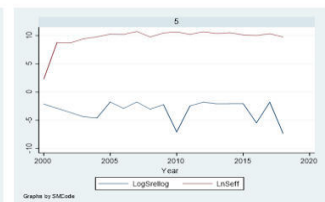
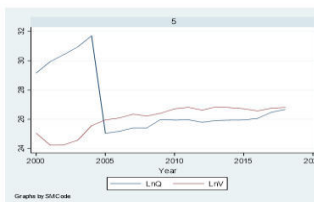
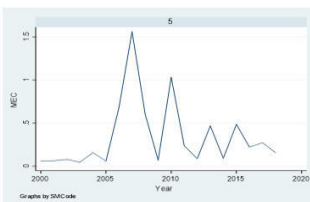
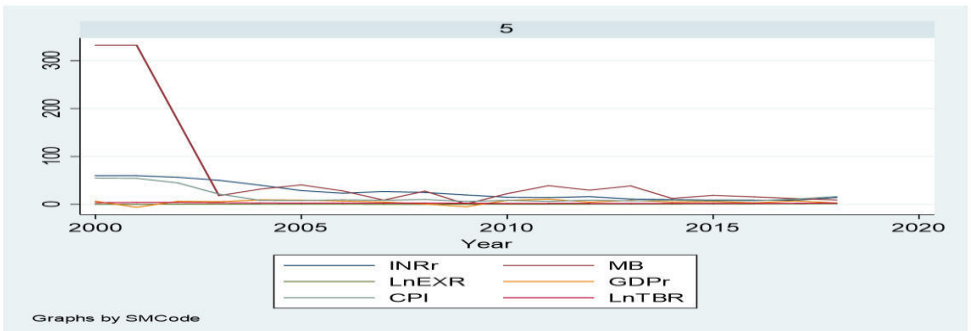

MOP and SML in TURKEY

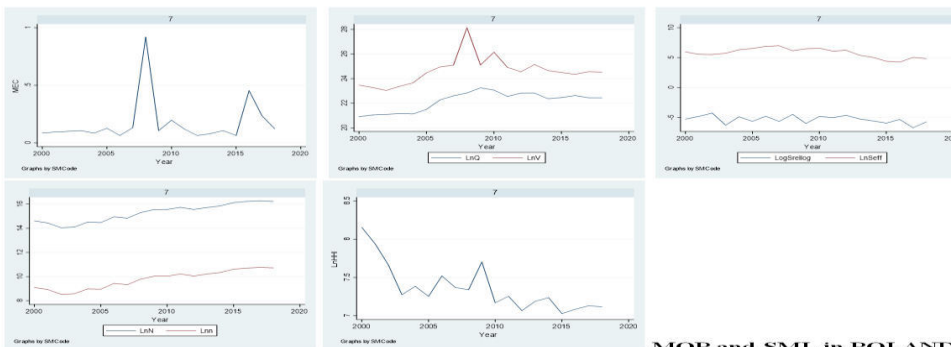
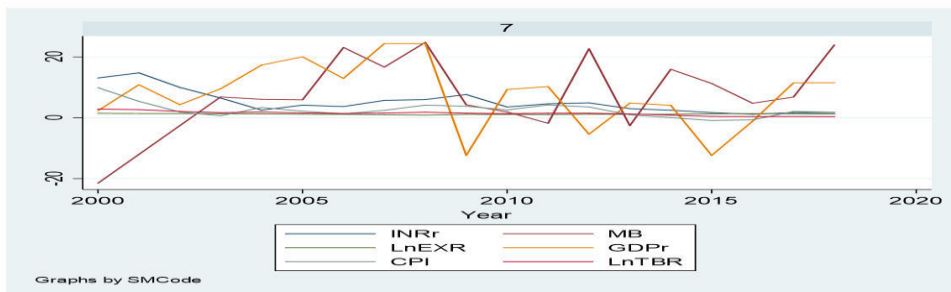
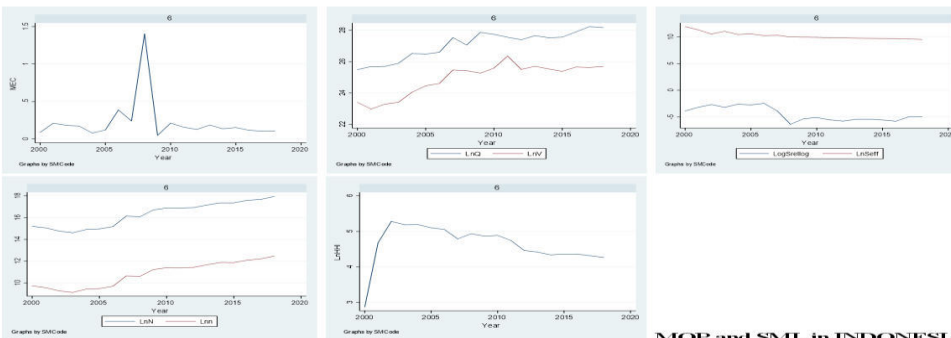
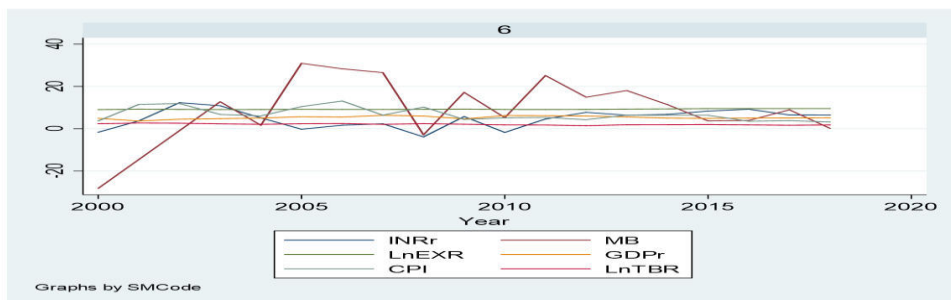

Figure 5.4: Trend of MOP and SML in seven selected countries of EMEs from 2000 to 2018

Source: Estimated by the author and data processed with Stata 15.

Note: 1. Monetary policy: INRr, MB, EXR, GDPPr, CPI and TBR.
 2. Stock market liquidity characteristics: ReM (MEC); DeM (LnQ and LnV); TiM (LogSrellog and LnSeff); ImM (LnN and Lnn); and DiM (LnHHI).

APPENDIX 5.D. Stationarity test

Table 5.2: First-generation panel unit root tests for each variable

(Cross-sectional independence)

Panel unit root test	Variables	For constant and no trend		For constant and trend		Stationary state	
		(1)	(2)	(1)	(2)	(1)	(2)
Method	Variables	Statistic	Prob.	Statistic	Prob.	(1)	(2)
Breitung t-stat^a							
	MEC	-6.2568	0.0000	-5.9698	0.0000	Yes	Yes
	LnQ	0.7314	0.7677	-0.3391	0.3673	No	No
	LnV	0.0708	0.5282	-1.0830	0.1394	No	No
	LogSrellog	-2.0408	0.0206	-4.0602	0.0000	Yes	Yes
	LnSeff	1.5551	0.9400	-0.1782	0.4293	No	No
	LnN	3.2020	0.9993	-1.2239	0.1105	No	No
	Lnn	3.2320	0.9994	-1.1642	0.1222	No	No
	LnHHI	-0.0580	0.4769	0.5598	0.7122	No	No
	INRr	-0.0796	0.4683	-0.4269	0.3347	No	No
	MB	-1.0215	0.1535	-1.3314	0.0915	No	Yes
	LnEXR	2.5846	0.9951	1.5802	0.9430	No	No
	GDPr	-4.0861	0.0000	-3.7912	0.0001	Yes	Yes
	CPI	-0.5594	0.2879	0.1229	0.5489	No	No
	LnTBR	-0.1255	0.4501	0.4745	0.6824	No	No
	LnMAC	0.8462	0.8013	-1.5962	0.0552	No	Yes
	FIG	-2.9270	0.0017	-1.6946	0.0451	Yes	Yes
Levin, Lin & Chu t (LLC)^b							
	MEC	-8.1463	0.0000	-7.1591	0.0000	Yes	Yes
	LnQ	-6.2394	0.0000	-0.3117	0.3776	Yes	No
	LnV	-0.9691	0.1663	-6.0607	0.0000	No	Yes
	LogSrellog	-1.9532	0.0254	-0.9234	0.1779	Yes	No
	LnSeff	-7.1376	0.0000	-9.6552	0.0000	Yes	Yes
	LnN	-2.8084	0.0025	-1.4876	0.0684	Yes	Yes
	Lnn	-2.7870	0.0027	-1.2994	0.0969	Yes	Yes
	LnHHI	-7.0247	0.0000	-1.0495	0.1470	Yes	No
	INRr	-5.5877	0.0000	-2.4019	0.0082	Yes	Yes
	MB	-4.4606	0.0000	-3.8025	0.0001	Yes	Yes
	LnEXR	2.4598	0.9930	0.0301	0.5120	No	No
	GDPr	-5.0921	0.0000	-5.3288	0.0000	Yes	Yes
	CPI	-4.6072	0.0000	-2.8822	0.0020	Yes	Yes
	LnTBR	-2.1190	0.0170	-1.5530	0.0602	Yes	Yes
	LnMAC	-4.0148	0.0000	-1.7933	0.0365	Yes	Yes
	FIG	-4.1863	0.0000	-4.0790	0.0000	Yes	Yes
Im-Pesaran-Shin W-stat (IPS)^c							
	MEC	-6.4729	0.0000	-4.7111	0.0000	Yes	Yes
	LnQ	-3.0764	0.0010	1.6281	0.9482	Yes	No
	LnV	-0.2104	0.4167	-1.7813	0.0374	No	Yes

	LogSrellog	-1.7341	0.0415	-2.3228	0.0101	Yes	Yes
	LnSeff	-6.1316	0.0000	-6.1503	0.0000	Yes	Yes
	LnN	-0.2068	0.4181	-0.8420	0.1999	No	No
	Lnn	-0.1599	0.4365	-0.8194	0.2063	No	No
	LnHHI	-5.7055	0.0000	-1.6253	0.0520	Yes	Yes
	INRr	-4.3724	0.0000	-2.2201	0.0132	Yes	Yes
	MB	-4.5538	0.0000	-3.1671	0.0008	Yes	Yes
	LnEXR	3.8751	0.9999	2.1941	0.9859	No	No
	GDPPr	-4.5492	0.0000	-3.6577	0.0001	Yes	Yes
	CPI	-4.3599	0.0000	-1.8711	0.0307	Yes	Yes
	LnTBR	-1.2899	0.0985	-0.9968	0.1594	Yes	No
	LnMAC	-1.0734	0.1415	0.1930	0.5765	No	No
	FIG	-3.3049	0.0005	-3.2541	0.0006	Yes	Yes
Hadri Z-stat (LM)^d							
	MEC	-0.0063	0.5025	2.9059	0.0018	Yes	No
	LnQ	19.1744	0.0000	15.1815	0.0000	No	No
	LnV	16.2940	0.0000	15.2320	0.0000	No	No
	LogSrellog	9.6723	0.0000	1.1756	0.1199	No	Yes
	LnSeff	15.2528	0.0000	9.8124	0.0000	No	No
	LnN	22.6816	0.0000	16.2899	0.0000	No	No
	Lnn	22.6971	0.0000	6.1402	0.0000	No	No
	LnHHI	8.0365	0.0000	7.4226	0.0000	No	No
	INRr	20.8168	0.0000	9.2098	0.0000	No	No
	MB	10.5530	0.0000	11.1967	0.0000	No	No
	LnEXR	19.9796	0.0000	17.4011	0.0000	No	No
	GDPPr	2.7852	0.0027	1.3700	0.0854	No	No
	CPI	12.3315	0.0000	14.0257	0.0000	No	No
	LnTBR	17.7521	0.0000	8.5636	0.0000	No	No
	LnMAC	23.3179	0.0000	10.7626	0.0000	No	No
	FIG	7.4072	0.0000	3.9156	0.0000	No	No

Source: Estimated by the author and data processed with Stata 15.

Note: ^{a, b} Null hypothesis: Panels contain unit roots; Ha: Panels are stationary (assumes common unit root process).

^c Null hypothesis: All panels contain unit roots; Ha: Some panels are stationary (assumes individual unit root process).

^d Null hypothesis: All panels are stationary; Ha: Some panels contain unit roots.

Table 5.3: Second-generation panel unit root test for each variable

Pesaran's CADF test $Z[\bar{t}]$: H0: All series are non-stationary; Ha: Some panels are stationary

Variables	For constant and no trend (1)		For constant and trend (2)		Stationary state	
	Statistic	P-value	Statistic	P-value	(1)	(2)
MEC	-1.691	0.540	-2.043	0.733	No	No
LnQ	-0.711	0.996	-1.509	0.978	No	No

LnV	-1.689	0.542	-1.836	0.878	No	No
LogSrellog	-1.060	0.957	-1.873	0.857	No	No
LnSeff	-1.188	0.918	-1.498	0.980	No	No
LnN	-0.919	0.981	-2.278	0.502	No	No
Lnn	-1.229	0.901	-2.960	0.038	No	Yes
LnHHI	-0.596	0.998	-1.497	0.980	No	No
INRr	-2.584	0.014	-1.568	0.969	Yes	No
MB	-1.792	0.437	-1.509	0.978	No	No
LnEXR	-1.089	0.950	-3.497	0.001	No	Yes
GDPr	-1.431	0.779	-0.213	1.000	No	No
CPI	-1.020	0.966	-0.575	1.000	No	No
LnTBR	-1.874	0.355	-1.835	0.878	No	No
LnMAC	-0.669	0.997	-1.541	0.974	No	No
FIG	-0.408	1.000	-1.829	0.881	No	No

Source: Estimated by the author and data processed with Stata 15.

APPENDIX 5.E. Cross-sectional dependency test

**Table 5.4: Cross-sectional dependency test for each SML variable
(Breusch-Pagan LM test)**

Variables	chi2 (21)	Pr	
MEC	84.791	0.0000	Cross-sectional correlation
LnQ	48.930	0.0005	Cross-sectional correlation
LnV	58.360	0.0000	Cross-sectional correlation
LogSrellog	33.866	0.0375	Cross-sectional correlation
LnSeff	63.178	0.0000	Cross-sectional correlation
LnN	62.663	0.0000	Cross-sectional correlation
Lnn	65.137	0.0000	Cross-sectional correlation
LnHHI	61.249	0.0000	Cross-sectional correlation

Source: Estimated by the author and data processed with Stata 15.

Table 5.5: Cross sectional dependency test for each SML variable (CD test)

	Pesaran's test		
	Pesaran's test	Pr	Average absolute value of the off-diagonal elements
MEC	-2.057	0.0397	0.424
LnQ	-1.784	0.0744	0.302
LnV	-2.287	0.0222	0.337
LogSrellog	-2.855	0.0043	0.252
LnSeff	-2.980	0.0029	0.351
LnN	-1.521	0.1282	0.328
Lnn	-1.489	0.1366	0.336
LnHHI	-2.487	0.0129	0.322

Source: Estimated by the author and data processed with Stata 15.

APPENDIX 5.F. Panel cointegration test

Table 5.6: Cointegration test for MOP and SML variables

	Test statistic	For constant and no trend (1)		For constant and trend (2)		Cointegration state	
		Statistics	p-value	Statistics	p-value	(1)	(2)
Kao panel-data cointegration test^a							
MEC	Modified Dickey-Fuller t	0.8599	0.1949			No	
	Dickey-Fuller t	-0.9889	0.1614				
	Augmented Dickey-Fuller t	-0.4811	0.3152				
	Unadjusted modified Dickey-Fuller t	-10.5622***	0.0000				
	Unadjusted Dickey-Fuller t	-7.9147***	0.0000				
LnQ	Modified Dickey-Fuller t	1.3263*	0.0924			Yes	
	Dickey-Fuller t	-0.2235	0.4116				
	Augmented Dickey-Fuller t	-1.8534**	0.0319				
	Unadjusted modified Dickey-Fuller t	-2.1326**	0.0165				
	Unadjusted Dickey-Fuller t	-3.3449***	0.0004				
LnV	Modified Dickey-Fuller t	1.4928*	0.0677			No	
	Dickey-Fuller t	0.7796	0.2178				
	Augmented Dickey-Fuller t	0.0753	0.4700				
	Unadjusted modified Dickey-Fuller t	-1.2752	0.1011				
	Unadjusted Dickey-Fuller t	-1.8655**	0.0311				
LogSrellog	Modified Dickey-Fuller t	1.4633*	0.0717			Yes	
	Dickey-Fuller t	0.4916	0.3115				
	Augmented Dickey-Fuller t	2.5532***	0.0053				
	Unadjusted modified Dickey-Fuller t	-9.4002***	0.0000				
	Unadjusted Dickey-Fuller t	-6.5992***	0.0000				
LnSeff	Modified Dickey-Fuller t	1.4223*	0.0775			Yes	

	Dickey-Fuller t	0.4161	0.3387				
	Augmented Dickey-Fuller t	1.3635*	0.0864				
	Unadjusted modified Dickey-Fuller t	-0.9950	0.1599				
	Unadjusted Dickey-Fuller t	-1.9349**	0.0265				
LnN	Modified Dickey-Fuller t	0.6966	0.2430			Yes	
	Dickey-Fuller t	-1.1131	0.1328				
	Augmented Dickey-Fuller t	-3.6616***	0.0001				
	Unadjusted modified Dickey-Fuller t	-1.3738*	0.0848				
	Unadjusted Dickey-Fuller t	-2.7334***	0.0031				
Lnn	Modified Dickey-Fuller t	0.6793	0.2485			Yes	
	Dickey-Fuller t	-1.1293	0.1294				
	Augmented Dickey-Fuller t	-3.6615***	0.0001				
	Unadjusted modified Dickey-Fuller t	-1.3278*	0.0921				
	Unadjusted Dickey-Fuller t	-2.6950***	0.0035				
LnHHI	Modified Dickey-Fuller t	-2.7510***	0.0030			Yes	
	Dickey-Fuller t	-3.4231***	0.0003				
	Augmented Dickey-Fuller t	-1.7727**	0.0381				
	Unadjusted modified Dickey-Fuller t	-5.6885***	0.0000				
	Unadjusted Dickey-Fuller t	-4.4418***	0.0000				
Pedroni panel-data cointegration test^b							
MEC	<i>Within dimension test statistics</i>					Yes	Yes
	Panel v-Statistic	-3.2354***	0.0006	-4.2299***	0.0000		
	Panel rho-Statistic	1.4677*	0.0711	2.3288***	0.0099		
	Panel PP-Statistic	-5.0785***	0.0000	-6.0483***	0.0000		
	Panel ADF-Statistic	-4.7716***	0.0000	-5.6577***	0.0000		
	<i>Between-dimension test statistics</i>					Yes	Yes
	Group rho-Statistic	2.6324***	0.0042	3.2387***	0.0006		
	Group PP-Statistic	-4.7151***	0.0000	-5.8101***	0.0000		
	Group ADF-Statistic	-4.4600***	0.0000	-5.8210***	0.0000		

LnQ	<i>Within dimension test statistics</i>					Yes	Yes
	Panel v-Statistic	-3.3348***	0.0004	-3.9164***	0.0000		
	Panel rho-Statistic	2.5259***	0.0058	2.7165***	0.0033		
	Panel PP-Statistic	-0.0609	0.4757	-1.4634*	0.0717		
	Panel ADF-Statistic	0.1869	0.4259	-1.4090*	0.0794		
	<i>Between-dimension test statistics</i>					No	Yes
	Group rho-Statistic	3.3229***	0.0004	3.4309***	0.0003		
	Group PP-Statistic	-0.6333	0.2633	-1.7936**	0.0364		
	Group ADF-Statistic	-0.2467	0.4026	-1.3379*	0.0905		
LnV	<i>Within dimension test statistics</i>					Yes	Yes
	Panel v-Statistic	-3.2970***	0.0005	-3.7411***	0.0001		
	Panel rho-Statistic	3.1046***	0.0010	3.3359***	0.0004		
	Panel PP-Statistic	1.4017*	0.0805	0.5280	0.2987		
	Panel ADF-Statistic	-2.3067**	0.0105	-0.6890	0.2454		
	<i>Between-dimension test statistics</i>					Yes	No
	Group rho-Statistic	3.8252***	0.0001	4.0037***	0.0000		
	Group PP-Statistic	0.8957	0.1852	0.3083	0.3789		
	Group ADF-Statistic	-1.9149**	0.0278	0.1021	0.4593		
LogSrellog	<i>Within dimension test statistics</i>					Yes	Yes
	Panel v-Statistic	-3.0541***	0.0011	-3.8285***	0.0001		
	Panel rho-Statistic	0.9961	0.1596	1.6256*	0.0520		
	Panel PP-Statistic	-4.8658***	0.0000	-7.5313***	0.0000		
	Panel ADF-Statistic	-4.7487***	0.0000	-6.1093***	0.0000		
	<i>Between-dimension test statistics</i>					Yes	Yes
	Group rho-Statistic	1.8477**	0.0323	2.4554***	0.0070		
	Group PP-Statistic	-5.5654***	0.0000	-7.9052***	0.0000		
	Group ADF-Statistic	-6.0736***	0.0000	-7.4290***	0.0000		
LnSeff	<i>Within dimension test statistics</i>					Yes	Yes
	Panel v-Statistic	-3.9335***	0.0000	-3.9680***	0.0000		

	Panel rho-Statistic	2.2402**	0.0125	2.7297***	0.0032		
	Panel PP-Statistic	-1.0073	0.1569	-1.7121**	0.0434		
	Panel ADF-Statistic	-1.4086*	0.0795	-1.5420*	0.0615		
	<i>Between-dimension test statistics</i>					No	Yes
	Group rho-Statistic	3.3578***	0.0004	3.4865***	0.0002		
	Group PP-Statistic	-0.3475	0.3641	-1.9143**	0.0278		
	Group ADF-Statistic	0.2899	0.3860	-1.0895	0.1380		
LnN	<i>Within dimension test statistics</i>					Yes	Yes
	Panel v-Statistic	-3.5737***	0.0002	-3.7589***	0.0001		
	Panel rho-Statistic	2.6852***	0.0036	3.2129***	0.0007		
	Panel PP-Statistic	0.9122	0.1808	0.0812	0.4677		
	Panel ADF-Statistic	0.8097	0.2090	0.2724	0.3927		
	<i>Between-dimension test statistics</i>					Yes	No
	Group rho-Statistic	3.8925***	0.0000	3.9826***	0.0000		
	Group PP-Statistic	1.9656**	0.0247	0.3428	0.3659		
	Group ADF-Statistic	1.8179**	0.0345	0.4896	0.3122		
Lnn	<i>Within dimension test statistics</i>					Yes	Yes
	Panel v-Statistic	-3.5781***	0.0002	-3.7331***	0.0001		
	Panel rho-Statistic	2.7201***	0.0033	3.2640***	0.0005		
	Panel PP-Statistic	1.0050	0.1575	0.1945	0.4229		
	Panel ADF-Statistic	0.8431	0.1996	0.2148	0.4150		
	<i>Between-dimension test statistics</i>					Yes	Yes
	Group rho-Statistic	3.9440***	0.0000	4.0159***	0.0000		
	Group PP-Statistic	2.1339**	0.0164	0.4390	0.3303		
	Group ADF-Statistic	1.9572**	0.0252	0.5202	0.3015		
LnHHI	<i>Within dimension test statistics</i>					Yes	Yes
	Panel v-Statistic	-3.0612***	0.0011	-3.9430***	0.0000		
	Panel rho-Statistic	2.0098**	0.0222	2.1392**	0.0162		
	Panel PP-Statistic	-3.2024***	0.0007	-4.4477***	0.0000		

	Panel ADF-Statistic	-3.1723***	0.0008	-4.4092***	0.0000		
	<i>Between-dimension test statistics</i>					Yes	Yes
	Group rho-Statistic	3.1285***	0.0009	3.0970***	0.0010		
	Group PP-Statistic	-2.5935***	0.0048	-3.9271***	0.0000		
	Group ADF-Statistic	-1.8853**	0.0297	-3.5162***	0.0002		
Westerlund panel-data cointegration test^c							
MEC	Group-mean variance-ratio (VR) statistic	-0.6685	0.2519	-0.5389	0.2950	No	No
	Panel VR statistic	-0.1910	0.4243	-0.9495	0.1712		
LnQ	Group-mean variance-ratio (VR) statistic	1.4666*	0.0712	1.7333**	0.0415	Yes	Yes
	Panel VR statistic	-0.0015	0.4994	-0.3891	0.3486		
LnV	Group-mean variance-ratio (VR) statistic	1.6882**	0.0457	3.2083***	0.0007	Yes	Yes
	Panel VR statistic	0.2364	0.4065	1.1823	0.1185		
LogSrellog	Group-mean variance-ratio (VR) statistic	-0.1430	0.4431	-0.0756	0.4699	No	No
	Panel VR statistic	-0.5942	0.2762	-0.6173	0.2685		
LnSeff	Group-mean variance-ratio (VR) statistic	2.2086**	0.0136	2.5991***	0.0047	Yes	Yes
	Panel VR statistic	-0.2509	0.4009	-0.0800	0.4681		
LnN	Group-mean variance-ratio (VR) statistic	2.4685***	0.0068	2.6222***	0.0044	Yes	Yes
	Panel VR statistic	0.4350	0.3318	0.9505	0.1709		
Lnn	Group-mean variance-ratio (VR) statistic	2.5111***	0.0060	2.6321***	0.0042	Yes	Yes
	Panel VR statistic	0.4280	0.3343	0.9642	0.1675		
LnHHI	Group-mean variance-ratio (VR) statistic	0.1658	0.4342	0.8092	0.2092	No	No
	Panel VR statistic	-0.3550	0.3613	0.7190	0.2361		

Source: Estimated by the author and data processed with Stata 15.

Note: 1. ^{a, b} H0: No cointegration; Ha: All panels are cointegrated. Lag selection is based on BIC.

^c H0: No cointegration; Ha: Some panels are cointegrated.

2. ***, **, * : significance levels of 1%, 5%, and 10%, respectively.

APPENDIX 5.G. Granger causality test

Table 5.7: Panel Granger non-causality test (Dumitrescu and Hurlin test (2012))

(Lags tested: 1 to 4)

	Null Hypothesis	Statistic	Bootstrap critical values			Null Hypothesis	Statistic	Bootstrap critical values			Causality direction
			10%	5%	1%			10%	5%	1%	
MEC	MOP does not Granger-cause MEC					MEC does not Granger-cause MOP					
	INRr	-0.3161	1.5521	2.3860	4.7654	INRr	-0.4050	1.4594	2.1409	4.2162	
	MB	3.9343**	1.9382	2.4982	4.2991	MB	-0.0716	1.3247	1.8870	3.4021	MB → MEC
	LnEXR	-0.4959	1.8239	2.6614	6.2151	LnEXR	0.9660	1.6479	1.8704	3.8136	
	GDPPr	1.6738	1.8647	2.5420	4.9381	GDPPr	0.6245	2.2032	3.3956	6.8051	
	CPI	-0.9592	1.7932	1.7932	6.1664	CPI	1.6804*	1.3905	2.3639	3.9447	CPI ← MEC
	LnTBR	-0.4810	1.6787	2.4122	3.7775	LnTBR	1.4393*	1.5516	1.9414	3.7733	LnTBR ← MEC
	LnMAC	-0.3454	2.2294	2.2294	4.7324	LnMAC	-0.0818	1.6655	2.9060	6.3645	
	FIG	2.6571**	1.7945	2.1826	3.7996	FIG	0.0118	1.4023	1.9576	3.4859	FIG → MEC
LnQ	MOP does not Granger-cause LnQ					LnQ does not Granger-cause MOP					
	INRr	-0.2720	2.3307	3.1573	5.3463	INRr	1.5855	2.4958	3.0220	5.3917	
	MB	3.8744**	1.3230	3.2929	5.4020	MB	1.0979	2.3309	2.9997	5.8038	MB → LnQ
	LnEXR	0.6304	3.6226	4.6954	8.0676	LnEXR	-0.4527	3.6549	5.0357	8.1164	
	GDPPr	-0.1762	1.8424	2.8998	5.1653	GDPPr	0.6879	2.4496	3.6260	6.4728	
	CPI	2.8699	2.2611	3.5017	7.3643	CPI	1.2952	2.7687	3.5371	5.4705	
	LnTBR	0.0515	2.5337	3.9569	5.2736	LnTBR	0.7894	2.9307	3.9395	6.1735	
	LnMAC	6.5149	3.1400	4.7763	6.6253	LnMAC	-0.2518	5.2016	6.5617	8.8690	
	FIG	1.9489	1.6635	2.5339	3.6288	FIG	-0.0356	3.0497	4.1580	6.3888	
LnV	MOP does not Granger-cause LnV					LnV does not Granger-cause MOP					
	INRr	1.4281	2.5558	3.4068	5.4097	INRr	-0.8302	2.8702	3.4618	5.1914	
	MB	3.1993**	1.2828	1.9269	4.5020	MB	1.0142	2.3658	3.1381	6.0761	MB → LnV

	LnEXR	0.8523	3.7847	5.1813	6.9501	LnEXR	0.7143	3.4873	4.7245	6.2661	
	GDPPr	-0.7122	1.7948	2.6784	5.2734	GDPPr	1.6037	2.5712	3.5880	5.6825	
	CPI	8.3669***	2.6397	3.4397	5.0985	CPI	2.8749	2.3561	3.2504	6.1399	CPI → LnV
	LnTBR	0.1182	2.9495	3.2681	5.6370	LnTBR	0.2796	3.2822	4.1187	6.2385	
	LnMAC	13.4030***	4.0062	5.6428	9.5896	LnMAC	0.6664	4.3866	6.1174	8.5238	LnMAC → LnV
	FIG	1.0617	1.3284	1.9681	4.4249	FIG	-0.2394	2.6284	3.9645	7.3304	
LogSrellog	MOP does not Granger-cause LogSrellog					LogSrellog does not Granger-cause MOP					
	INRr	2.2834*	1.6494	2.3489	3.9823	INRr	-0.4124	1.5678	2.3891	3.4947	INRr → LogSrellog
	MB	0.1227	1.4750	1.9928	3.8258	MB	1.0111	1.6815	2.4735	3.8740	
	LnEXR	1.7556	2.3053	3.2070	5.3494	LnEXR	-0.7474	2.2101	3.0166	4.1940	
	GDPPr	2.2065*	1.7220	2.3877	3.8871	GDPPr	0.0155	1.4560	2.3277	3.8756	GDPPr → LogSrellog
	CPI	2.2926*	1.8074	2.3600	3.7767	CPI	1.1684	1.7108	2.4190	4.0650	CPI → LogSrellog
	LnTBR	2.7166*	1.9020	2.9021	5.1509	LnTBR	-0.1510	1.9108	2.3436	3.7298	LnTBR → LogSrellog
	LnMAC	6.3930***	2.4903	3.5758	7.2260	LnMAC	3.6428**	1.3281	2.1325	3.5222	LnMAC ↔ LogSrellog
	FIG	4.1674***	1.6843	2.3549	4.0541	FIG	-0.3844	1.6539	2.8890	3.6555	FIG → LogSrellog
LnSeff	MOP does not Granger-cause LnSeff					LnSeff does not Granger-cause MOP					
	INRr	-0.7661	1.5377	2.2814	4.4676	INRr	0.8666	2.5553	2.9989	6.1430	
	MB	0.5011	1.6914	2.4167	3.7688	MB	2.5056**	1.3671	1.9034	2.9810	MB ← LnSeff
	LnEXR	1.3570	2.3514	3.2179	4.0543	LnEXR	8.1622***	2.9670	3.6948	5.4423	LnEXR ← LnSeff
	GDPPr	-0.0993	1.6016	2.1353	3.3320	GDPPr	4.7530**	2.2017	3.2793	5.6609	GDPPr ← LnSeff
	CPI	4.3907***	1.9423	2.6208	4.0719	CPI	4.9852	2.1673	2.9216	6.5543	CPI → LnSeff
	LnTBR	-0.3236	1.9733	2.6149	4.7485	LnTBR	3.7689**	2.7394	3.1561	5.8593	LnTBR ← LnSeff
	LnMAC	4.0410**	2.6996	3.2880	5.2981	LnMAC	7.6090**	3.6267	4.7431	7.8507	LnMAC ↔ LnSeff
	FIG	2.3503*	1.7671	2.4184	4.0108	FIG	-0.4653	2.4147	3.4844	5.1180	FIG → LnSeff
LnN	MOP does not Granger-cause LnN					LnN does not Granger-cause MOP					
	INRr	0.5219	2.6059	3.0794	5.1055	INRr	6.1819***	2.4013	3.4446	4.5365	INRr ← LnN
	MB	3.1303*	2.1680	3.3650	4.2347	MB	1.0224	2.2353	3.6867	4.8933	MB → LnN
	LnEXR	0.1054	3.5209	4.4650	6.4256	LnEXR	2.1130	4.2212	5.1726	8.0921	

	GDPPr	-0.2307	1.6376	2.2871	4.6932	GDPPr	1.4494	2.7832	3.7173	6.4592	
	CPI	1.2546	1.9461	3.1865	5.2287	CPI	2.8234*	2.6457	3.6941	5.3538	CPI ← LnN
	LnTBR	0.1904	2.5136	3.5641	4.7383	LnTBR	0.3761	3.5745	4.3075	7.3281	
	LnMAC	6.1380**	3.8406	4.8970	8.6818	LnMAC	-0.4479	5.5500	7.0538	10.6289	LnMAC → LnN
	FIG	0.4974	2.1155	2.8593	4.3580	FIG	4.2130**	2.3970	2.9978	5.0845	FIG ← LnN
Lnn	MOP does not Granger-cause Lnn					Lnn does not Granger-cause MOP					
	INRr	0.5708	2.4433	3.5751	4.6203	INRr	6.7309***	2.5362	3.4346	5.5433	INRr ← Lnn
	MB	3.0981**	1.7702	2.4606	4.2774	MB	1.1544	2.3682	3.1707	4.7282	MB → Lnn
	LnEXR	0.2581	3.6063	4.7768	6.6915	LnEXR	1.3106	4.2382	5.8747	8.9443	
	GDPPr	-0.2773	1.8461	2.5350	4.1879	GDPPr	1.1435	2.6429	3.2751	5.4247	
	CPI	1.2653	2.1701	3.1265	4.4644	CPI	2.8442*	2.6791	3.4234	5.4560	CPI ← Lnn
	LnTBR	0.2813	2.3696	3.3866	5.4864	LnTBR	0.4006	3.4651	4.3321	6.6619	
	LnMAC	6.3912**	3.9013	5.2443	7.3618	LnMAC	-0.4718	5.1584	6.1596	9.3033	LnMAC → LnN
	FIG	0.5742	1.9592	2.6951	4.9627	FIG	4.3225**	2.4736	3.4849	4.5659	FIG ← LnN
LnHHI	MOP does not Granger-cause LnHHI					LnHHI does not Granger-cause MOP					
	INRr	-0.2644	2.0201	2.6804	4.3893	INRr	2.4058*	1.8091	2.7100	4.4935	INRr ← LnHHI
	MB	0.7270	1.7679	2.1912	4.7075	MB	3.0015**	1.8836	2.8346	5.8811	MB ← LnHHI
	LnEXR	1.6335	2.5944	3.3645	5.1572	LnEXR	2.2209*	2.1342	2.9036	5.2074	LnEXR ← LnHHI
	GDPPr	2.9466**	1.8305	2.4159	3.7822	GDPPr	5.9742***	1.4429	2.1268	6.1525	GDPPr ↔ LnHHI
	CPI	-0.2192	1.9456	2.7361	3.8896	CPI	1.7296	2.1689	3.1200	4.8704	
	LnTBR	6.3658***	1.9705	2.8526	5.0324	LnTBR	3.9773**	2.2979	3.3026	4.7527	LnTBR ↔ LnHHI
	LnMAC	22.9942***	2.4951	3.4517	4.8072	LnMAC	4.5056**	1.8565	2.1721	4.8631	LnMAC ↔ LnHHI
	FIG	0.0103	1.7621	2.8751	3.7939	FIG	2.6847*	2.1239	2.7555	5.2541	FIG ← LnHHI

Source: Estimated by the author and data processed with Stata 15.

Note: 1. p-values computed using 650 bootstrap replications.

2. ***, **, * : significance levels of 1%, 5%, and 10%, respectively highlighted in red.



Cheung (1990), Mok (1993) in Hong Kong; Rahman et al. (2009) in Malaysia; Wang (2010) in China; etc.

Wongbangpo & Sharma (2002) in ASEAN-5 countries; Gagnon & Gimet (2013) in the U.S., the Eurozone and Canada; Smimou & Khallouli (2015) in 10 Eurozone countries and the UK; Li et al. (2019), Sun & Yuan (2021) in China; etc.



Friedman (1988)

Mc Cornac (1991) in Japan; Choudhry (1996) in Canada and the U.S.; Kwon & Shin (1999) in South Korea; Ali et al. (2010) in Pakistan; Abdelbaki (2013) in Bahrain; Khan et al. (2017) in Pakistan; etc.

Real activity theory

Bulmash & Trivoli (1991), Picha (2017) in the U.S; Sellin (2001); Wongbangpo & Sharma (2002) in ASEAN-5 countries; Pilinkus & Boguslauskas (2009) in Lithuania; Büyüksalvarci & Abdİoğlu (2010) in Turkey; Mohamadpour et al. (2012) in Malaysia; Bissoon et al. (2016) in growing stock markets; Khan et al. (2017) in Pakistan; Sahu & Pandey (2020) in India; etc.

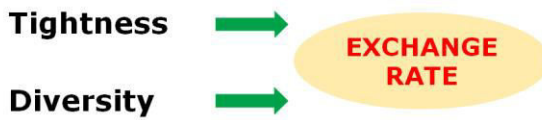

Stock-oriented model (Frankel, 1983; Branson and Henderson, 1985)

Ajayi et al. (1998) in eight Asian emerging markets; Granger et al. (2000) in Asian countries; Pan et al. (2001), Zhao (2010) in China; Wongbangpo & Sharma (2002) in ASEAN-5 countries; Smyth & Nandha (2003) in South Asia; Diamandis & Drakos (2011) in four Latin America countries; Parsva & Lean (2011) in six Middle Eastern financial markets; Lin (2012) in Asian Middle emerging markets; Chkili & Nguyen (2014) in BRICS countries; Huy (2016) in Vietnam; etc.



Feedback hypothesis

Wongbangpo & Sharma (2002) in ASEAN-5 countries; Hondroyiannis et al. (2005), Athanasios & Antonios (2012) in Greece; Apergis et al. (2007) in 15 OECD and 50 non-OECD countries; Oskooe (2010) in Iran; Olweny et al. (2011) in Kenya; Cheng (2012) in Taiwan; Ray (2012) in India; Pan & Mishra (2018) in China; Ho (2019) in South Africa; etc.

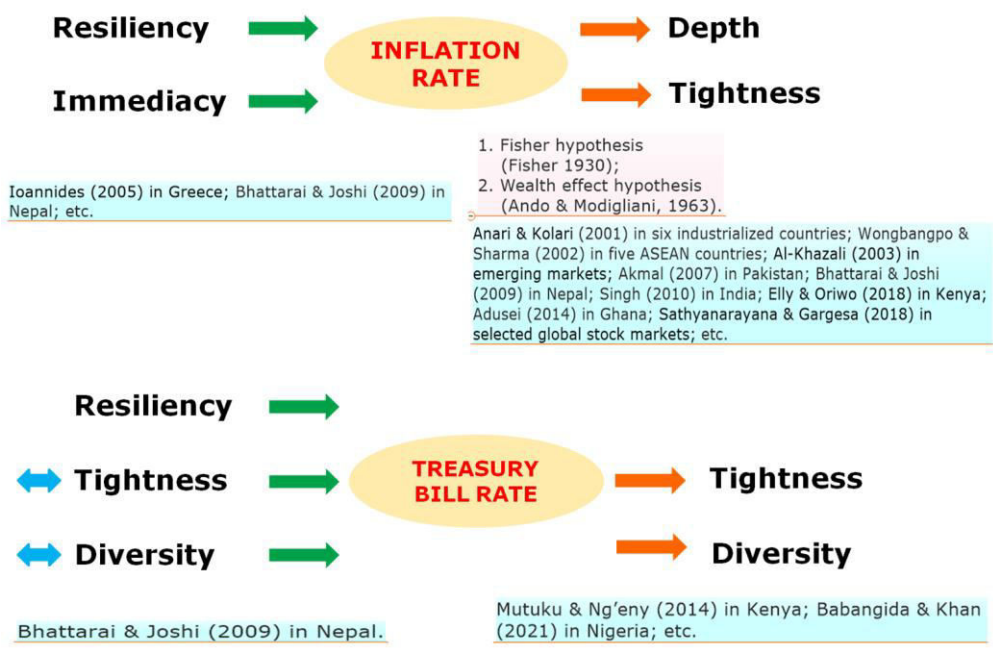

Figure 5.5: Granger causality between MOP and SML in seven selected countries of EMEs from 2000 to 2018

Source: Estimated by the author and data processed with Stata 15.

APPENDIX 5.H. CS-ECM estimation

Table 5.8: Dynamic Common Correlated Effects Estimator - Mean Group (CS-ECM) for MEC

(Lags tested: 1 to 2)

1. MEC								
Error Correction			INRr	MB	LnEXR	GDPr	CPI	LnTBR
Short run est. (D.)		Coef.	-0.1599	-0.0091	-0.3913	-0.2188*	-0.0828	1.4725
		z	-0.59	-0.44	-0.18	-1.65	-1.17	1.21
		P> z	0.555	0.657	0.854	0.099	0.243	0.225
LnMAC		Coef.	-0.7066	-0.8075	0.1877	0.2937	-0.5354	0.1665
		z	-1.05	-1.09	0.17	0.39	-0.71	0.53
		P> z	0.295	0.277	0.866	0.695	0.478	0.599
FIG		Coef.	4.3481	2.1247*	3.3264*	2.0710*	0.9088	0.0648
		z	1.17	1.82	3.3264	1.65	0.59	0.04
		P> z	0.242	0.068	0.084	0.099	0.553	0.965
Long run est.		Coef.	0.1976	0.0393	-1.8595	0.2218	-0.0971	40.7024
		z	1.25	1.39	-0.51	0.81	-0.50	1.08
		P> z	0.213	0.166	0.611	0.416	0.620	0.281
LnMAC		Coef.	-1.7661	0.4614	0.3122	0.7041**	2.0827	-25.0395
		z	-0.92	1.34	0.48	2.17	1.17	-0.98
		P> z	0.356	0.180	0.632	0.030	0.242	0.327
FIG		Coef.	-8.4333	-0.3729	-3.9402*	-1.6314	3.1832	66.3738
		z	-1.49	-0.21	-1.90	-1.30	0.62	1.03
		P> z	0.136	0.831	0.057	0.195	0.535	0.305
L.MEC		Coef.	-0.7540**	-1.0565***	-0.8082***	-1.2116***	-1.3204***	-0.8253**
		z	-2.28	-9.87	-2.76	-3.33	-5.26	-2.29
		P> z	0.023	0.000	0.006	0.001	0.000	0.022
R-squared			0.06	0.11	0.11	0.08	0.07	0.09
R-squared (MG)			0.99	0.98	0.97	0.98	0.99	0.98

F(98, 14)			2.34	1.10	1.21	1.74	2.04	1.42
Prob > F			0.04	0.45	0.36	0.12	0.07	0.24
CD Statistic			-1.03	-0.48	-1.77	-2.33	-2.03	-1.27
p-value			0.3049	0.6313	0.0764	0.0198	0.0427	0.2055
Estimation of Cross-Sectional Exponent (alpha)	residuals	alpha	0.6240	0.6176	0.6173	0.7041	0.6362	0.6240

Source: Estimated by the author and data processed with Stata 15.

- Note: 1. $0.5 \leq \alpha < 1$ implies strong cross sectional dependence.
2. SE and CI bootstrapped with 100 repetitions.
3. ***, **, * : significance levels of 1%, 5%, and 10%, respectively highlighted in red.

Table 5.9: Dynamic Common Correlated Effects Estimator - Mean Group (CS-ECM) for LnQ

(Lags tested: 1 to 2)

2. LnQ								
Error Correction			INRr	MB	LnEXR	GDPr	CPI	LnTBR
Short run est. (D.)		Coef.	-0.0372	-0.0517	0.4199	0.0751	0.1432	0.4906
		z	-1.14	-0.92	0.09	0.71	0.85	0.40
		P> z	0.254	0.358	0.931	0.481	0.394	0.687
LnMAC		Coef.	0.1202	-0.6098	0.8058	-0.1027	0.0480	0.4263
		z	0.36	-0.47	0.83	-0.37	0.24	0.75
		P> z	0.719	0.638	0.405	0.710	0.808	0.456
FIG		Coef.	0.5709	-2.1020**	-4.9172***	0.0228	-3.2486	-0.5705
		z	0.38	-2.32	-3.35	0.02	-0.99	-0.86
		P> z	0.707	0.020	0.001	0.985	0.322	0.391
Long run est.		Coef.	-0.5523	-0.0117	1.9911	0.0226	0.0253	-0.9313
		z	-0.91	-0.45	0.81	0.29	0.32	-1.16
		P> z	0.364	0.656	0.416	0.770	0.749	0.247
	LnMAC	Coef.	-4.1670	-0.7304	-2.3205	-0.2951	0.3357*	-0.3439

		z	-0.80	-0.58	-0.85	-0.45	1.81	-0.40
		P> z	0.421	0.565	0.393	0.655	0.070	0.690
	FIG	Coef.	-26.0664	0.7649	3.2421	0.1005	-0.1859	-0.1470
		z	-1.09	0.44	1.10	0.07	-0.07	-0.11
		P> z	0.277	0.658	0.270	0.943	0.947	0.915
L.LnQ		Coef.	-0.5221*	-2.2063	-0.7931	-1.0592***	-0.3245	-1.0180***
		z	-1.76	-1.55	-1.35	-4.93	-0.64	-5.45
		P> z	0.078	0.121	0.178	0.000	0.523	0.000
R-squared			0.17	0.20	0.16	0.17	0.12	0.06
R-squared (MG)			0.97	0.97	0.97	0.97	0.98	0.99
F(98, 14)			0.70	0.58	0.77	0.72	1.03	2.38
Prob > F			0.84	0.94	0.78	0.82	0.51	0.04
CD Statistic			-0.19	-1.74	-1.76	-0.81	-0.09	-1.63
p-value			0.8467	0.0818	0.0783	0.4182	0.9308	0.1030
Estimation of Cross-Sectional Exponent (alpha)	residuals	alpha	0.6861	0.6238	0.6679	0.5802	0.5413	0.6763

Source: Estimated by the author and data processed with Stata 15.

- Note: 1. $0.5 \leq \alpha < 1$ implies strong cross sectional dependence.
2. SE and CI bootstrapped with 100 repetitions.
3. ***, **, * : significance levels of 1%, 5%, and 10%, respectively highlighted in red.

Table 5.10: Dynamic Common Correlated Effects Estimator - Mean Group (CS-ECM) for LnV

(Lags tested: 1 to 2)

3. LnV								
Error Correction			INRr	MB	LnEXR	GDPr	CPI	LnTBR
Short run est. (D.)	Coef.		0.0130	-0.0123**	4.0053	-0.0352	0.0379	-0.2465
	z		0.23	-2.55	1.34	-0.82	1.36	-0.46
	P> z		0.818	0.011	0.180	0.414	0.175	0.645

	LnMAC	Coef.	0.0495	-0.3582	0.5259	0.2241	-0.4160	0.0677
		z	0.28	-1.02	1.11	0.65	-0.78	0.15
		P> z	0.779	0.307	0.269	0.514	0.437	0.879
	FIG	Coef.	-0.9754	-0.0691	-0.3926	-1.2287	1.0606	-0.1659
		z	-1.48	-0.15	-0.72	-1.21	0.67	-0.24
		P> z	0.140	0.884	0.471	0.227	0.506	0.809
Long run est.		Coef.	0.0464	0.0189*	1.9822	-0.0710	0.0241	-0.2078
		z	1.27	1.93	0.35	-0.34	0.20	-0.91
		P> z	0.205	0.054	0.727	0.732	0.844	0.361
	LnMAC	Coef.	-0.0197	0.2137	4.7699	-1.0414	0.7117	-0.0249
		z	-0.05	0.46	0.94	-1.56	1.24	-0.05
		P> z	0.964	0.648	0.345	0.120	0.215	0.958
	FIG	Coef.	1.2804	0.1294	-16.0422	0.3617	-0.3747	0.6484
		z	1.39	0.18	-1.01	0.47	-0.15	0.69
		P> z	0.166	0.857	0.314	0.637	0.881	0.492
L.LnV		Coef.	-1.0438***	-1.4613***	-0.8638***	-0.8073***	-0.9535***	-1.5383***
		z	-7.05	-6.85	-3.64	-3.21	-5.89	-7.35
		P> z	0.000	0.000	0.000	0.001	0.000	0.000
R-squared			0.04	0.13	0.03	0.02	0.04	0.02
R-squared (MG)			0.99	0.95	0.99	0.99	0.99	0.99
F(98, 14)			3.64	0.96	4.96	6.34	3.29	9.01
Prob > F			0.00	0.58	0.00	0.00	0.01	0.00
CD Statistic			4.35	0.73	1.25	-1.89	2.79	0.84
p-value			0.0000	0.4671	0.2127	0.0583	0.0052	0.3994
Estimation of Cross-Sectional Exponent (alpha)	residuals	alpha	0.5862	0.5	0.5841	0.5864	0.6252	0.5770

Source: Estimated by the author and data processed with Stata 15.

- Note: 1. $0.5 \leq \alpha < 1$ implies strong cross sectional dependence.
2. SE and CI bootstrapped with 100 repetitions.
3. ***, **, * : significance levels of 1%, 5%, and 10%, respectively highlighted in red.

Table 5.11: Dynamic Common Correlated Effects Estimator - Mean Group (CS-ECM) for LogSrellog

(Lags tested: 1 to 2)

4. LogSrellog								
Error Correction			INRr	MB	LnEXR	GDPr	CPI	LnTBR
Short run est. (D.)		Coef.	0.1592	-0.0006	4.8548	0.0904	0.0397	1.5324***
		z	0.94	-0.04	1.58	0.44	0.23	3.92
		P> z	0.346	0.970	0.114	0.662	0.814	0.000
LnMAC		Coef.	-0.3641	-0.0910	0.3532	-0.7107	-0.8478	0.6189**
		z	-0.53	-0.13	0.51	-0.64	-1.09	2.03
		P> z	0.596	0.898	0.611	0.521	0.275	0.042
FIG		Coef.	-0.5624	1.2390	3.4048*	0.4799	1.4686	0.3576
		z	-0.16	0.81	1.89	0.21	0.56	0.25
		P> z	0.871	0.420	0.059	0.832	0.576	0.800
Long run est.		Coef.	-0.2381	-0.0696**	-7.7261	-0.5966	0.1578	-1.0905
		z	-0.61	-2.32	-1.12	-0.64	0.74	-1.15
		P> z	0.542	0.020	0.264	0.522	0.456	0.251
LnMAC		Coef.	3.8589	-0.3845	0.2006	-3.9118	1.4204	0.1832
		z	0.96	-0.46	0.09	-1.20	1.53	0.17
		P> z	0.335	0.643	0.929	0.232	0.127	0.862
FIG		Coef.	0.6033	6.0632	-4.0655	2.2290	-7.5661	-2.6538
		z	0.04	0.87	-1.20	0.58	-1.61	-0.90
		P> z	0.970	0.382	0.231	0.560	0.107	0.367
L. LogSrellog		Coef.	-0.6845***	-0.7067***	-1.0262***	-0.9248***	-1.1294***	-1.2726***
		z	-4.02	-3.88	-5.34	-2.82	-6.08	-6.87
		P> z	0.000	0.000	0.000	0.005	0.000	0.000
R-squared			0.08	0.14	0.07	0.13	0.07	0.09
R-squared (MG)			0.97	0.95	0.98	0.96	0.98	0.97
F(98, 14)			1.57	0.88	1.82	0.92	1.78	1.46
Prob > F			0.17	0.66	0.10	0.62	0.11	0.22

CD Statistic			0.46	-2.13	-1.70	-0.19	-1.28	-0.87
p-value			0.6436	0.0333	0.0898	0.8458	0.2016	0.3857
Estimation of Cross-Sectional Exponent (alpha)	residuals	alpha	0.6485	0.5804	0.5792	0.6155	0.5892	0.6755

Source: Estimated by the author and data processed with Stata 15.

- Note: 1. $0.5 \leq \alpha < 1$ implies strong cross sectional dependence.
2. SE and CI bootstrapped with 100 repetitions.
3. ***, **, * : significance levels of 1%, 5%, and 10%, respectively highlighted in red.

Table 5.12: Dynamic Common Correlated Effects Estimator - Mean Group (CS-ECM) for LnSeff

(Lags tested: 1 to 2)

5. LnSeff								
Error Correction			INRr	MB	LnEXR	GDPr	CPI	LnTBR
Short run est. (D.)		Coef.	-0.0599*	0.0058	-0.3594	-0.0249	0.0326	0.1435
		z	-1.73	0.90	-0.45	-0.73	1.56	0.77
		P> z	0.083	0.367	0.651	0.467	0.118	0.442
LnMAC		Coef.	0.1968	0.2713	0.1481	0.2276	0.2835	0.5577
		z	0.54	0.83	0.41	0.60	1.11	1.03
		P> z	0.592	0.408	0.684	0.549	0.268	0.305
FIG		Coef.	0.9227	0.4749	-1.0408	-0.6467*	-0.0743	0.1107
		z	1.54	0.48	-1.32	-1.76	-0.26	0.19
		P> z	0.123	0.630	0.187	0.078	0.798	0.848
Long run est.		Coef.	-0.4010	-0.3216	1.0952	0.2771	-0.1639*	1.0010
		z	-0.78	-0.86	0.54	0.93	-1.74	1.20
		P> z	0.438	0.391	0.591	0.353	0.082	0.230
LnMAC		Coef.	1.6939	8.4000	0.2628	-0.2034	-1.7616	0.6150
		z	0.93	1.11	0.47	-0.24	-1.41	0.63
		P> z	0.355	0.265	0.637	0.814	0.158	0.527

	FIG	Coef.	8.2159	-11.3882	2.2706	-0.3884	0.9363	2.0065
		z	0.86	-0.82	1.07	-0.10	0.22	1.39
		P> z	0.387	0.415	0.283	0.918	0.824	0.164
L. LnSeff		Coef.	-0.8685***	-0.4603*	-1.1624***	-0.8439**	-0.3864*	-0.4780
		z	-3.37	-1.78	-4.55	-2.42	-1.71	-0.62
		P> z	0.001	0.075	0.000	0.016	0.088	0.534
R-squared			0.11	0.06	0.02	0.04	0.06	0.12
R-squared (MG)			0.98	0.99	1.00	0.99	0.99	0.98
F(98, 14)			1.17	2.11	6.31	3.68	2.38	1.09
Prob > F			0.39	0.06	0.00	0.00	0.03	0.45
CD Statistic			1.68	1.58	-0.42	-0.76	-1.26	3.47
p-value			0.0928	0.1140	0.6710	0.4491	0.2059	0.0005
Estimation of Cross-Sectional Exponent (alpha)	residuals	alpha	0.5398	0.6148	0.6452	0.6251	0.5906	0.5945

Source: Estimated by the author and data processed with Stata 15.

- Note: 1. $0.5 \leq \alpha < 1$ implies strong cross sectional dependence.
2. SE and CI bootstrapped with 100 repetitions.
3. ***, **, * : significance levels of 1%, 5%, and 10%, respectively highlighted in red.

Table 5.13: Dynamic Common Correlated Effects Estimator - Mean Group (CS-ECM) for LnN

(Lags tested: 1 to 2)

6. LnN								
Error Correction			INRr	MB	LnEXR	GDPr	CPI	LnTBR
Short run est. (D.)		Coef.	-0.0193	0.0077	-1.8402	0.0052	0.0194	0.36924
		z	-0.51	0.90	-0.98	0.14	0.72	0.80
		P> z	0.607	0.367	0.326	0.888	0.474	0.424
	LnMAC	Coef.	0.3923	0.3007	-0.5645	0.5851	-0.0767	-0.0418

		z	0.75	1.64	-0.88	1.41	-0.18	-0.13
		P> z	0.456	0.100	0.380	0.158	0.856	0.895
	FIG	Coef.	-0.6379	-0.8777**	0.4113	-0.8125	-0.3100	-0.4175
		z	-0.54	-1.97	0.57	-1.22	-0.47	-0.77
		P> z	0.587	0.049	0.571	0.222	0.637	0.439
Long run est.		Coef.	-0.0557	-0.0354	19.0792	0.1060	0.0341	-2.1440
		z	-0.54	-0.85	1.33	1.38	0.26	-1.46
		P> z	0.592	0.397	0.184	0.167	0.798	0.145
	LnMAC	Coef.	-5.4500**	-0.1084	-0.2764	-0.6355	8.2865	-1.8918
		z	-1.97	-0.28	-0.08	-0.71	0.98	-0.88
		P> z	0.049	0.780	0.936	0.476	0.329	0.380
	FIG	Coef.	7.1216**	1.5545	4.4195	-4.8328	-3.8388	0.5603
		z	2.13	0.72	1.48	-0.82	-1.01	0.27
		P> z	0.033	0.472	0.139	0.410	0.312	0.789
L. LnN		Coef.	-0.5352**	-0.5742***	-0.8681***	-0.7910***	-0.1198	-0.8029***
		z	-2.17	-5.18	-2.93	-3.55	-0.18	-3.47
		P> z	0.030	0.000	0.003	0.000	0.855	0.001
R-squared			0.10	0.16	0.04	0.16	0.08	0.04
R-squared (MG)			0.98	0.97	0.99	0.97	0.99	0.99
F(98, 14)			1.36	0.75	3.76	0.74	1.74	3.12
Prob > F			0.27	0.79	0.00	0.81	0.12	0.01
CD Statistic			-1.87	0.89	-1.77	-0.29	-1.28	1.88
p-value			0.0615	0.3733	0.0772	0.7684	0.2018	0.0596
Estimation of Cross-Sectional Exponent (alpha)	residuals	alpha	0.6927	0.6433	0.6773	0.6136	0.5412	0.6273

Source: Estimated by the author and data processed with Stata 15.

- Note: 1. $0.5 \leq \alpha < 1$ implies strong cross sectional dependence.
2. SE and CI bootstrapped with 100 repetitions.
3. ***, **, * : significance levels of 1%, 5%, and 10%, respectively highlighted in red.

Table 5.14: Dynamic Common Correlated Effects Estimator - Mean Group (CS-ECM) for Lnn

(Lags tested: 1 to 2)

7. Lnn								
Error Correction			INRr	MB	LnEXR	GDPr	CPI	LnTBR
Short run est. (D.)		Coef.	-0.0479	0.0085	-1.6080	0.0144	0.0402	0.2341
		z	-0.88	0.97	-0.90	0.43	1.21	0.49
		P> z	0.381	0.333	0.366	0.665	0.226	0.624
LnMAC		Coef.	0.3827	0.2273	-0.5479	0.5319	-0.8043	-0.0560
		z	0.81	1.16	-0.90	1.30	-0.71	-0.18
		P> z	0.421	0.247	0.369	0.194	0.478	0.858
FIG		Coef.	0.0811	-0.7461*	0.3906	-0.8561	0.1266	-0.3227
		z	0.07	-1.66	0.55	-1.23	0.13	-0.64
		P> z	0.942	0.096	0.582	0.218	0.900	0.521
Long run est.		Coef.	-2.7851	-0.0360	7.3410	0.0769	-0.1023*	-5.7803
		z	-0.75	-0.74	0.60	0.99	-1.65	-1.18
		P> z	0.454	0.462	0.548	0.323	0.099	0.237
LnMAC		Coef.	-1.9138	0.0501	3.1580*	-0.9295	-1.6260	-6.1840
		z	-0.09	0.10	1.78	-1.23	-1.13	-0.90
		P> z	0.926	0.918	0.075	0.220	0.259	0.366
FIG		Coef.	58.2522	0.1742	7.0257	1.8267	-3.8029	5.8297
		z	0.94	0.18	1.26	1.10	-1.26	1.05
		P> z	0.347	0.856	0.209	0.272	0.208	0.292
L. Lnn		Coef.	-0.5144**	-0.6072***	-0.8804***	-0.9060***	0.7764	-0.7130***
		z	-1.99	-5.64	-3.10	-4.16	0.53	-2.74
		P> z	0.047	0.000	0.002	0.000	0.598	0.006
R-squared			0.09	0.14	0.05	0.16	0.06	0.04
R-squared (MG)			0.98	0.97	0.99	0.96	0.99	0.99
F(98, 14)			1.41	0.87	2.96	0.78	2.37	3.17
Prob > F			0.24	0.68	0.01	0.77	0.04	0.01

CD Statistic			-1.76	-1.57	-1.98	-0.29	-1.05	1.01
p-value			0.0788	0.1162	0.0472	0.7696	0.2933	0.3105
Estimation of Cross-Sectional Exponent (alpha)	residuals	alpha	0.6867	0.6797	0.6779	0.6319	0.6246	0.6479

Source: Estimated by the author and data processed with Stata 15.

- Note: 1. $0.5 \leq \alpha < 1$ implies strong cross sectional dependence.
2. SE and CI bootstrapped with 100 repetitions.
3. ***, **, * : significance levels of 1%, 5%, and 10%, respectively highlighted in red.

Table 5.15: Dynamic Common Correlated Effects Estimator - Mean Group (CS-ECM) for LnHHI

(Lags tested: 1 to 2)

8. LnHHI								
Error Correction			INRr	MB	LnEXR	GDPr	CPI	LnTBR
Short run est. (D.)		Coef.	0.0001	-0.0217	-1.0489	0.0019	0.0279	-0.4747
		z	0.00	-0.89	-1.36	0.04	0.87	-1.27
		P> z	0.997	0.371	0.175	0.971	0.382	0.203
LnMAC		Coef.	-0.1890	-0.0673	0.0694	-0.1461	0.1671	0.1540
		z	-1.10	-0.16	1.18	-0.37	1.05	1.27
		P> z	0.273	0.875	0.236	0.713	0.293	0.205
FIG		Coef.	0.2797	0.4234	-0.4737	-0.1791	0.1667	-0.8590
		z	0.69	0.36	-0.79	-0.66	0.21	-1.05
		P> z	0.489	0.722	0.431	0.511	0.836	0.294
Long run est.		Coef.	0.1316	-0.0392*	-15.3551	0.1130	0.0761	0.4766**
		z	1.42	-1.80	-0.94	0.87	0.88	2.27
		P> z	0.156	0.072	0.345	0.383	0.380	0.023
LnMAC		Coef.	0.8087	-0.3885	0.5589	-0.1950	-0.0913	-0.2500
		z	0.67	-1.14	1.52	-1.08	-0.51	-1.08
		P> z	0.504	0.253	0.128	0.279	0.609	0.279

	FIG	Coef.	-2.4727**	1.4204	1.9741	0.2985	1.1338	0.2390
		z	-2.07	1.20	0.98	0.30	1.37	0.44
		P> z	0.039	0.230	0.327	0.766	0.171	0.657
L. LnHHI		Coef.	-0.5120*	-0.3619	-0.8657***	-0.3231	-1.2821***	-1.1117**
		z	-1.95	-0.95	-2.80	-0.66	-3.05	-1.96
		P> z	0.051	0.344	0.005	0.510	0.002	0.050
R-squared			0.07	0.11	0.10	0.04	0.07	0.14
R-squared (MG)			0.98	0.97	0.97	0.99	0.98	0.96
F(98, 14)			1.96	1.22	1.36	3.76	1.98	0.86
Prob > F			0.08	0.36	0.27	0.00	0.08	0.69
CD Statistic			-0.27	2.04	-0.42	-2.00	-0.18	2.26
p-value			0.7889	0.0412	0.6755	0.0455	0.8603	0.0239
Estimation of Cross-Sectional Exponent (alpha)	residuals	alpha	0.61705	0.6154	0.5886	0.6307	0.5776	0.5

Source: Estimated by the author and data processed with Stata 15.

- Note: 1. $0.5 \leq \alpha < 1$ implies strong cross sectional dependence.
2. SE and CI bootstrapped with 100 repetitions.
3. ***, **, * : significance levels of 1%, 5%, and 10%, respectively highlighted in red.